User Manual for the

Porometer

type AP4



AP4-UM-3

AT

DELTA-T DEVICES

Using this manual

This manual provides information necessary to correctly install and operate the Delta-T Porometer type AP4.

AP4 POROMETER USER MANUAL

Document code: AP4-UM-3 Revised January 2004

Editor: Nick Webb
Authors: Tom Bragg
Nick Webb
Richard Spencer
John Wood
Chris Nicholl
Edmund Potter

Artwork: Nick Webb
Anne Simpson

Delta-T Devices Ltd,
128 Low Road,
Burwell,
Cambridge CB5 0EJ
England

Phone: +44 1638 742922
Fax: +44 1638 743155
E-mail: tech.support@delta-t.co.uk

THE AP4 DESIGN TEAM :

Chris Nicholl : Project leader and software
Tom Bragg : Electronic hardware
John Wood : Theory, head design & testing
Edmund Potter : Testing & quality assurance
Richard Spencer : Mechanical design
Nick Webb : User manual, project scheduling.
Kaz Burek : Data retrieval software & software quality assurance.
Alasdair Philips : Head PCB layout.

ACKNOWLEDGEMENTS

We would like to thank John Harris for helping with the design of the software menu and the Department of Trade and Industry for a grant towards the design of the AP4.

Ian Woodward and Colin Black are thanked for testing early prototypes. John Monteith and Gaylon Campbell are thanked for their work on the theory.

John Monteith and Edward Arnold Publishers are thanked for permission to reprint an extract from *Principles of Environmental Physics*. Jonathan Price is thanked for his advice in *How to write a computer manual*, published by Benjamin/Cummings. The Director of ICRISAT, India, is thanked for permission to reproduce an independent test report.

COPYRIGHT

Copyright © 1991 Delta-T Devices Ltd., 128 Low Rd, Burwell, Cambridge CB5 0EJ, England. All rights reserved. Under the copyright laws, this book may not be copied, in whole or in part, without the written consent of Delta-T Devices. Under the law, copying includes translation into another language.

CONTENTS

1.	INTRODUCTION	5
2.	WARNINGS	7
3.	UNPACKING AND INSTALLATION	8
4.	SETTING UP AND SHUTTING DOWN	10
5.	HOW TO DRIVE THE POROMETER	13
	5.1 LAYOUT	14
	5.2 CONTROL KEYS	18
	5.4 MENU NAVIGATION	23
6.	HOW TO TAKE READINGS	27
	6.1 PREPARATION	27
	6.2 A TYPICAL MEASUREMENT SESSION	28
	6.3 HOW TO READ	29
	6.4 CALIBRATION	39
	6.5 REVIEW	57
	6.6 OUTPUT	61
7.	PLANNING YOUR EXPERIMENT	71
	7.1 CHECKS	72
	7.2 HOW MANY READINGS TO TAKE	73
	7.3 MEMORY USAGE	73
	7.4 EXAMPLE PLAN	74
	7.5 HOW TO CALCULATE AVAILABLE MEMORY	75
8.	TUTORIAL	77
	8.1 HINTS AND TIPS	78
	8.2 RESISTANCE AND CONDUCTANCE UNITS	85
	8.3 BAROMETRIC PRESSURE	87
	8.4 POROMETRY AND STOMATA	89
<hr/>		
	TECHNICAL SECTION	91
9.	SPECIFICATIONS	93
10.	HOW TO SERVICE	97
	10.1 BATTERY	98
	10.2 CASE AND CHASSIS : HOW TO UNDO THEM	101
	10.3 CUP : HOW TO CHANGE IT	104
	10.4 DESICCANT : HOW TO CHANGE IT	105
	10.5 EPROM : HOW TO CHANGE IT	107
	10.6 HEAD : HOW TO DISASSEMBLE	110
	10.7 PUMP : HOW TO CHANGE IT	111
	10.8 LIGHT SENSOR : CALIBRATION	112
	10.9 RH SENSOR : CALIBRATION	113
	10.10 THERMISTORS : CALIBRATION	115
	10.11 SOFTWARE CRASHES : HOW TO RESET	115
	10.12 TROUBLE SHOOTING	117
11.	HOW IT WORKS	119
	11.1 WHAT HAPPENS IN THE HEAD	121
	11.2 HOW THE RESULTS ARE CALCULATED	123
	11.3 HOW THE ELECTRONICS WORK	141
12.	CIRCUIT DIAGRAMS	145
13.	COMPONENTS & CONNECTORS	153
14.	SPARES, CONSUMABLES & ACCESSORIES	159
15.	SERVICE AND GUARANTEE	161
	APPENDIX A : DESIGN OF THE AP4	163
	APPENDIX B : TEST RESULTS	171
	REFERENCES	183
	INDEX	184
	APPENDIX C : AP4 RETRIEVE FOR WINDOWS SOFTWARE	
	APPENDIX D : AP4 HEAD DESIGN DETAIL	
	APPENDIX E : AP4 BATTERY DESIGN CHANGE	

1. INTRODUCTION

The AP4 is a cycling porometer. It is used for measuring the stomatal resistance of plant leaves. This is a measure of the resistance to loss of water vapour through the stomata and is an indicator of the physiological state of the plant.

Stomata are sensitive to light, carbon dioxide, pollutants and water stress and pathogens. The AP4 provides an important tool for unravelling and understanding the intricate web of mechanisms that control stomatal behaviour. It also has an important role to play in the comparison of the performance of different varieties and breeds of crops in response to environmental variations and stresses.

The instrument works by measuring the time it takes for a leaf to release sufficient water vapour to change the relative humidity in a small chamber by a fixed amount. This is compared with a calibration plate of known resistance in order to derive the stomatal resistance or conductance of the leaf.

The method is well established. It is supported by a good theoretical understanding of a cycling porometer (Monteith, Campbell & Potter, 1988) and backed up by our considerable manufacturing experience of this type of instrument. Many hundreds of Delta-T cycling porometers have been in use throughout the world over the last decade.

The design has been significantly improved by the use of a microprocessor to release the user from the burden of frequently replotting calibration graphs. The process is now much simpler and quicker. It also needs doing less frequently because the AP4 can correct for changes in temperature. Readings are automatically converted into units of resistance or conductance, and can be annotated, displayed, saved and output to a computer or printer. Menu driven software, a 40 character by 8 line liquid crystal display and dedicated function buttons are thoughtfully integrated to make the use of the instrument as intuitive and simple as possible.

Beginners can be up and running quickly without a deep knowledge of all the available options, whereas more experienced users have easy access to the default settings via the use of a context sensitive SET button. A HELP button displays context-sensitive help messages, and a laminated single page Quick Guide is provided which you can tuck in the carrying bag.

A single button on the porometer head permits one-handed use of the instrument in the field. The software is arranged so that successive readings can be taken, evaluated and stored just by pressing this one button. Stable readings are denoted by a the sound of a double "beep", so you do not need to look at the instrument at all.

Two porometer cup shapes are provided for different leaf shapes. The head and case are relatively light, and a padded shoulder bag with a waist-strap is provided as standard.

2. WARNINGS

HEAD UNIT

DO NOT USE ORGANIC SOLVENTS ON OR NEAR THE RH SENSOR

PROTECT THE RH SENSOR FROM SMOKE

PROTECT THE RH SENSOR FROM SHOCK

AVOID TOUCHING THE RH SENSOR

AVOID CONTAMINATING THE CALIBRATION PLATE

AVOID WARMING THE HEAD OR CALIBRATION PLATE BY EXCESSIVE HANDLING OR EXPOSURE TO THERMAL RADIATION

DO NOT LEAVE A LEAF OR THE CALIBRATION PLATE IN THE HEAD WHEN THE AP4 IS NOT CYCLING

WHOLE INSTRUMENT

AVOID STORAGE OR USE ABOVE 80% RH

PROTECT THE AP4 FROM WATER

AVOID DEEP DISCHARGE OF BATTERY.

RECHARGE A FULLY DISCHARGED BATTERY IMMEDIATELY.

DO NOT CONNECT BATTERY CHARGER TO THE WRONG MAINS VOLTAGE

YOURSELF

*DO NOT EAT THE DESICCANT (or any other part of the porometer !**!)*

YOUR ENVIRONMENT

The battery is lead-acid. Dispose of it safely, as both lead and the acid gel are toxic.

3. UNPACKING AND INSTALLATION

Upon delivery you should receive a packing list with the porometer. Check you have everything.

YOU SHOULD HAVE

One AP4 including one head unit inside the case.

(Some customers may have ordered a spare head)

One padded carrying bag with waist and shoulder straps.

This User Manual.

One Quick Guide (can be tucked in between the padded bag and the case).

One Universal RS232 Ribbon Cable and Adapter

One AP4 Battery Charger.

One 3½ and one 5¼ in disks with data retrieval software.

One Consumables kit – paper pads, tape, 500 g silica gel, silica gel tube, cup seal, cup gasket, cup insert, two screws.

OPTIONAL ACCES SORIES

One AP4 Spares Kit, type PSK1, see list in Chapter 13

Extra AP4 Consumables Kit, type PCK1.

One barometer, wristwatch type PBR1.

Spare sensor head, type PSH1.

Spare AP4 re-chargeable battery, type PSB1

YOU WILL ALSO NEED

Access to a computer and/or printer back at the laboratory

Scissors

White paper towel or tissue

PACKING LIST

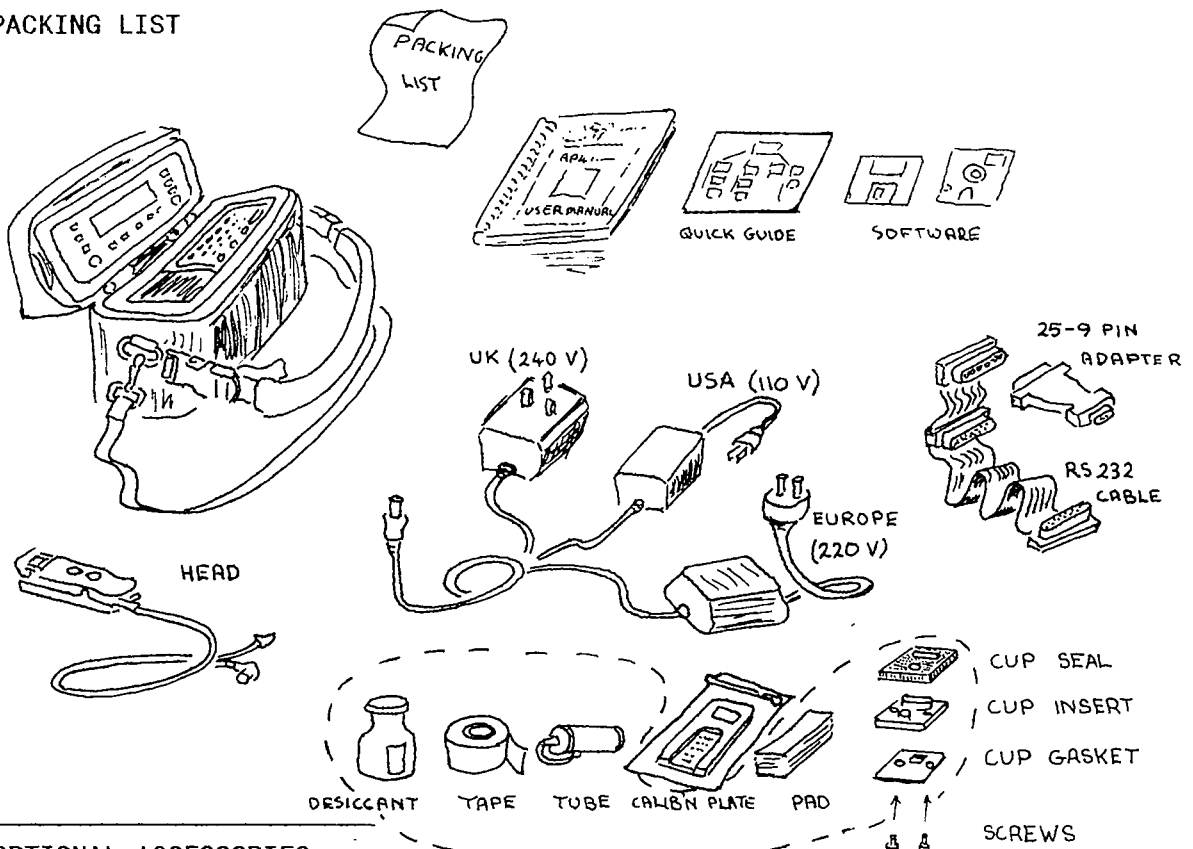

OPTIONAL ACCESSORIES

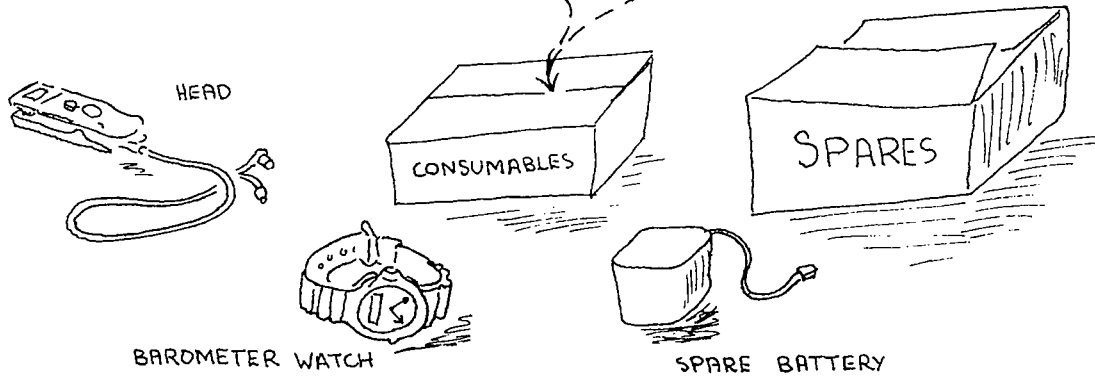

YOU WILL ALSO NEED

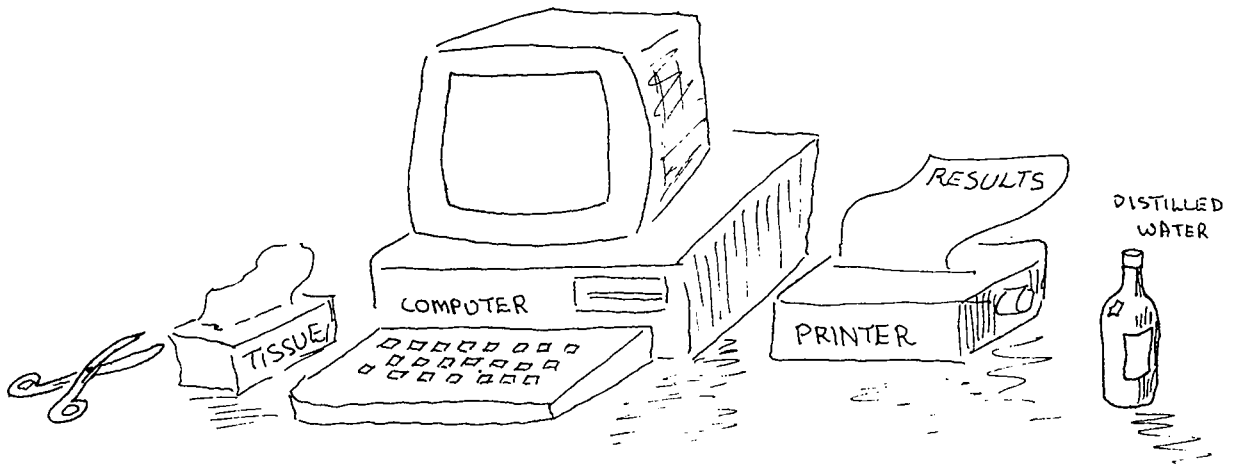

4. SETTING UP AND SHUTTING DOWN

SETTING UP

Renew desiccant if pink (see Chapter 9)

Plug head unit into chassis.

Press **ON**

Turn black LCD knob to optimise the contrast on the screen.

Check display for **battery low** warning - recharge if necessary.
(See Chapter 10.1)

Check display for **available memory**. If memory is low, someone was using the AP4 and has left readings in it. To free up memory, either erase the readings or output them to a printer or computer (See Chapter 6.4)

SHUTTING DOWN

Short term - shutting down for less than 2 weeks

Press OFF button twice.

Place head and head cable in pocket provided.

Zip up case.

Protect from dust, humidity greater than 80 %RH, smoke and organic solvent fumes and other pollutants.

Long term

Charge battery. Recharge battery every year or more frequently if storing above 20 °C (See Chapter 10.1)

Protect from dust, humidity greater than 80 %RH, smoke and organic solvent fumes and other sulphurous pollutants.

Setting up

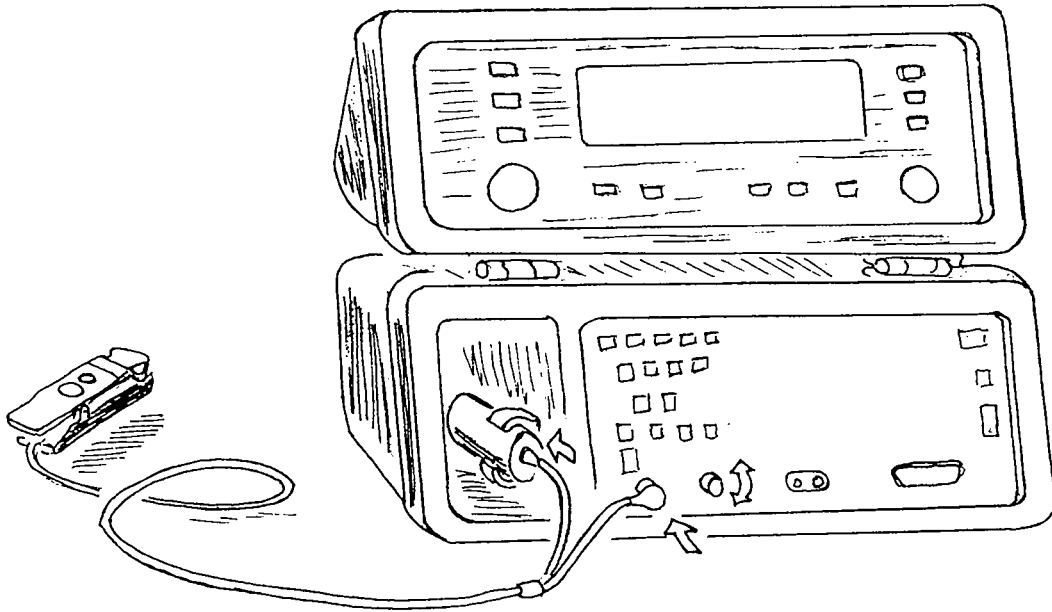

Shutting down

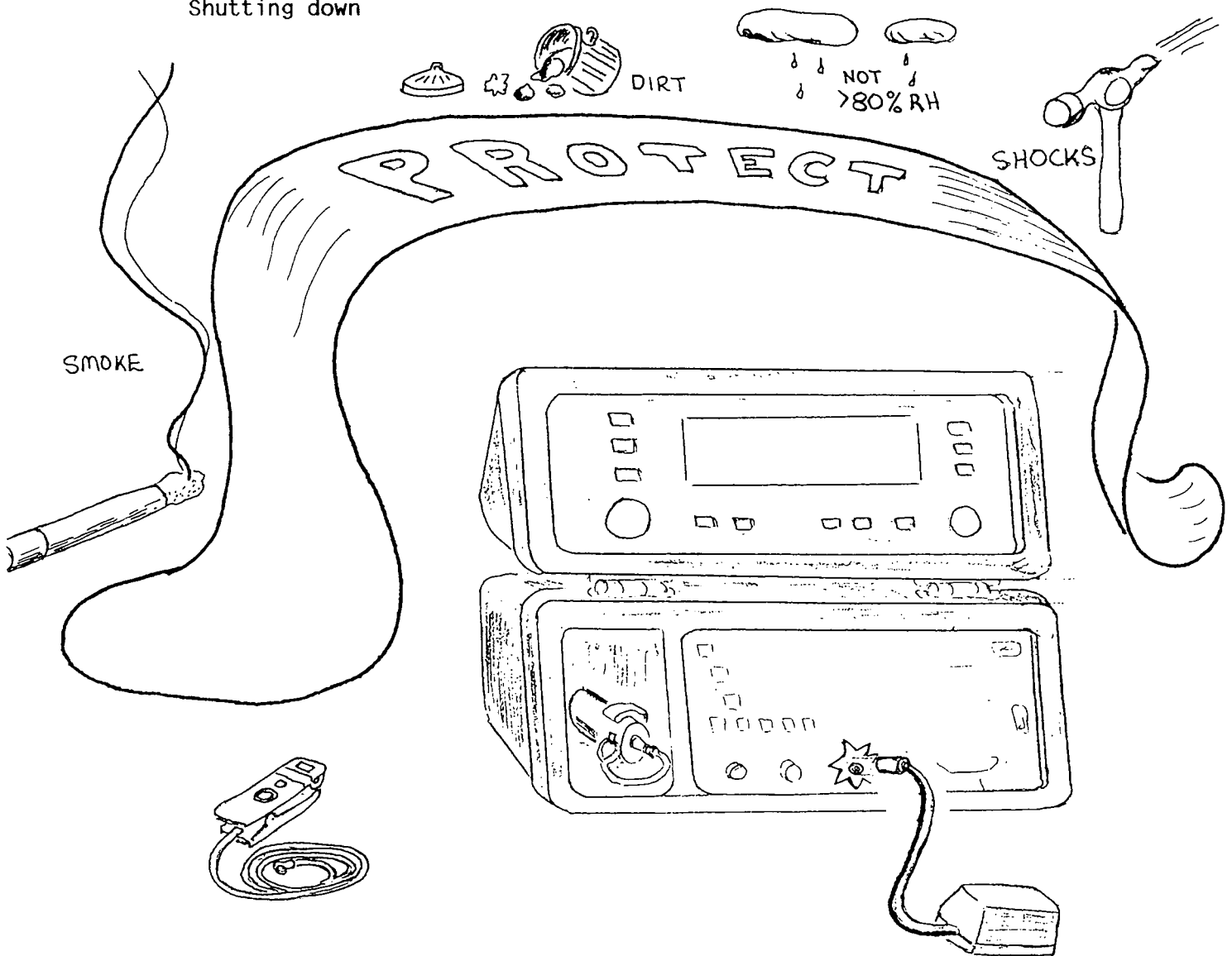

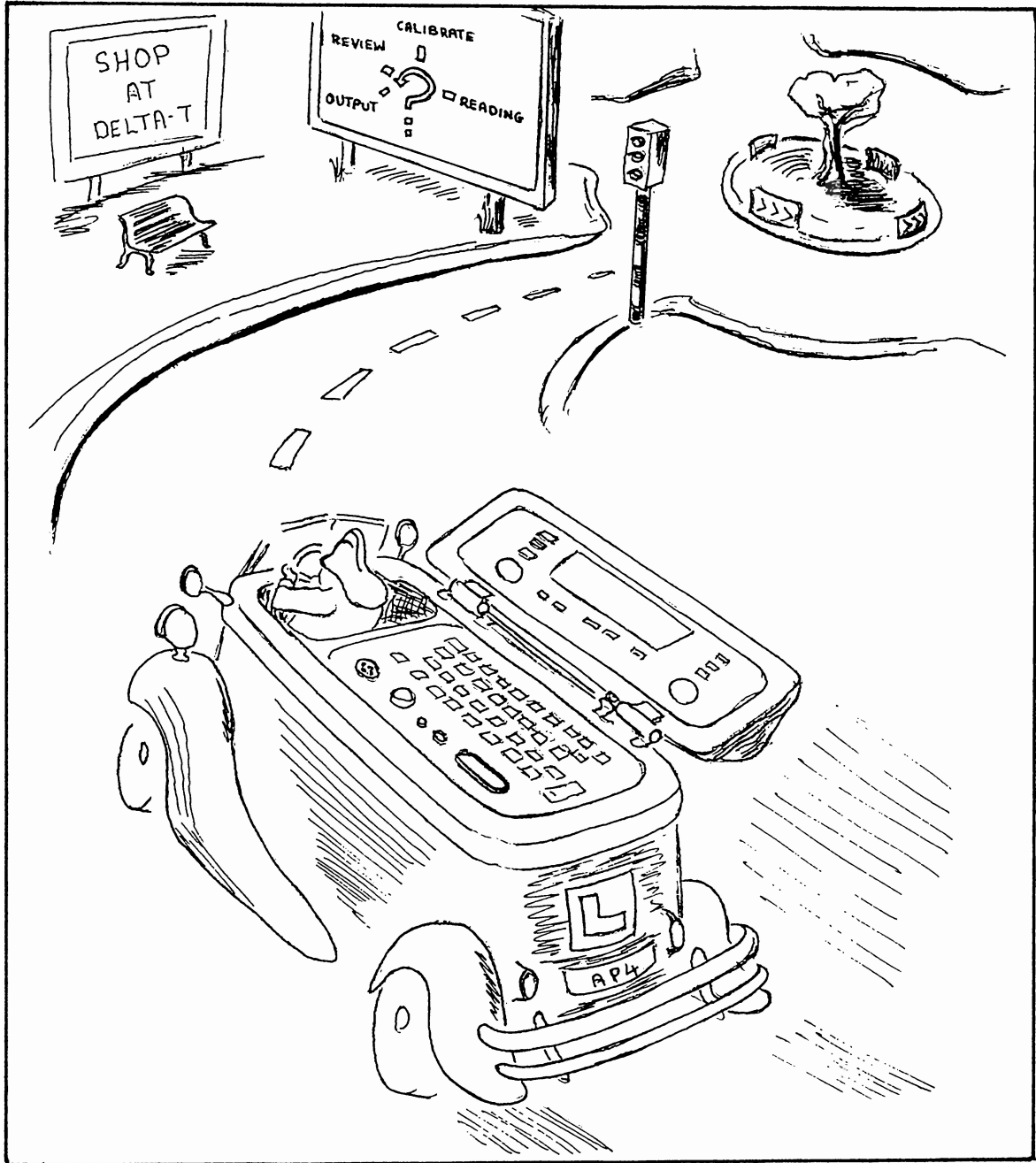

5. HOW TO DRIVE THE POROMETER

Before you drive a car, you need to know where the controls are, and what they do. The AP4 is conceptually similar. Controls are provided to navigate through the menus, whereby you select and activate the programs which control the behaviour of the porometer.

We begin with a description of the layout, then inspect each control in detail. The Chapter ends with maps showing all the journeys you can take through the software. Unlike a car journey, nothing drastic will happen if you press the wrong button. So feel free to jump to the next Chapter "How to take readings" and learn by trial and error if you wish.

CONTENTS

■ LAYOUT	5.1
The Porometer head unit	
The Lid	
The Display	
The Keyboard	
■ CONTROLS	5.2
ON/OFF	
HELP	
EXIT	
GO	
>>	
SHIFT OFF	
SET	
+ & -	
■ MENU NAVIGATION	5.3
Beginners	
Advanced	
Settings options	

5.1 LAYOUT

THE POROMETER HEAD UNIT

Examine the head unit. It is like a large clothes peg, for clipping onto leaves. Identify the shiny mirrored surface of the RH sensor inside the cup. It is quite fragile and is also easily damaged by organic solvents. Next to it is a microchip thermistor, no bigger than a pin head. Opposite the cup a second microchip thermistor is buried in the translucent flexible silicon rubber pad. These measure the cup and leaf temperatures respectively.

One control button is mounted on the head, next to the light sensor.

The cable attached to the head contains a tube for air as well as signal wires. The tubing plugs into the container of silica gel desiccant crystals, located in the pocket to the left of the keyboard. These should be blue. The cable plugs into the head socket on the left of the keyboard.

THE HEAD UNIT

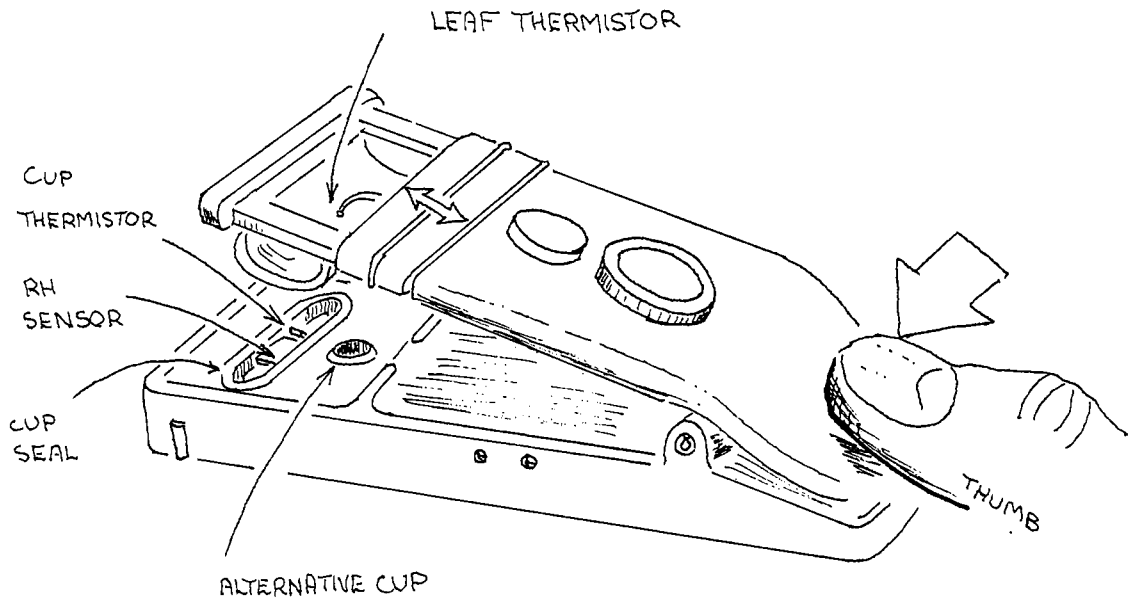
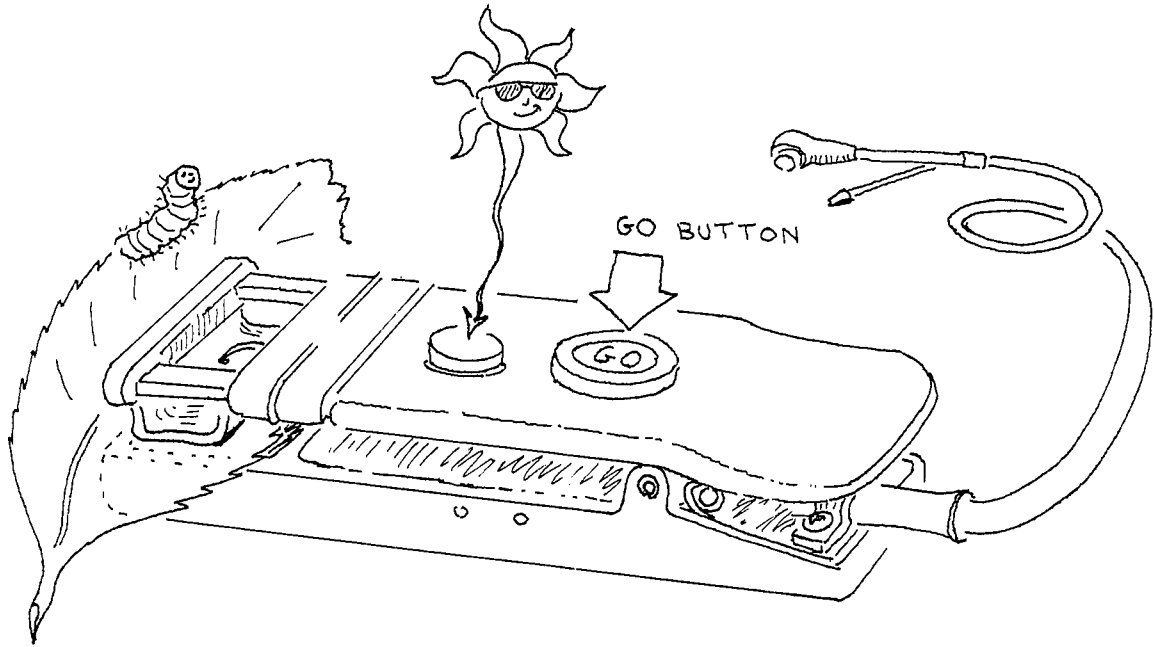

THE LID

The rest of the control keys are push buttons clustered around the display panel on the lid. The most frequently used keys are duplicated around both sides of the lid, to help both left and right-handed people.

The most important and useful button, GO, is also found on the porometer head. It does not matter which one you use.

THE DISPLAY

The main menu is displayed across the bottom of the screen when the porometer is turned on. Users familiar with menu driven computer programs should find the selection and activation of particular options to be fairly intuitive. Options are selected and activated using the >> and GO keys described below.

You can adjust the contrast with the LCD knob.

THE KEYBOARD

The standard QWERTY keyboard on the case of the porometer does not control the porometer at all. It is just used for adding optional notes to readings, and for entering the titles of groups of readings.

Below the keyboard, from left to right, are located the socket for the head lead, a control knob to adjust the screen contrast, an input socket with a red light for the battery charger, and an RS232C serial interface socket for sending data to a printer or computer.

Lid controls and Keyboard

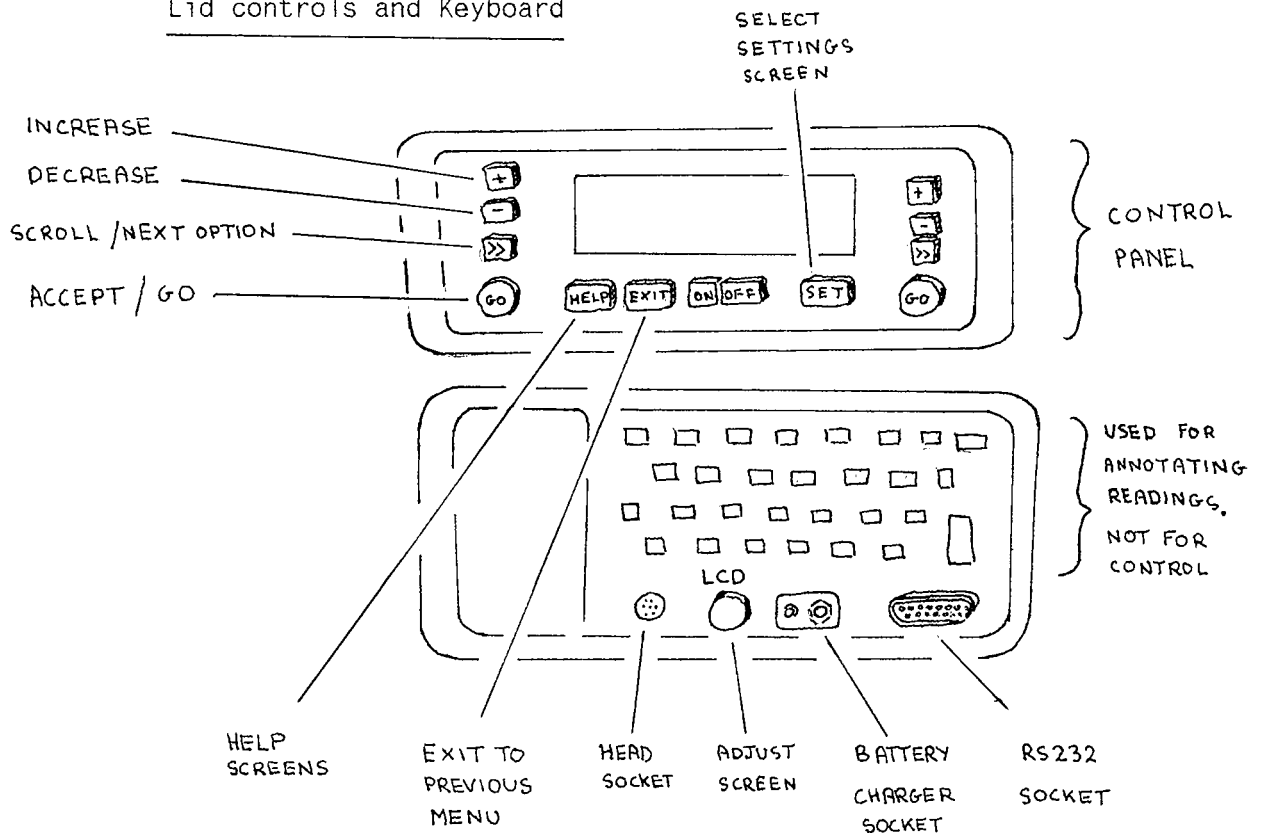

Software controls

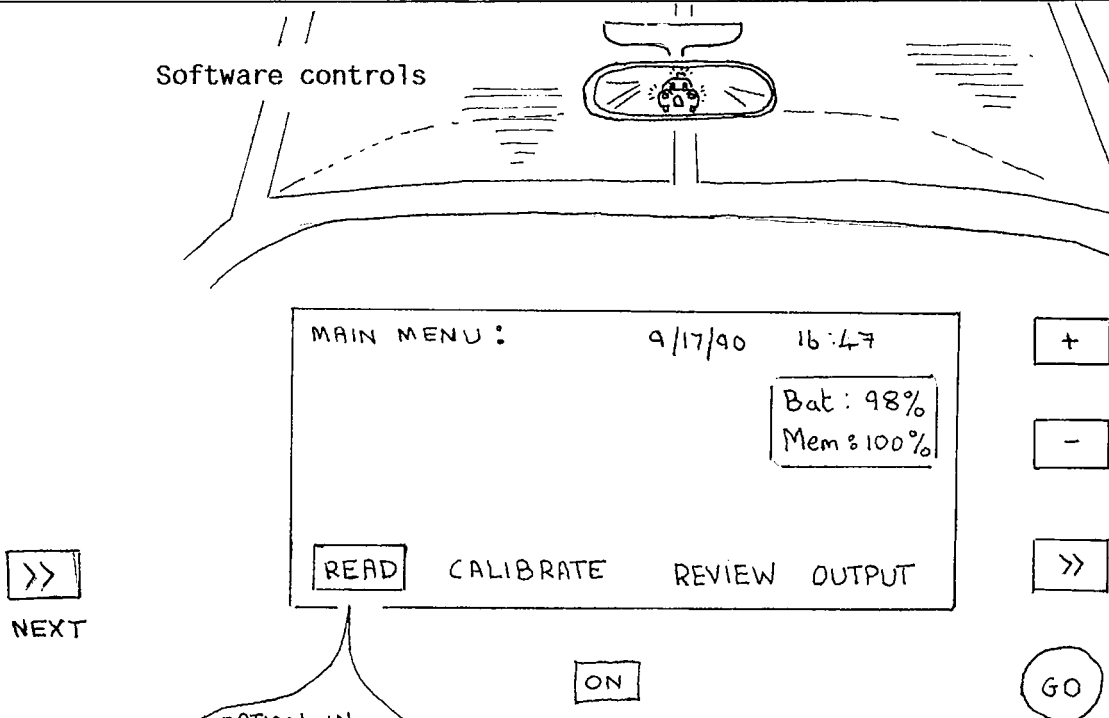

OPTION IN INVERSE VIDEO WILL BE SELECTED IF YOU PRESS GO

DRIVING THE POROMETER

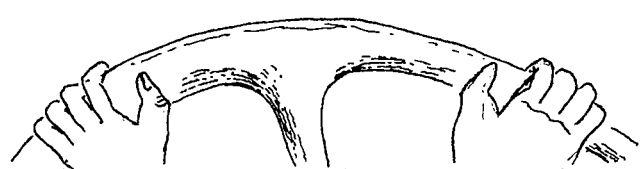

5.2 CONTROL KEYS

ON

ON KEY

OFF

OFF KEY

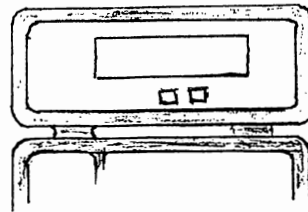

The ON and OFF key turn the instrument on and off.

Press OFF twice to turn off.

See also :

Warnings: Chapter 2
Setting up and shutting down : Chapter 4
Battery care and recharging : Chapter 10.1

HELP

HELP KEY

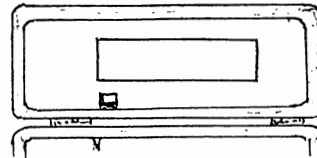

The HELP key provides context-sensitive information on what to do next. Up to 7 screens of help may be provided.

Press HELP again to read the next screen.

Press any other key to return to the program.

EXIT

EXIT KEY

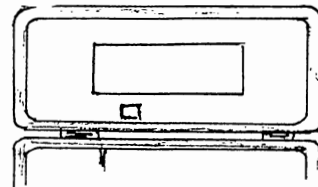

The EXIT key is used to leave a menu without selecting any option. The program returns to the next higher menu level.

Use it to go backwards.

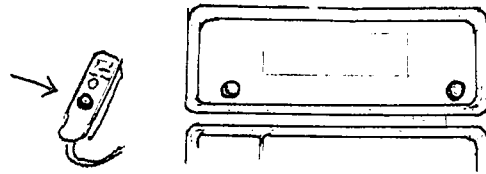
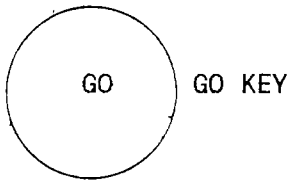

The GO key is duplicated, for left and right-handed people, on both sides of the lid display. The larger button on the porometer head is also a GO key.

It is an action key, causing the execution of the selected or default menu option.

Examples : ACCEPT a menu option
DO a suggested command
START a reading
STORE a reading

The meaning of the GO key is context sensitive.

During readings, the options on the display will cycle sequentially.

Example :

USER	POROMETER	
ACTION	ACTION	DISPLAY
-	-	OFF
Press ON	wake up	MAIN MENU
Press GO	select READ loop	INSERT LEAF
Insert leaf	waiting	" "
Press GO	START reading	READING CYCLE
Wait	continues	" "
Press GO	ACCEPTS reading	STORE READING
Press GO	STORES result	INSERT LEAF

THIS PERMITS ONE-HANDED OPERATION OF THE POROMETER

At any stage other options can be selected via the >> key or the previous menu can be selected via the EXIT key

If at any stage the porometer thinks that it is time to recalibrate it will remind you with a flashing display. This can occur after a long interval since the last calibration, after a large shift in the cup temperature or if the relative humidity cycling set point is altered. You can choose to ignore it if you wish, but the accuracy may suffer.



SCROLL KEY

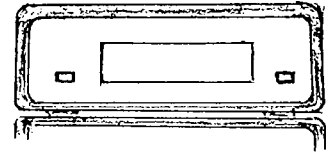

The scroll key can be used to step through all the available options on the screen.

Use it to move about the screen

Example

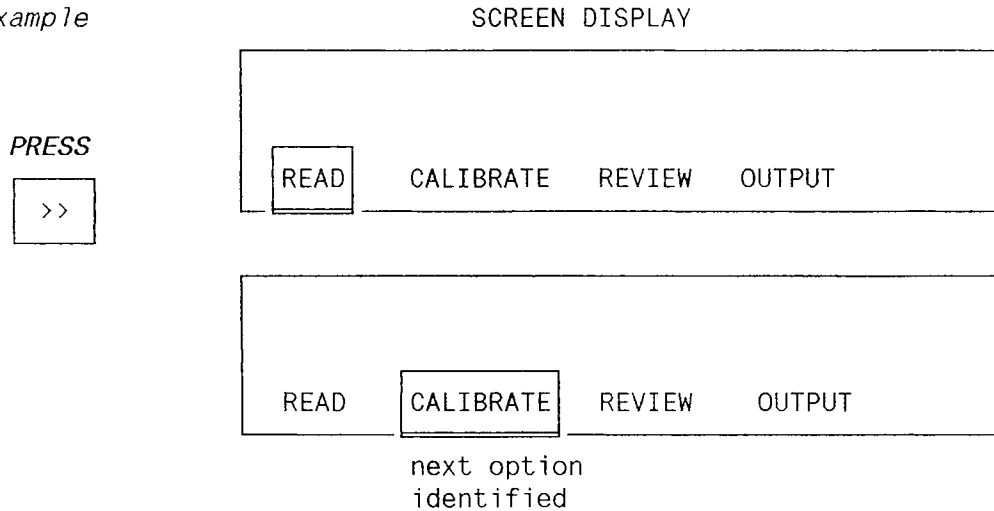

SHIFT OFF (together)

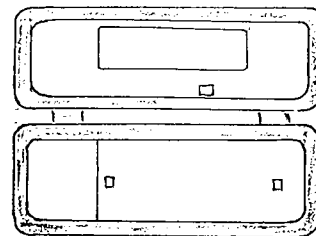

Beginners can ignore this.

Use this when replacing the AP4 head.

It gives access to the "Configure AP4 Head Screen".

Use it to install the appropriate calibration for a new light sensor and to zero the electronic circuit which measures the leaf-cup temperature difference.

See also :

- Light sensor calibration : chapter 10.8
- Thermistor calibration : chapter 10.10

Accessing the SET SCREEN will display three head calibration coefficients, used to characterise water absorption in the cup. These are automatically used to calculate the results. Only theoreticians and other experts will be interested in this.

See also :

- How the results are calculated : chapter 11.2

SET

SET KEY

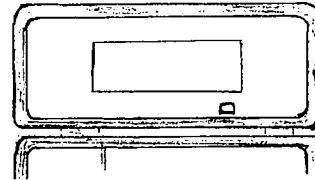

The SET key is used to set or change default values. It is context-sensitive, and depends on which menu is active.

Example
BEFORE

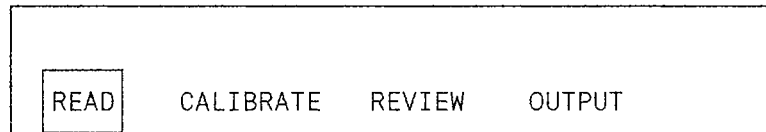

SET

AFTER

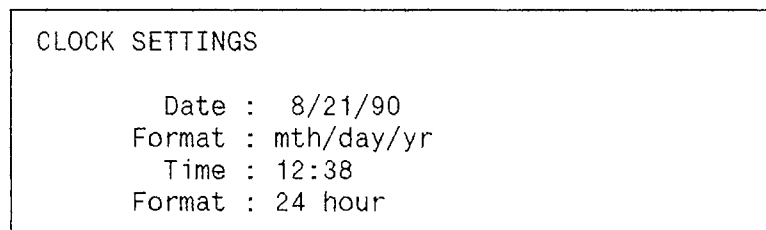

See also

Menu navigation : advanced, Chapter 5.3
Table of settings options, Chapter 5.3

+

PLUS KEY

-

MINUS KEY

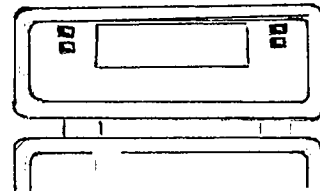

The plus and minus key are used to change default settings.

Example : To change the date

USER ACTION	POROMETER	
	ACTION	DISPLAY
-	asleep	off
Press ON	Wakes	MAIN MENU
Press SET	CLOCK SETTINGS Day of month shown in inverse video	
Press +	Day of month increments	
Press GO	Accepts change	returns to MAIN MENU

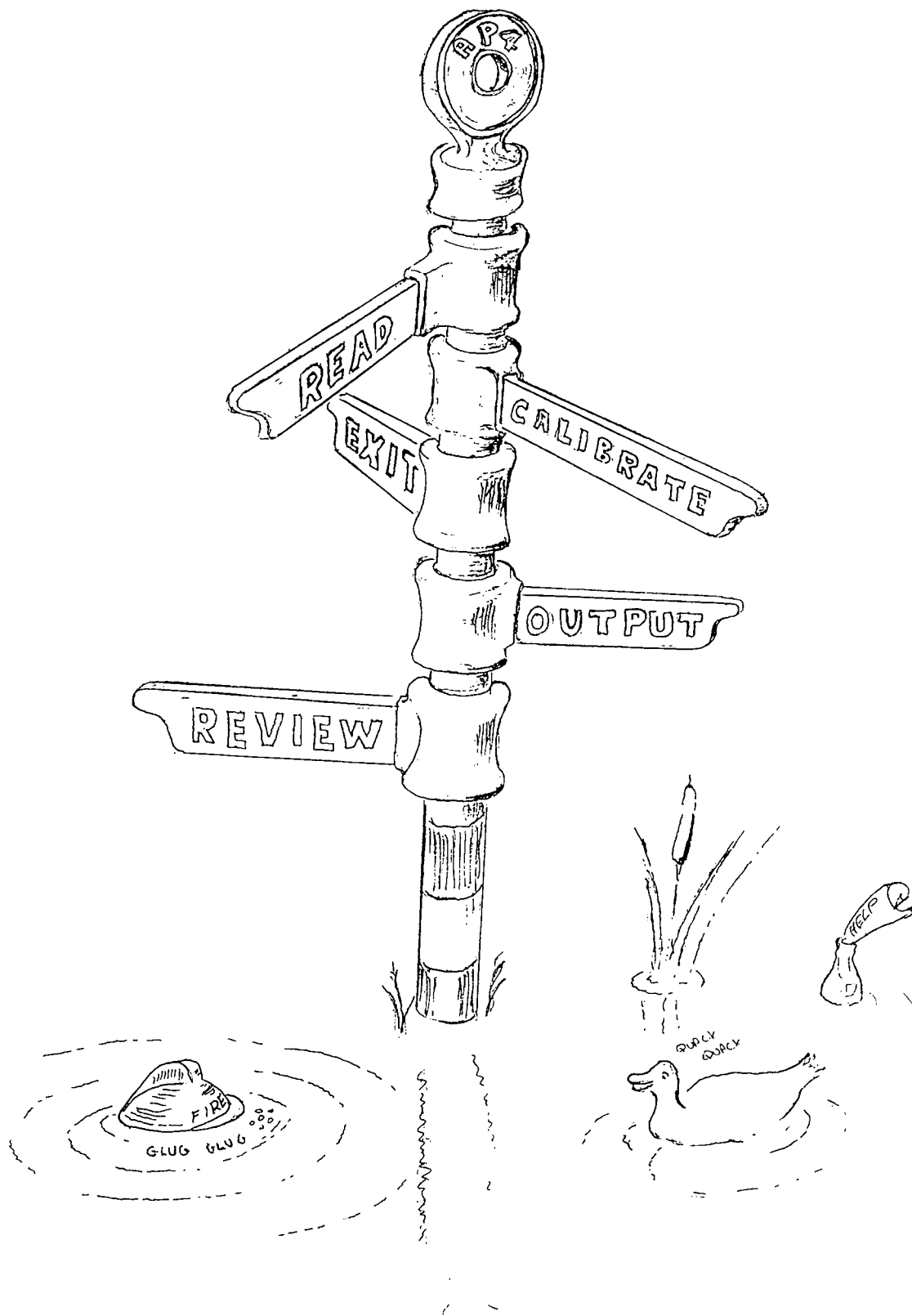

5.4 MENU NAVIGATION

INTRODUCTION

The porometer is controlled by software via the command keys. Control is exerted by selecting between options in menus. These options indicate courses of action. Sometimes you are given more than one choice :- eg READ, CALIBRATE, REVIEW, or OUTPUT. Some places only give one choice, eg START.

The map of all possible courses of action is shown in the beginners' map on page 24.

Use this to find your way around.

Behind most of the "action" screens is a "settings" screen. It's where you go to check or change most default settings and options. A composite map including these is shown in the advanced map on page 25. It is also on the laminated plastic Quick Reference Guide.

A table of settings options summarises what you can change.

CONTENTS

- Beginners' map
- Advanced users' map
- Settings options

MENU NAVIGATION : BEGINNERS MAP

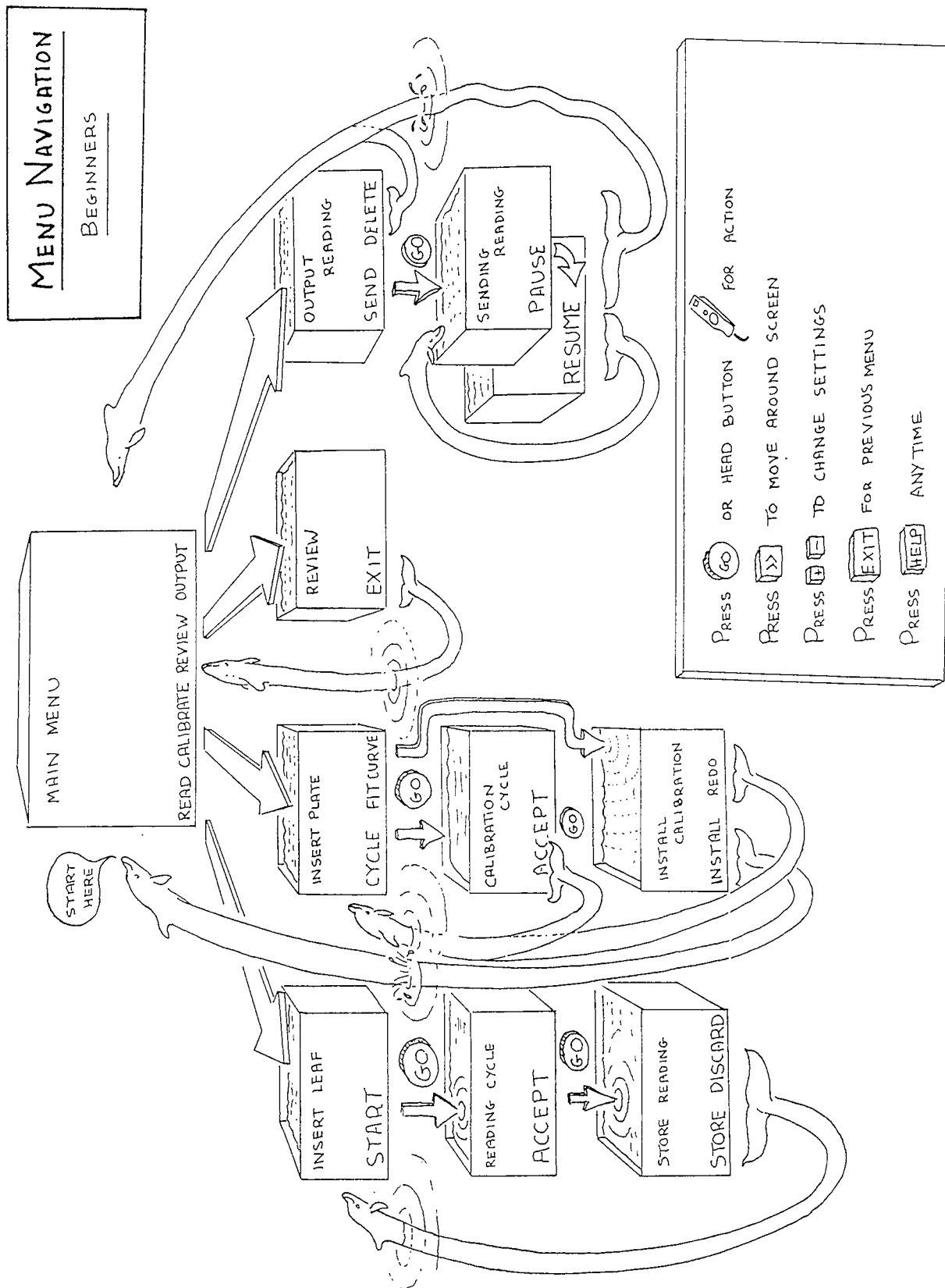

SETTINGS OPTIONS

PATH	ITEM	OPTIONS
MAIN MENU/SET " " " " " " " " "	Date Date format Time Time Format	DAY 1-31 MONTH 1-12 YEAR 0-99 <i>month/day/yr</i> or <i>day/month/year</i> 0-24:0-60 <i>12 hour</i> <i>24 hour</i>
READ/INSERT LEAF " " " " " " " " "	Set RH Leaf Plant Group	5 - 80 1 - 255 1 - 255 0 - 16 characters
READ/INSERT LEAF/SET " " " " " " " "	Output title "Plant" name "Leaf" name	0 - 16 characters 0 - 5 characters 0 - 5 characters
READ/READINGS CYCLE/SET and also CALIBRATE/ CALIBRATION CYCLE/SET	Beeping	<i>On/Off</i>
READ/READINGS CYCLE/SET and also CALIBRATE/ INSERT PLATE/SET " " " "	Units Pressure	<i>cm s⁻¹</i> <i>mm s⁻¹</i> <i>m² s mol⁻¹</i> <i>s cm⁻¹</i> <i>s m⁻¹</i> <i>mmol m⁻² s⁻¹</i> <i>600 to 1200 hPa (mbar)</i>
CALIBRATE/INSERT PLATE " " " "	Position Set RH	1 - 6 5 - 80
CALIBRATE/INSERT PLATE/SET " " " " " " " "	Cup type Order Units & Pressure	<i>slotted or circular</i> <i>1 to 6 or 6 to 1</i> <i>as above</i>
OUTPUT/OUTPUT READINGS	From group	1 - 255
OUTPUT/OUTPUT READINGS/SET " " " " " " " " " " " " " " " "	send as Parity Data bits Stop bits Handshake	<i>CSV or text</i> <i>odd, even or none</i> <i>8, 7</i> <i>1, 2.</i> <i>hardware or none</i>
SHIFT KEY & OFF together, use when installing head	Light sensor Thermistor	<i>0.00 to 9.99 (0.45 typical)</i> For setting zero offset

6. HOW TO TAKE READINGS

This section explains how to take readings, how to calibrate, and how to review, output and print results.

CONTENTS

■ Preparation	6.1
■ A typical measurement session	6.2
■ How to READ ie measure a leaf	6.3
■ How to CALIBRATE the porometer	6.4
■ How to REVIEW the data	6.5
■ How to OUTPUT to a printer or computer	6.6

6.1 PREPARATION

Beginners : Skip this section (6.1). Get out there, take some readings and enjoy yourselves.

Before running an experiment you should know what a porometer is, what it is used for, and why you are using it. If not, do a small pilot project. Get and process some data before doing a big project.

Before taking readings, run through the following :-

Check the warnings : Chapter 2.

Check that you have everything you need : Chapter 3.

Are you familiar with the controls? : read Chapter 5 and play with them.

Check the desiccant, battery and memory : Chapter 7.

Have you planned your experiment? : Chapter 7.

Are you an expert? : Chapter 8.

Do you know roughly how it works? : Chapter 11.

6.2 A TYPICAL MEASUREMENT SESSION

Press **ON** Check memory,
battery, and desiccant.

Press **SET** to reset clock & calendar,
& to change format.

Select **CALIBRATE**
Measure ambient %RH.
Prepare calibration plate.
Insert calibration plate at 1st position.
Take reading. Is it OK?
If OK, accept it and measure next position.
Do all 6 positions.
Install calibration data.

Select **READ**
Put leaf in head.

Select **START**
The AP4 starts taking readings.

ACCEPT the reading.
The AP4 stops taking readings.

STORE or **DISCARD**
Choose one of these options.

Repeat the measurement or go on to the next leaf .

EXIT to return to the main menu.

You can then **REVIEW** the data.

Finally, data can be **OUTPUT** to a computer or printer.

6.3 HOW TO READ

This section describes how to take readings by driving the porometer around the READ loop, and what settings can be changed.

- Warnings
- The reading loop
- Changing the settings
- Insert leaf
- Reading cycle
- Store readings

WARNINGS

Keep cup relative humidity (RH) below 80% if possible.

Avoid exposing the cup to organic solvents and smoke.

Keep calibration plate clean, avoid finger grease.

Remove excess water from paper pad before taping it to the calibration plate.

Recalibrate whenever the temperature changes by more than 5°C.

Recalibrate when changing RH set point.

Do not allow battery to remain discharged.

Prepare and plan your experiments : see Chapters 7 & 8.

See also :

To recharge battery :	see Chapter	10.1
To free memory :	" "	6.6
To renew desiccant :	" "	10.4
To trouble shoot :	" "	10.12

THE READING LOOP

Readings can be taken one handed. Just press the GO button on the head.

YOUR ACTION	POROMETER ACTION	DISPLAY TITLE
Press ON	Porometer wakes up	MAIN MENU
Press GO	Selects READ loop	INSERT LEAF
Insert leaf	Waits	" "
Press GO wait	Selects START option Starts cycling	READING CYCLE updated with every reading
Wait 4 or 5 cycles until readings are steady or until double beep		
Press GO	Stops cycling and ACCEPTS last reading	STORE READING
Press GO	STORES last reading Loops back to beginning of READ cycle	returns to INSERT LEAF display

Congratulations on taking your first reading!

CHANGING THE SETTINGS

You are now able to take readings, but there are checks and settings to think about if you want to be accurate. You also have optional choices, such as what units you want the results displayed in and what titles to use for groups of data. Setting the communications protocol with the printer or computer is a choice you *must* get right.

Up to now you have just used what we might call "action" screen displays. They always have at least one option displayed on the bottom line, representing an action activated by the GO button.

Some of the action screens have information displayed in inverse video. This can be changed using the + and - keys. Most action screens have a settings screen behind them. You can bring them forwards with the SET button. This is where you go to change most of the settings.

Use the >> key to highlight each option in turn, and change them with the + and - keys in the normal way. Press HELP if you get stuck.

Opposite you can see a navigation map for the read cycle. See also the laminated plastic Quick Guide for a complete map.

Figure Press GO to navigate around the reading loop

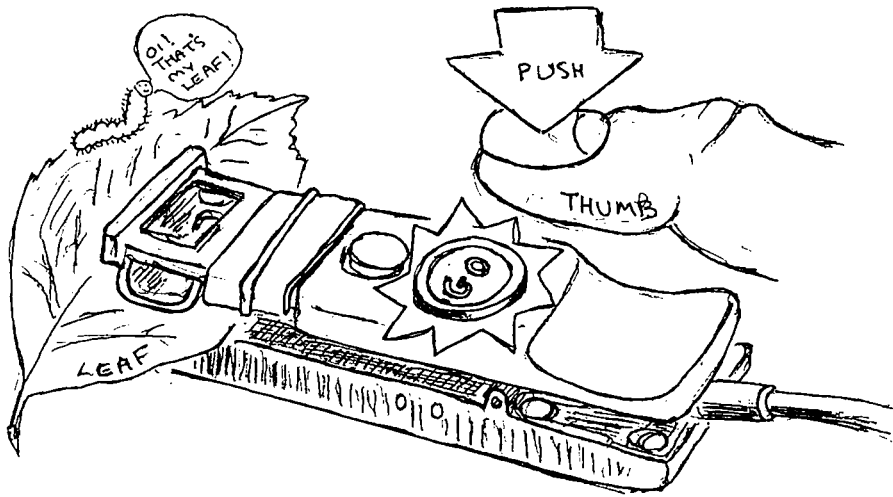
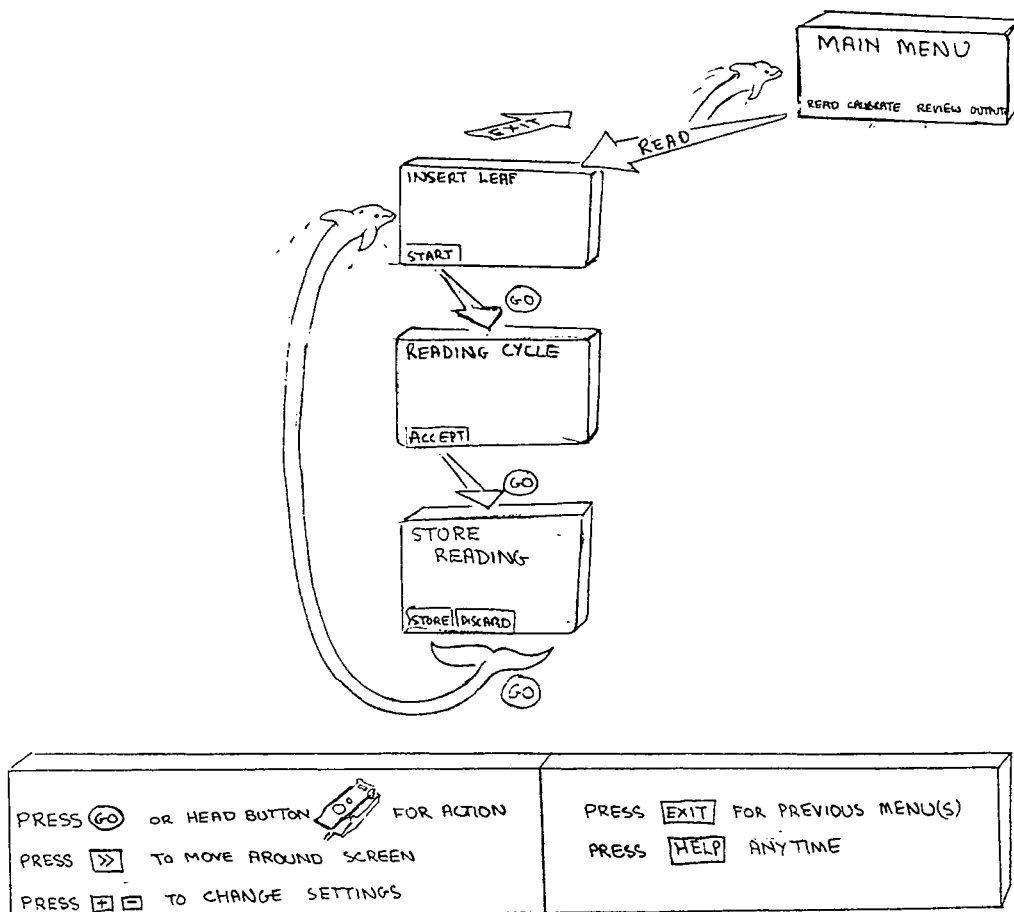

Figure ... Navigating the READ loop



INSERT LEAF SCREEN DISPLAY

The left hand box on the display refers to what has changed since the AP4 was last recalibrated. When one or more of the items flash it is time to recalibrate.

"RH :" shows the difference between the current set point and that used at the last calibration. (RH stands for relative humidity, the porometer cycles around the set point). The reading is displayed in inverse, denoting that this setting can be altered.

"Temp:" refers to the change in cup temperature since the last calibration. The AP4 automatically corrects for changes in temperature. When the difference is too big the porometer will keep on doing its best for you, but the display will flash a warning.

Open the head and wave it about to equilibrate. The "Head RH" reading indicates the ambient RH. Using this, change the RH "Set" value in the right hand box. Use the + and - keys to do this until close to ambient. This will cause the least disturbance to the stomata, and minimise any errors due to leakage between the cup seal and leaf. If the pump comes on, press + or -. This disables the pump until you press GO.

Recalibrate when you change the RH Set point.

You may alter the **leaf** and **plant** number if you wish. This will never cause you to lose data. The AP4 will automatically increment the leaf number if you do nothing.

The AP4 stores readings in **groups** which you can name via the keyboard. Each group is also given a number which you cannot alter. Example group names : Treatment, Control.

The AP4 will create a new group number whenever you change one or more of the following : '*group*' name, '*plant*' name or '*leaf*' name and also *units* or *RH Set*.

READINGS SETTINGS SCREEN DISPLAY

Press SET to access this.

If you wish you can change the names of the labels used to identify groups and subgroups of readings here. Their use can be appreciated by studying the sample printout of data, see the sample printout at the back of Chapter 6.6

To begin with, do add an output title, but do not change the name "plant" or "leaf".

Later you might want to change these labels to match the way your samples are organised. Any name of up to 5 characters long is OK. Each reading is given a unique number by the porometer anyway, and also you can add a short note after each reading. Do not worry. It will become clear later.

INSERT LEAF

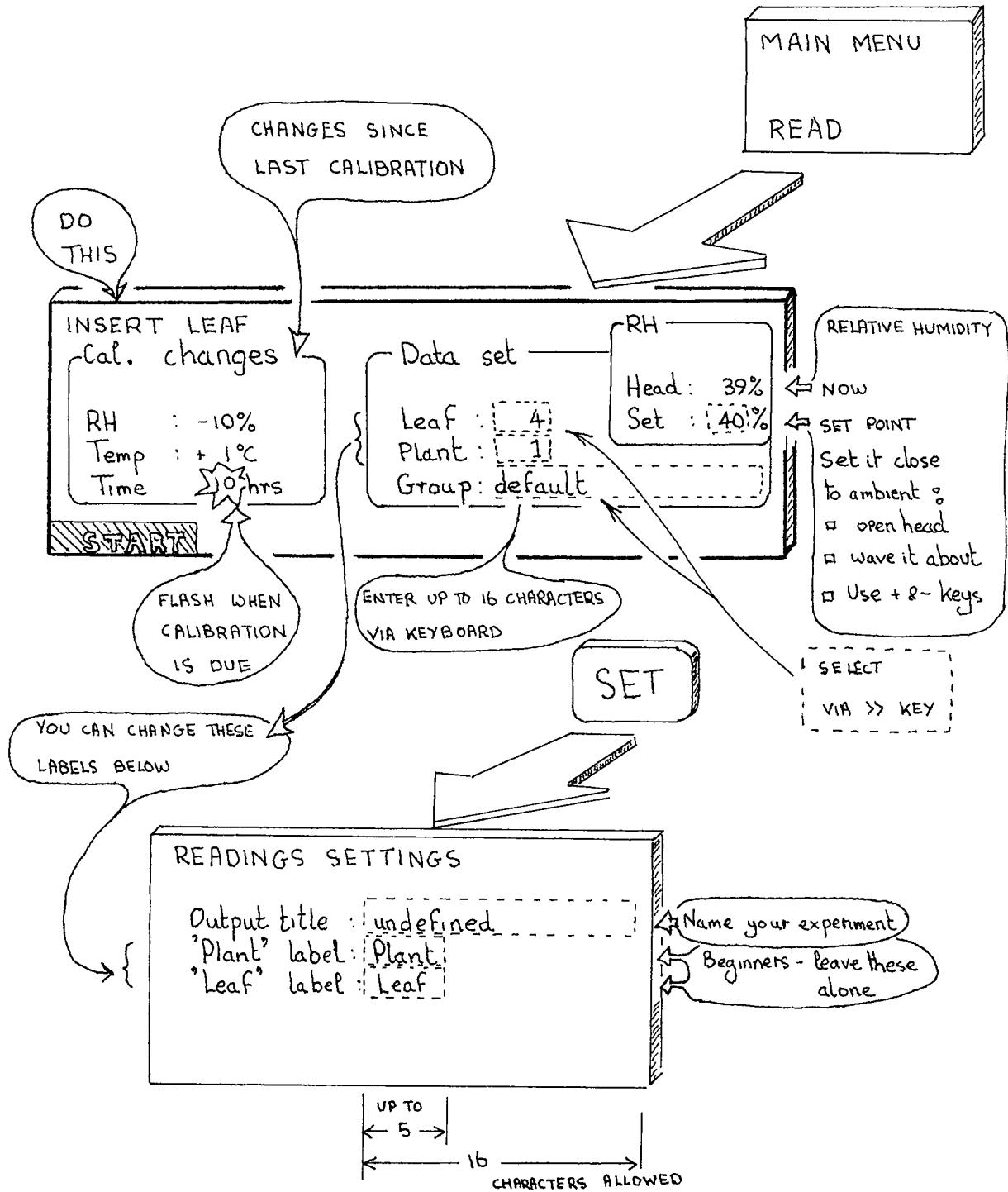

TYPICAL PRINT OUT

TITLE: PF trials		Printed: 9/11/90 2:41 pm					
GROUP: beet - plot 5	Date : 9/11/90	Set RH: 50%	Units: s/cm Press: 1000 hPa				
Time	Plant	Leaf	Resist.	Cup T	Cup-Leaf	Light	Notes
2:00 pm	1	1	2.00	12.6	1.2	15	looks pretty rough
2:01 pm	1	2	2.98	12.2	1.1	45	windy again
2:02 pm	1	3	2.80	11.8	0.7	40	

READING CYCLE

Readings are displayed on the left. A bar graph shows the percentage RH in the cup. A tick mark below the scale indicates the set point.

Inside the box on the right the cup temperature, leaf-cup temperature difference - δT , and the RH are displayed.

Try to keep $\delta T < 1^\circ\text{C}$ if possible by allowing the leaf and cup to thermally equilibrate. Wait for the reading to stabilise. The accuracy of results also depends on any changes in the cup temperature since it was last calibrated, so recalibrate frequently.

Automatic temperature correction is incorporated in this version (2) of the software. See also : *How the Results are Calculated*, chapter 11.2

See *Hints and Tips*, Chapter 8, for our collective wisdom on good experimental technique.

CYCLE SETTINGS SCREEN DISPLAY

Beeping : ON/OFF

This refers to a small loudspeaker. When ON, it goes "Beep-beep" if two consecutive readings are within 2%. Combined with the use of the GO button on the porometer head this allows you to take and store readings without needing to look at the screen at all.

<u>Units</u> :	s m ⁻¹	}	resistance
	s cm ⁻¹		
	m ² s mol ⁻¹	}	conductance
	mm s ⁻¹		
	cm s ⁻¹		
	mmol m ⁻² s ⁻¹		

For an explanation of these units see Chapter 8.2

Pressure : hPa (mbar)

If you have a barometer, enter the actual pressure. If you do not, do not be alarmed. Put in the standard pressure at your altitude above sea level. Use 1000 hPa (mbar) at sea level. Reduce this by 100 hPa for every 1000 m. The results will be referenced to the pressure you have entered. Recalibrate if you change altitude by 1000 m or more, or if there is an extreme change of weather.

See also Chapter 8.3

READINGS CYCLE SCREENS

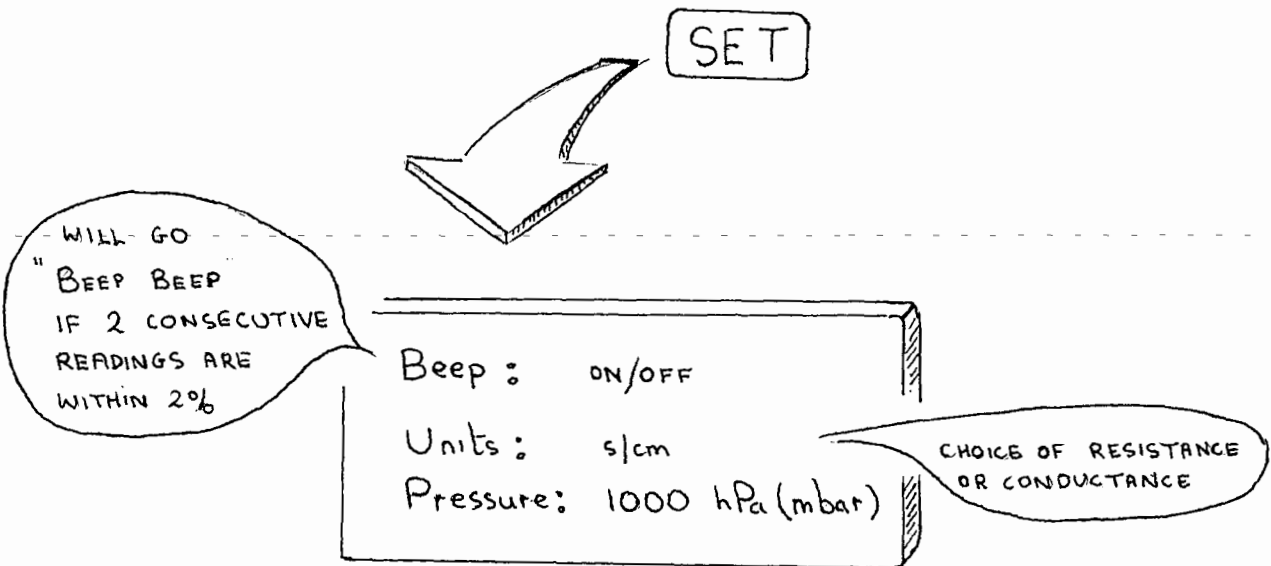
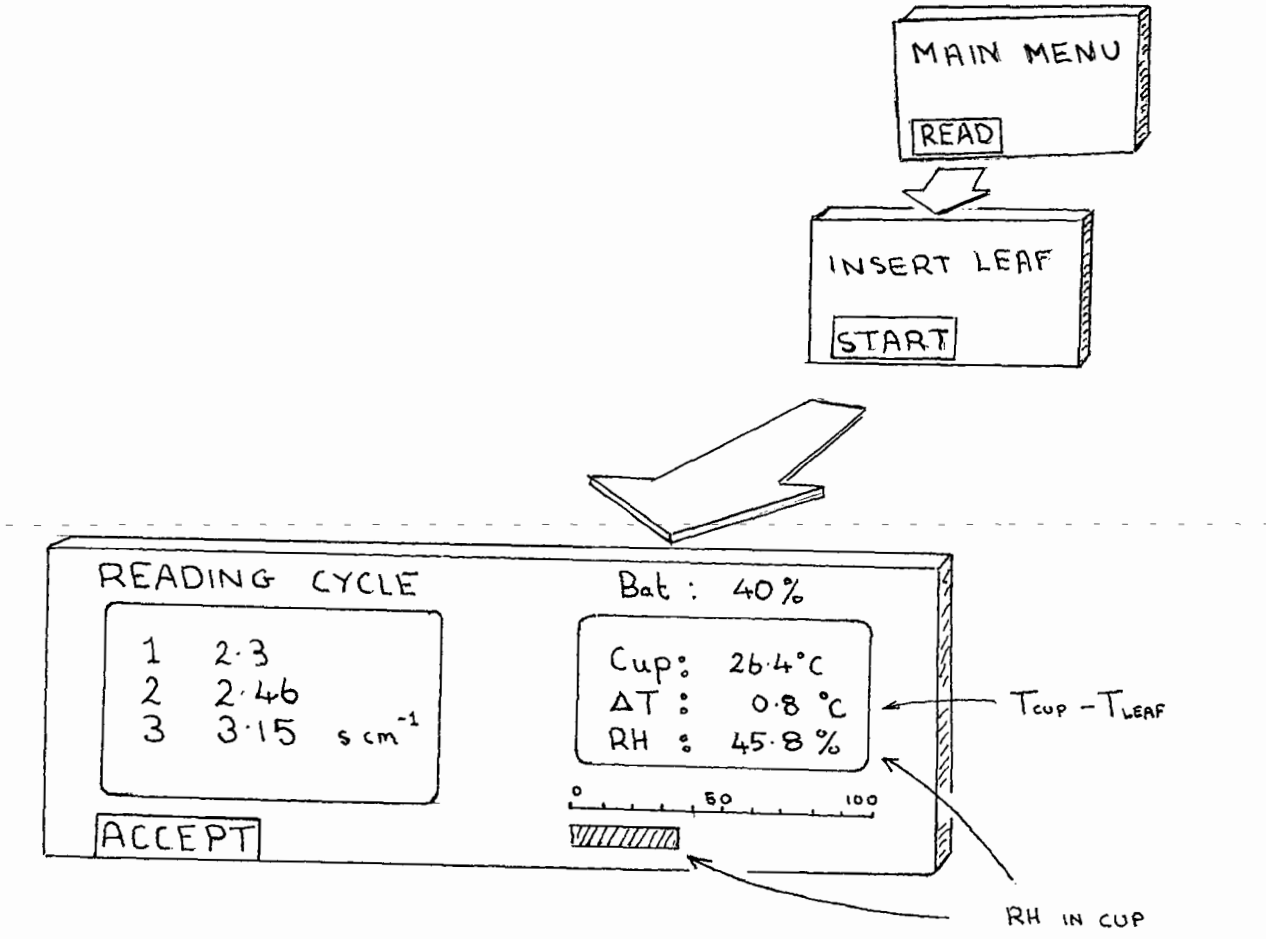

STORE READINGS

The box shows what information will be saved with the reading.

Add a note of up to 30 characters to each reading if you wish. This costs you memory, but there is lots of it. Do not worry unless someone has been using the instrument and left lots of readings in it.

See also : "How many readings to take" and "Memory usage" in Chapter 7.

Notice that the light sensor reading changes if you change the lighting. The only value which will be saved is the one existing at the instant when you press GO to select STORE. So position the head thoughtfully when you do this.

STORE SETTINGS SCREEN

The leaf number automatically increments by 1 every time you store a reading. You can also change it manually if you wish, with the + and - keys, in the normal way.

Increment the plant number with the + button when you change to another plant.

If you want to you can label your plants with these numbers.

Actually you can label and read your plants in any order you like. Your AP4 just prints the number along with the rest of the data for that leaf. You do not have to start at number 1.

Advanced Users

Provision has been made for you to change the name "plant" and "leaf" on the set screen called "Readings Settings" at the beginning of the READ loop. You may use the word "plot" or some other.

STORE READINGS SCREENS

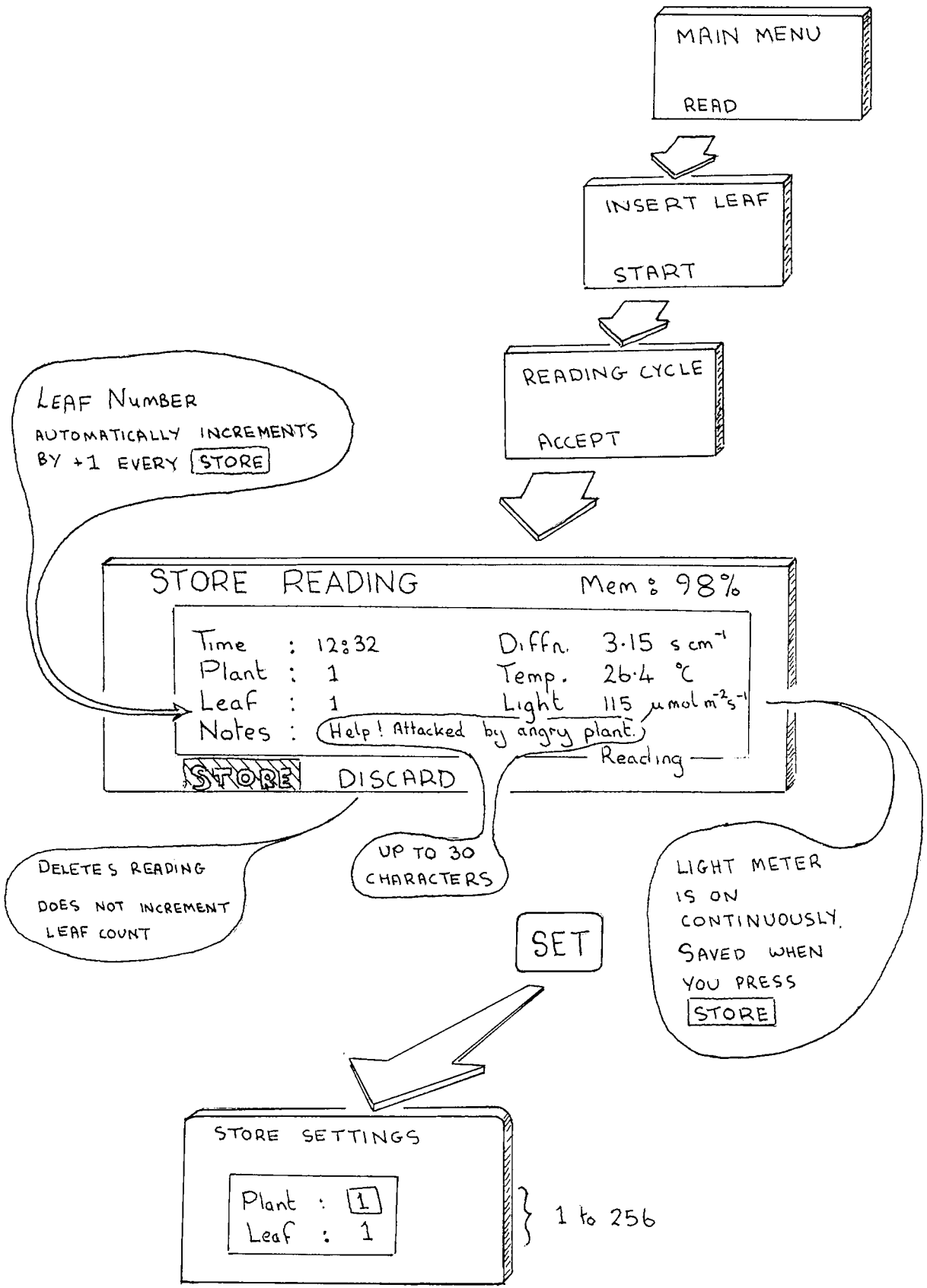

THE CALIBRATION LOOP

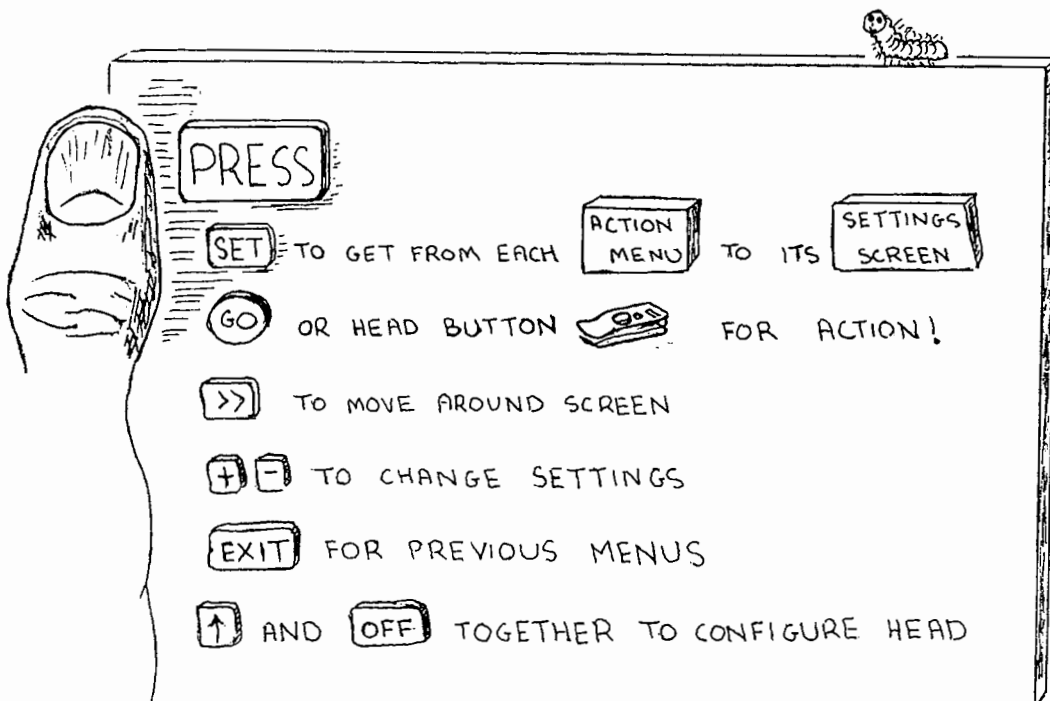
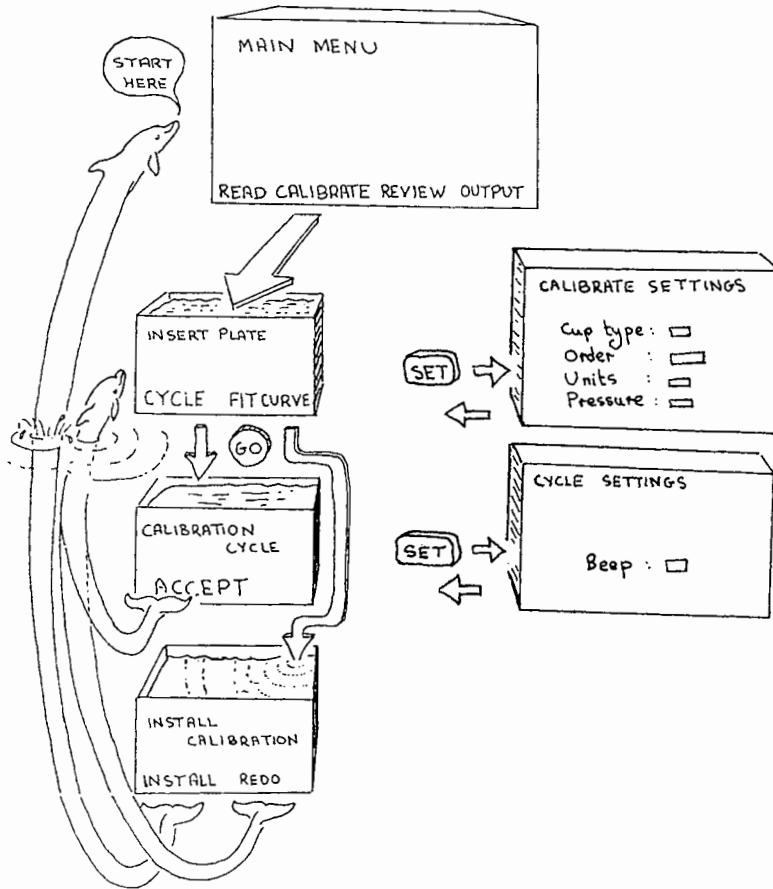

6.4 CALIBRATION

This section covers how to calibrate the porometer using the calibration plate.

- Preparation
- The calibration loop
- Insert plate
- Calibration cycle
- Insert plate (subsequent plate positions)
- Install calibration
- Summary

PREPARATION

You need a Calibration Kit comprising of :-

Calibration Plate in plastic envelope
Pack of filter pads
Tape

You also need :-

Scissors
Distilled water - 250 ml should be more than adequate
(only a small amount is needed
to wet a filter pad \approx 5 ml)
Tissue paper or blotting paper

You may wish to use a barometer, such as the wristwatch-style one which we can supply as an accessory. Without it a 100 hPa (mbar) pressure change, or a 1000 m change in altitude will cause a 10 % error in measured resistance. If the pressure does not change significantly between calibration and measurement, then you can get away without a barometer. See also page 34, and Chapters 8.2 & 8.3 for a discussion of how much and when it matters.



WETTING THE FILTER PAD

Wet the paper all over with distilled water.

Remove the excess water with blotting paper or absorbent tissue paper.

Repeat two more times with fresh dry absorbent paper.

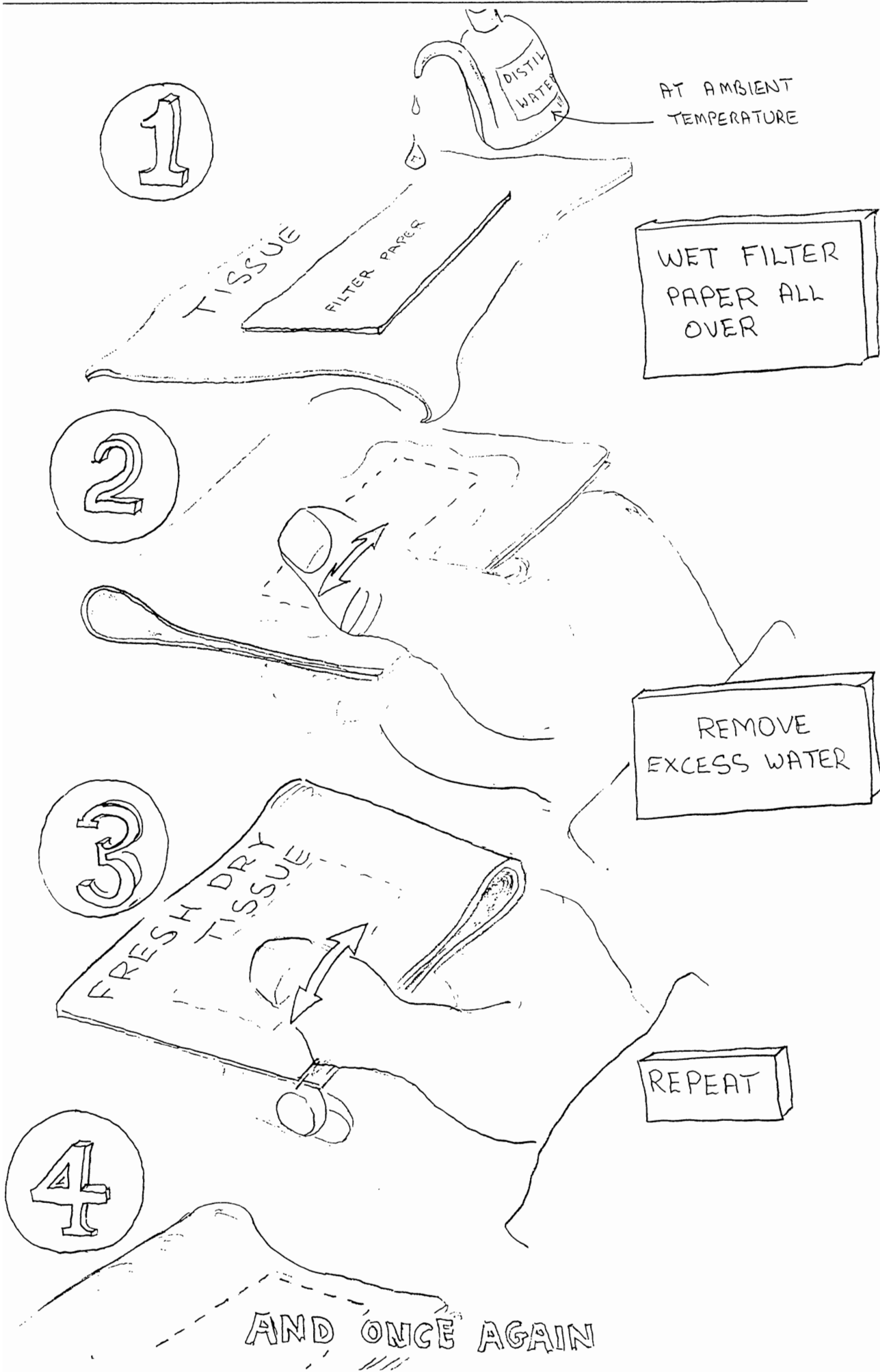

STICK DOWN THE PAD

Place the damp filter paper on the back of the calibration plate to cover all the calibration holes.

Seal down with sticky tape.

Trim loose tape from the edges.

Smooth down the tape to remove any air pockets.

Return the calibration plate to its plastic zipper-lock bag until needed. This will slow down the rate at which it dries out, and also keeps it clean. In our experience, in the U.K., it has stayed damp for three days if kept in its bag.

Protect the plate from greasy fingers!

Leave for about 1 hour before calibrating.

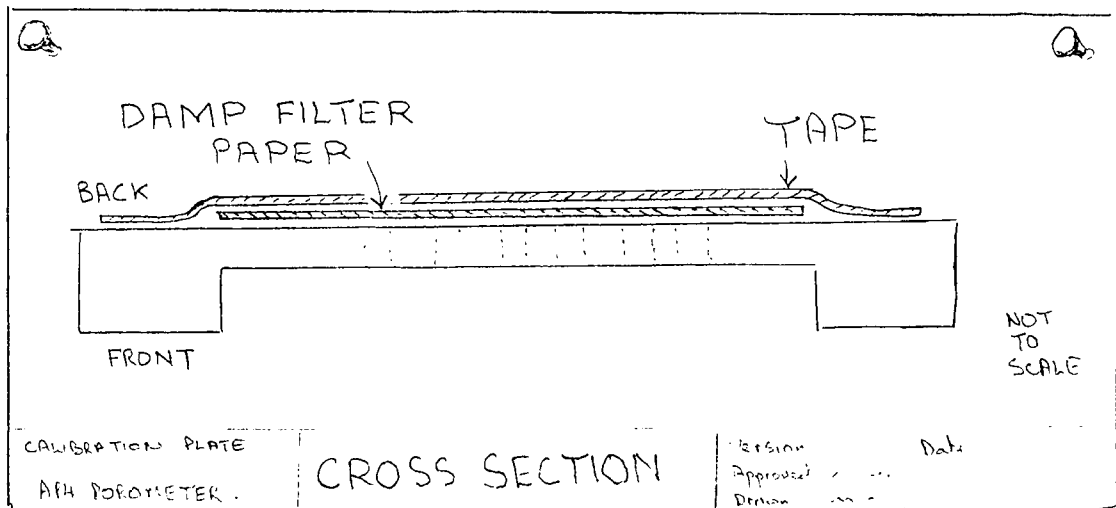
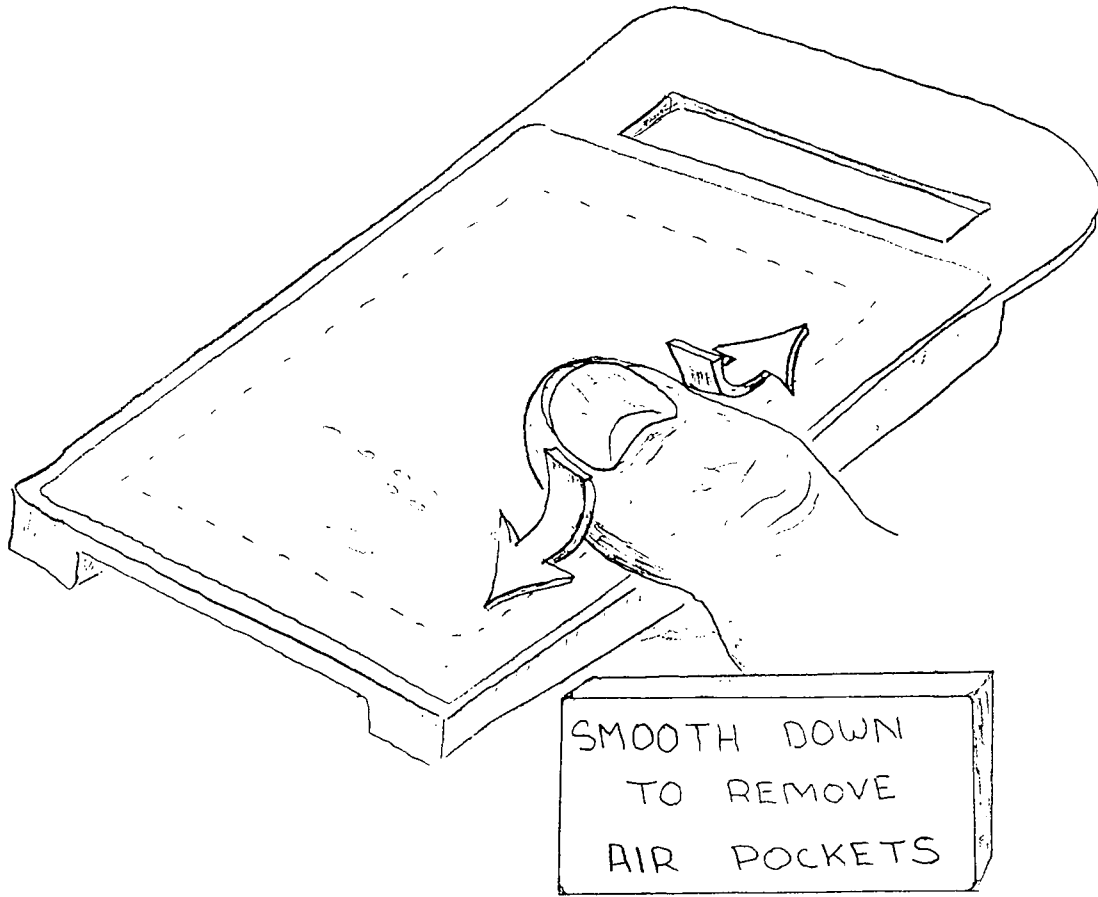

CALIBRATION LOOP

Calibration is similar to taking readings in that there are three stages, Insert Plate, Calibration cycle and Install. The program automatically keeps track of where you are. It will lead you through the measurement of all six positions on the calibration plate before asking you whether to install the new calibration.

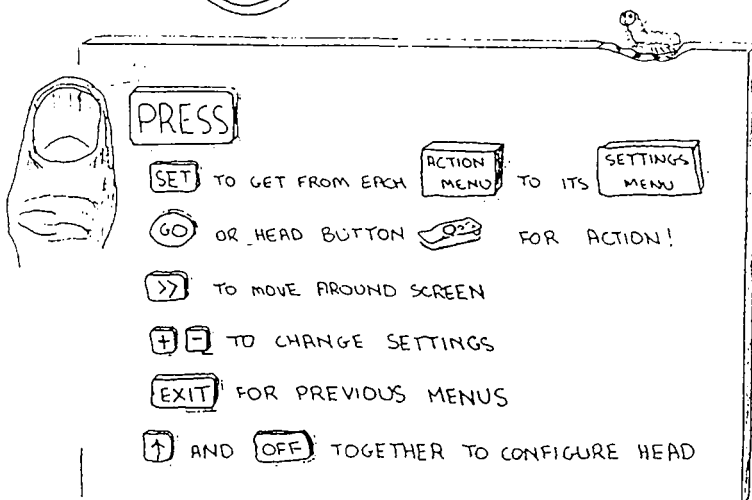
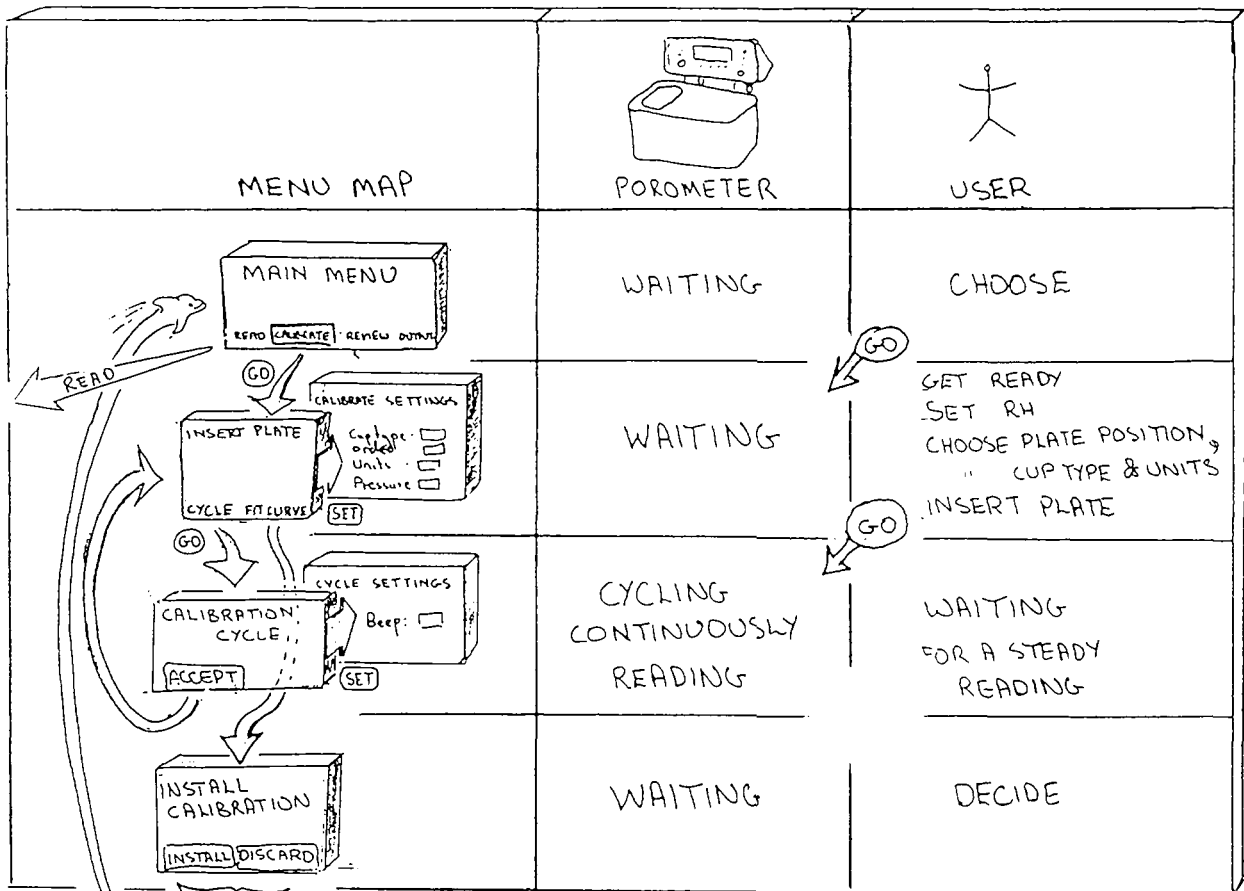

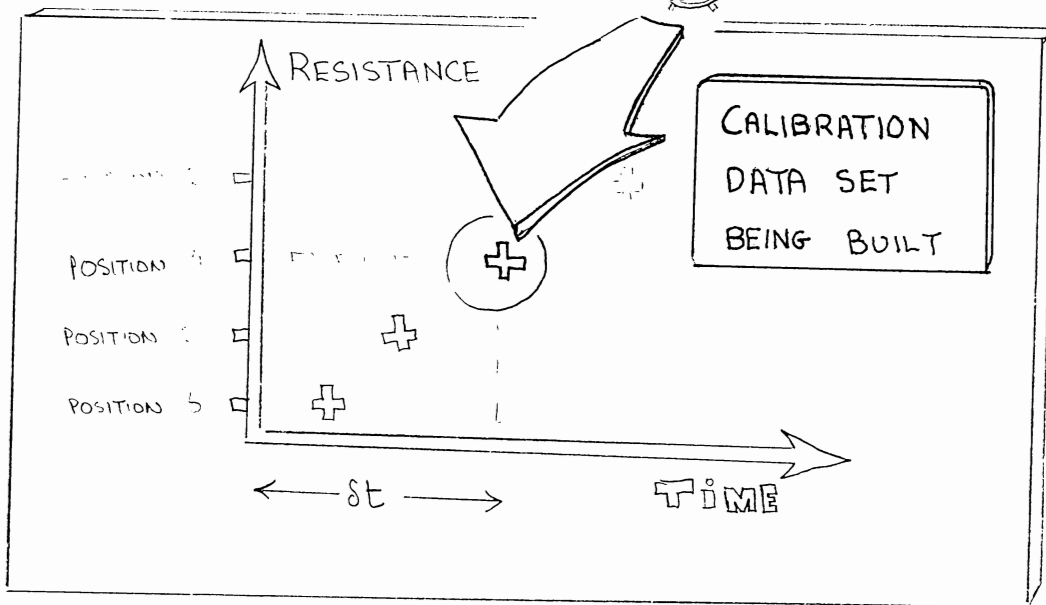
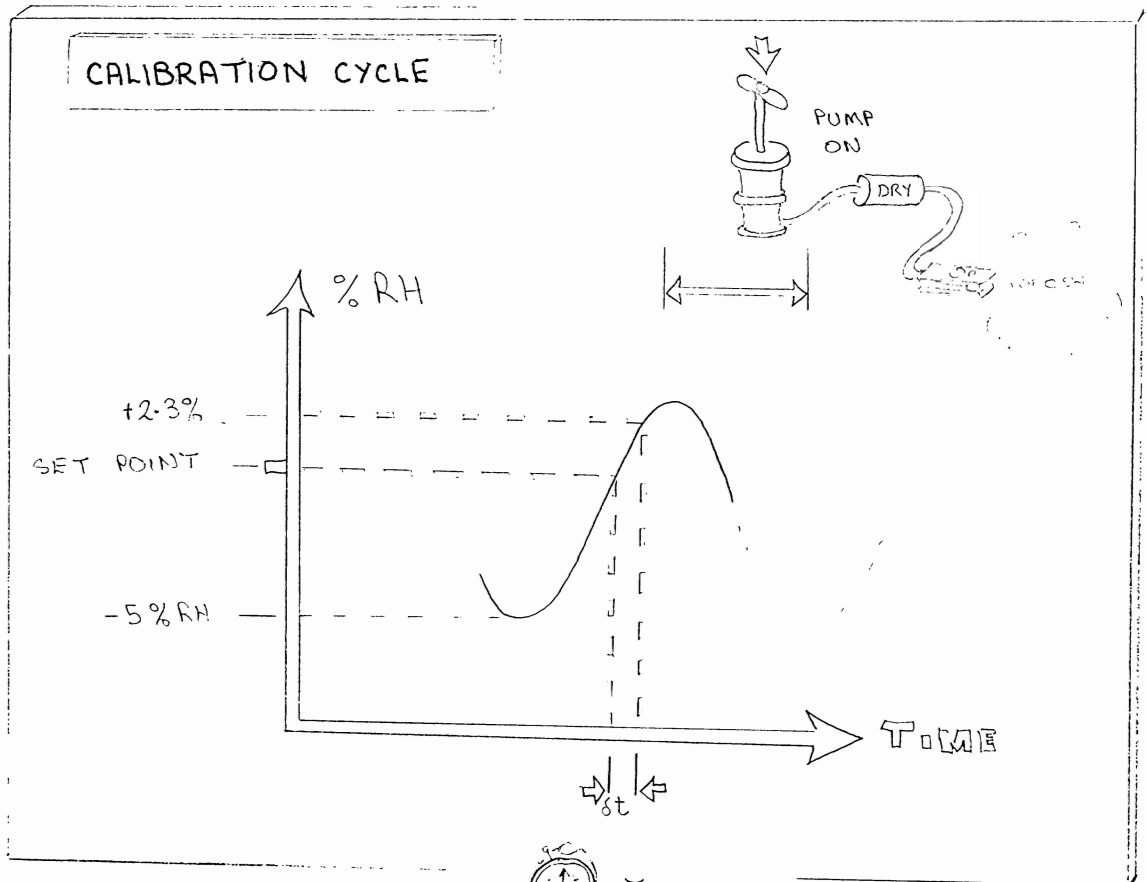

INSERT PLATE

This is the title of the first action screen display which appears when you select CALIBRATION from the main menu.

The right hand column shows the calibration plate's true (theoretical) values adjusted to the current cup temperature and the default or set atmospheric pressure. Next to it is an empty column for readings.

Position : 1 indicates that the calibration plate should be positioned so that first row of holes is measured. The row numbers are moulded on the sides of the plate. Ensure that the plate is sitting snugly against the cup seal. The position indicated can be changed with the + or - key, but you do not need to do this unless you want to repeat a reading.

RH Head : indicates the actual relative humidity in the cup.

RH Set : indicates the fixed value that the porometer will cycle about.

What to do

Select **Set RH** and press + or - to temporarily disable the pump. Open the head and wave it about.

Read the **Head RH** to determine the ambient RH.

Adjust the **Set RH** value with the + or - key to be close to ambient.

Press SET to call up and change any of the default values on the settings screen (see below).

Press GO or EXIT to return to the INSERT PLATE screen.

Insert the plate at the position indicated.

Press GO to START cycling and reading.

See Chapter 8 for hints and tips on good experimental technique.

CALIBRATE SETTINGS

Cup type : Slotted or circular cups can be chosen.
See also 10.6

Order : You can choose whether to go from calibration plate position 1 to 6 or from 6 to 1

Units :

$s\ m^{-1}$	}	resistance
$s\ cm^{-1}$		
$m^2s\ mol^{-1}$		
$mm\ s^{-1}$	}	conductance
$cm\ s^{-1}$		
$mmol\ m^{-2}s^{-1}$		

Results can either be given in units of resistance, or its reciprocal, conductance. See Tutorial in Chapter 8.2

Pressure: See page 34 and Chapter 8.3

INSERT PLATE

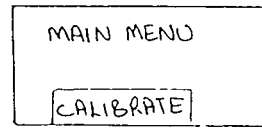
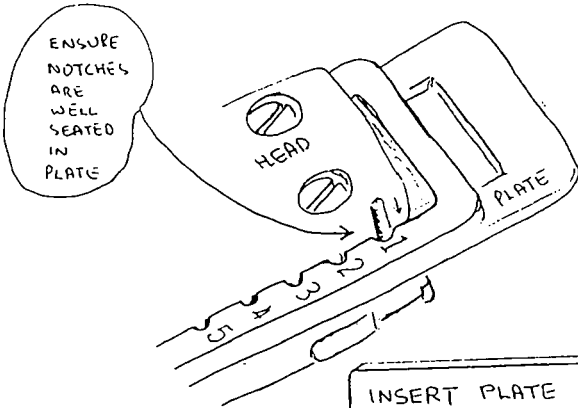

INSERT PLATE

Position: 1

Head RH: 43%

Set RH: 45%

#	READING	PLATE
1	...	24.8
2	...	15.0
3	...	6.75
4	...	2.89
5	...	1.54
6	...	0.17

START

Calibration plate known (true) values at current cup temperature T_c (and atmospheric pressure setting).

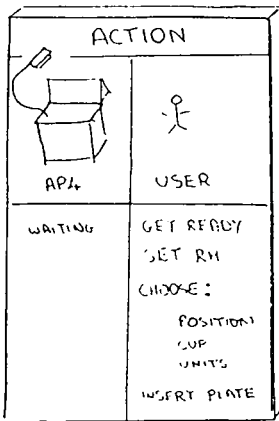

SET

CALIBRATE SETTINGS

Cup type: slotted circular

Order: 1>2>3>4>5>6

Units: scm^{-1}

Pressure: 1000 hPa (mbar)

RESISTANCE OR CONDUCTANCE?
MOLAR UNITS OR NOT?

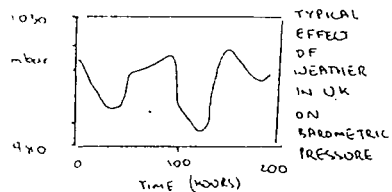
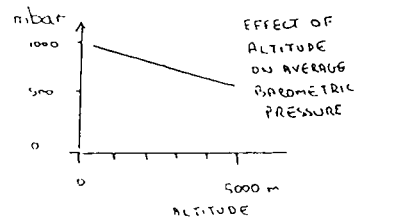
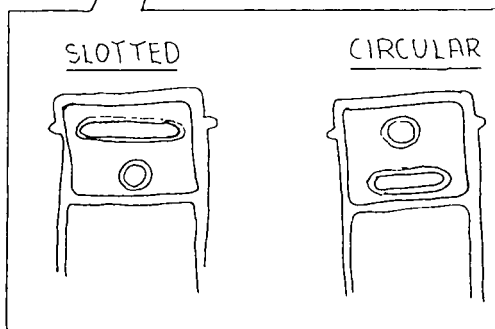

CALIBRATION CYCLE

The porometer is automatically cycling and taking measurements of the transit time. This is the time it takes the calibration plate to release enough moisture to raise the cup RH by a fixed amount. Dry air is then pumped through the chamber until the RH is a few percent below the set point. The cycle repeats until you press GO to ACCEPT the last reading.

CYCLE SETTINGS

Beeping : ON or OFF

This refers to a small loudspeaker. When ON, it goes "Beep-beep" if two consecutive readings are within 2%.

CALIBRATION CYCLE

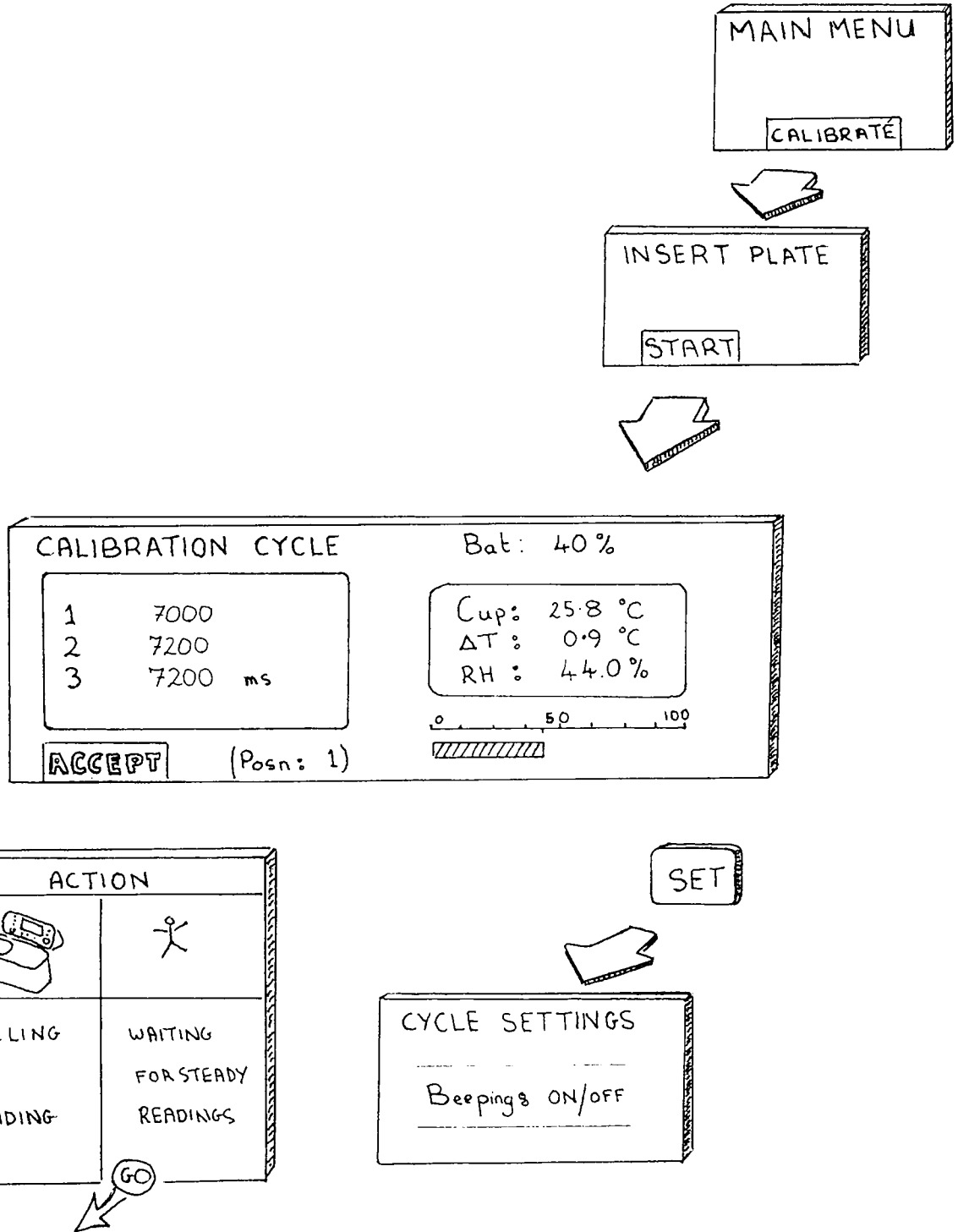

INSERT PLATE (for subsequent plate positions)

After choosing ACCEPT in the first calibration cycle run you automatically return to the INSERT PLATE screen. The reading you have just accepted is displayed in the results column. It will have been automatically converted from time to resistance or conductance units.

You may also notice the corresponding true calibration plate value updated in the right hand column. It displays the theoretical value true at the cup temperature at which the reading was taken.

The left-hand, results column, is a *measured* value based on the previous calibration. This may have been done some time ago - which may be the reason you are recalibrating. Do not worry about the logic of this right now, it will get sorted out as we go along.

It does not matter, at this stage, if these two readings are wildly different. Wait until you have worked through, or at least attempted to work through, all 6 plate positions, and then accepted the curve-fit option (which will appear later). After that the results will be recalculated using the current measured transit times and theoretical plate values as data. The two sets of readings should then match quite closely. Wait until then before deciding whether you need to redo any calibration reading.

So for now, re-insert the calibration plate, at the next position, and retake the reading as before.

Repeat this until all six positions are done.

After four consecutive positions the **FIT CURVE** will appear. Ignore this option until you have done all 6 positions, then accept it. Beginners should always go for all 6 readings. Only accept less if you are forced by circumstances - for instance if a reading is far too slow. The experts may curve-fit on less than six positions in special situations. This is discussed in greater detail in the advanced tutorial in chapter 8.

Move to next plate position

Last reading at last plate position calculated at T_{cup} , P_{set} (atmospheric pressure set) & adjusted to $\delta T = 0$

INSERT PLATE :	#	READING <small>s cm⁻¹</small>	PLATE
Position 2	1	25.7	24.2
	2		15.0
	3		6.75
	4		2.89
	5		1.54
CYCLE	6		0.77

Updated to latest cup temperature (T_{cup})

Next position : You can change this. But always try to do all 6 positions first before going back to redo a reading

↓
Loops back to cycle at next plate position

LOOP
3
4
5

This column always has measured values

This column always has known (ie theoretical) values

INSERT PLATE :	#	READING <small>s cm⁻¹</small>	PLATE
Position 5	1	25.7	24.2
	2	15.0	15.1
	3	8.5	6.8
	4	3.85	2.92
	5	1.54
CYCLE	6	0.77

↑
Appears after 4 positions done. But repeat CYCLE for all 6 positions (except for special situations) Then select FIT CURVE to calculate the new calibration parameters

← Last position done
← Not done yet
← Keep going!

INSTALL CALIBRATION

After you select FIT CURVE the AP4 accepts the last reading at the last plate position, and with the readings from all the other positions, it calculates the new calibration constants for the cup.

The new calibration is then used to recalculate the measured values in the left-hand results column. Now is the time to compare the measured and true values in the left and right columns. Look for glaring discrepancies which might indicate a possible experimental error on one of the plate positions.

To help you decide whether you like the quality of the new calibration data, the porometer calculates a statistical estimate of the average error over all the readings.

It is defined as follows :

$$\sigma = \left[\frac{\sum_{m=1}^{m=N} \{(r_m - r_t)/r_t\}^2}{N - 3} \right]^{\frac{1}{2}} \times 100 \%$$

where r_t = true or theoretical plate resistance
 r_m = measured plate resistance
 N = number of positions used.

On the porometer screen this is called the curve error. A fuller description is the standard deviation of the residual errors.

This figure is useful when calibrating to check that the calibration ran OK. If the error is 5% then go ahead and INSTALL it. If the error is 10 to 15% then look up and down the results column and redo the worst reading. We quote the porometer to be accurate to $\pm 20\%$ once it is accurately calibrated. So the spread on you readings should be better than this.

If the error is greater than 10 % the cursor will (suggestively) surround the REDO option. Otherwise it will suggest you accept the INSTALL option. When you do this, it saves the new calibration settings.

Things to do if the curve fitting error is unacceptably large :

- Redo calibration on the worst plate position.
- Ensure calibration plate is properly seated against the cup, and protect it from the wind.
- Check the cup seal is OK.
- Check the calibration plate is clean, moist and has had about 1 hour to stabilise since it was last moistened.
- Check for thermistor damage. (Is the δT erratic or greater than $.5^\circ\text{C}$ on the shift-OFF screen when the cup is in thermal equilibrium)

See also the advanced tutorial in chapter 8.

INSTALL CALIBRATION

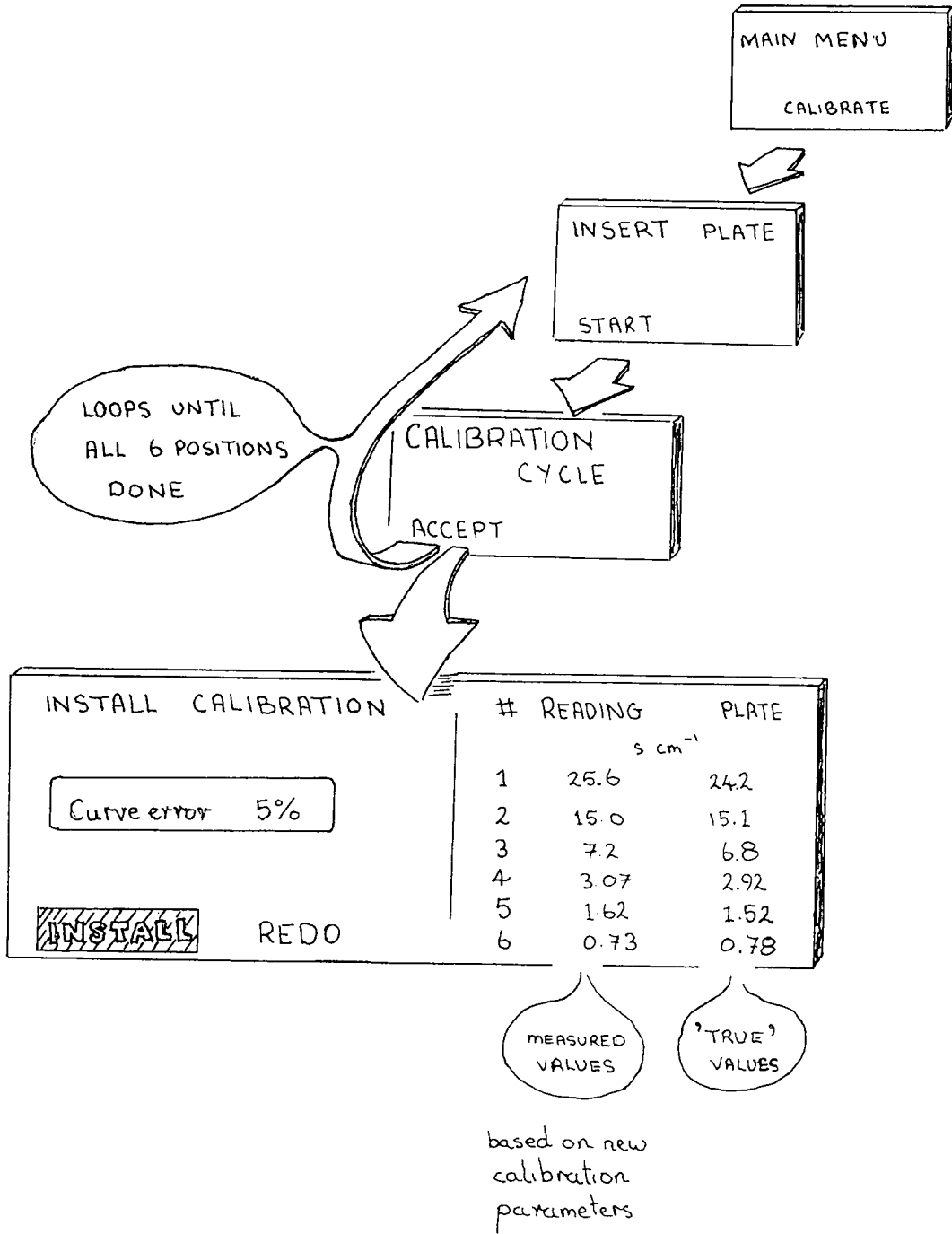

SUMMARY

- Prepare calibration plate ahead of time.
- Leave it to stabilise, in its plastic envelope, for about 1 hour.
- Set RH close to ambient.
- Check other settings:-
 - Cup type : slotted or circular
 - Units : resistance or conductance
 - Pressure : actual barometric pressure
or average barometric pressure at your altitude
or leave it at 1000 hPa (mbar)
- Insert damp calibration plate at position 1.
Ensure it fits snugly.
- Press GO to start the reading
- Wait until readings are stable, then press GO to ACCEPT it.
- Move plate to next position and repeat until all 6 positions are read.
- Select CURVE FIT. The porometer then fits a calibration curve to the data, recalculates the results and estimates the error.
- INSTALL if the error is less than 10%
- Otherwise DISCARD and redo the worst result.

6.5 REVIEW



REVIEW

Select REVIEW from the MAIN MENU.

Use the + and - keys to step through the data.

No editing can be done, and no settings changed within REVIEW.

REVIEW

MAIN MENU

REVIEW

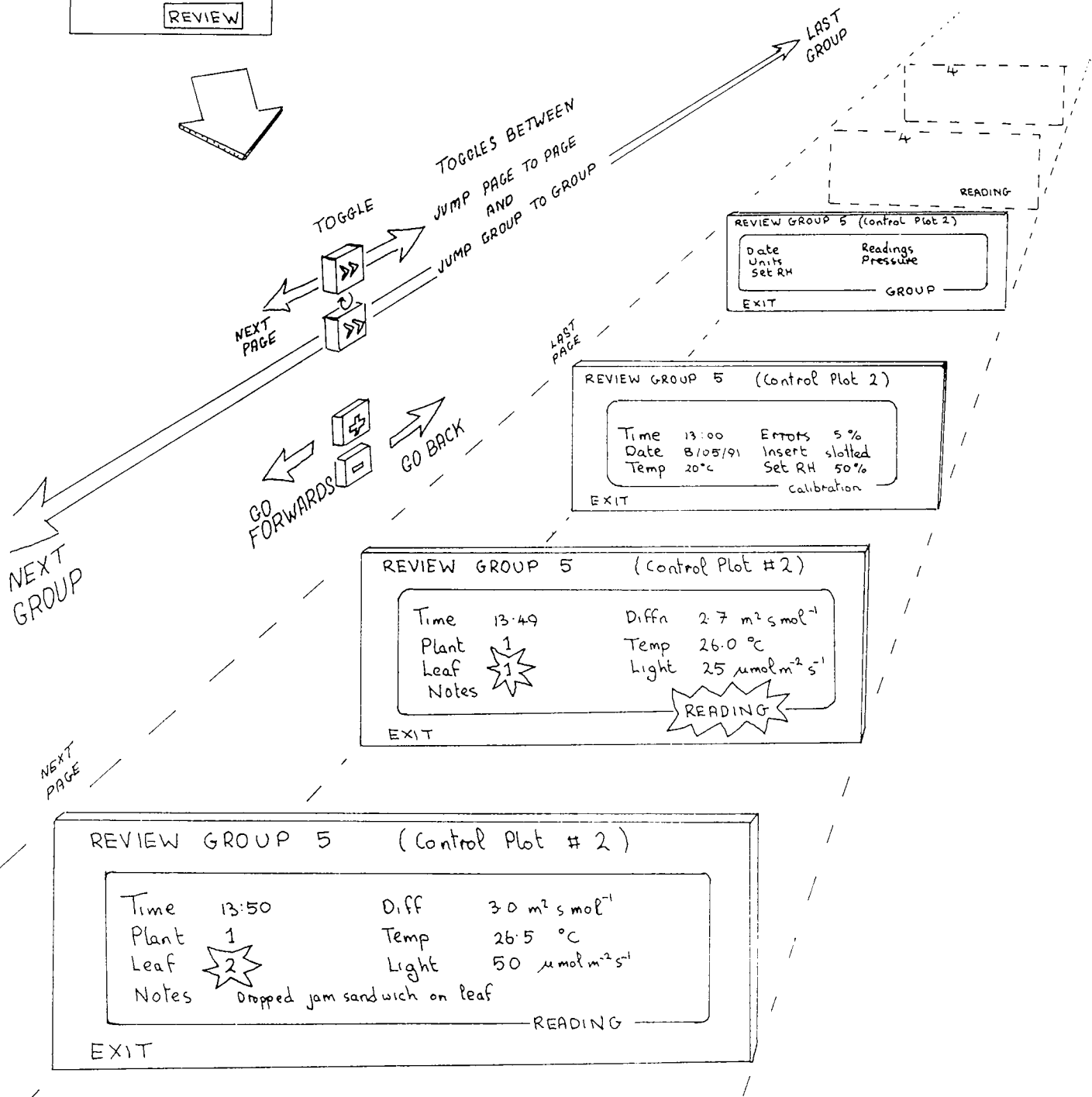
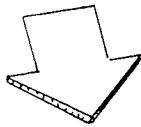

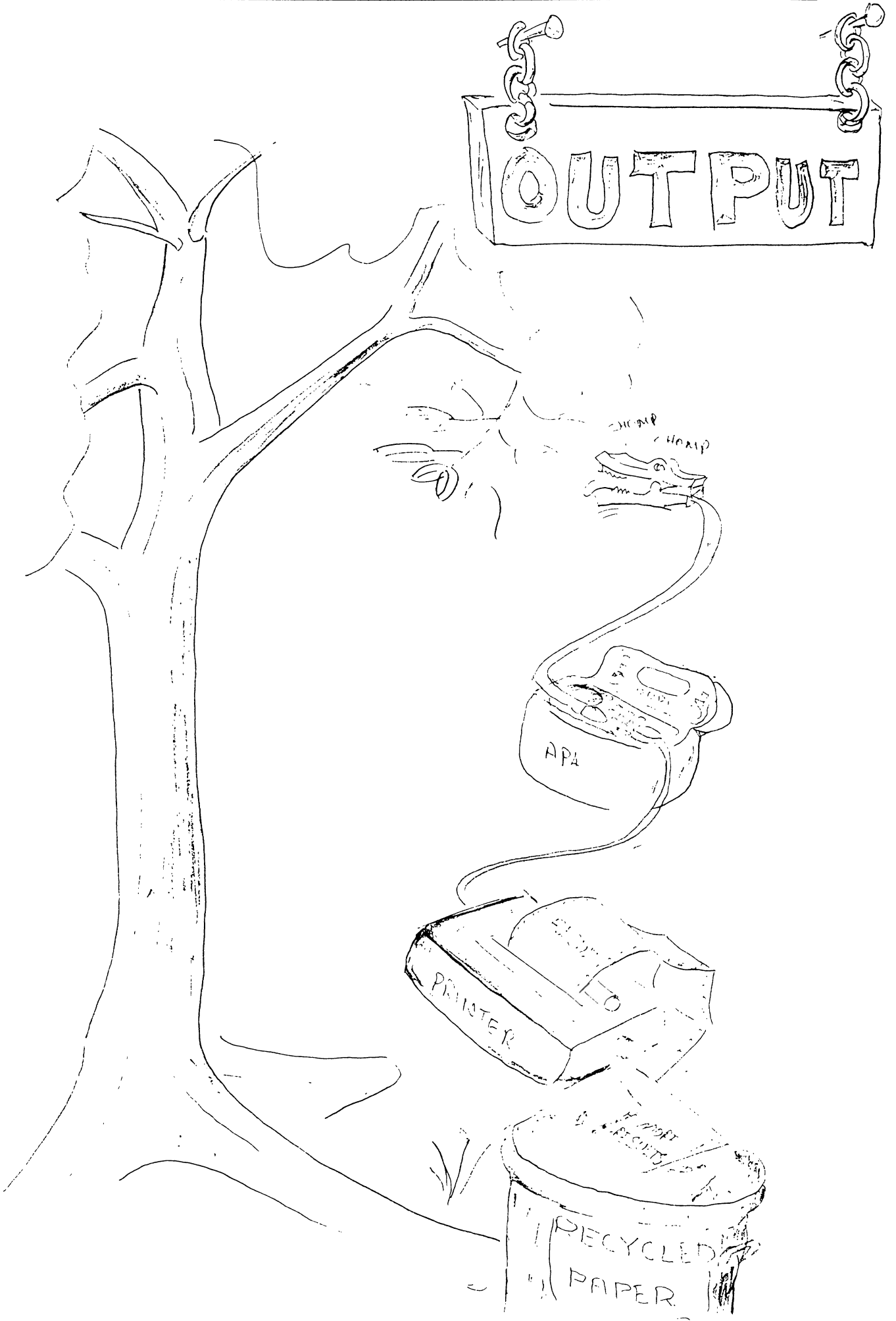

6.6 OUTPUT

OUTPUT READINGS

This section describes how to output data to a computer or printer. We have provided a fairly universal plug and adapter, and some software to download the data to your computer.

CONTENTS

- CONNECTION

- COMPUTER

- Preparing your computer
 - Installing the data retrieval software
 - Running the software
 - What happens on your computer screen

- PRINTER

- Printing direct to your printer
 - Controlling the AP4
 - Printer will not print

- TYPICAL PRINTOUT OF AP4 DATA

- SETTING THE RS-232 PARAMETERS

- HANDSHAKING

PLEASE NOTE:
AP4 RETRIEVE FOR WINDOWS SOFTWARE is now supplied.
We recommend you use it instead of the DOS software
documented here.
Please refer to APPENDIX C at the end of this manual.

CONNECTION

Connect the AP4's RS-232 output to the RS-232 (serial) port of your computer or printer. This port should have the name COM 1 on your computer.

WARNING : Do not connect it to a parallel port. It will not work

Use the ribbon cable that we supply if possible.

This is compatible with most PC, AT and XT computers and Epson-type printers.

Use the 25 to 9 pin adapter if you have to. The IBM PC/AT and some other computers need it .

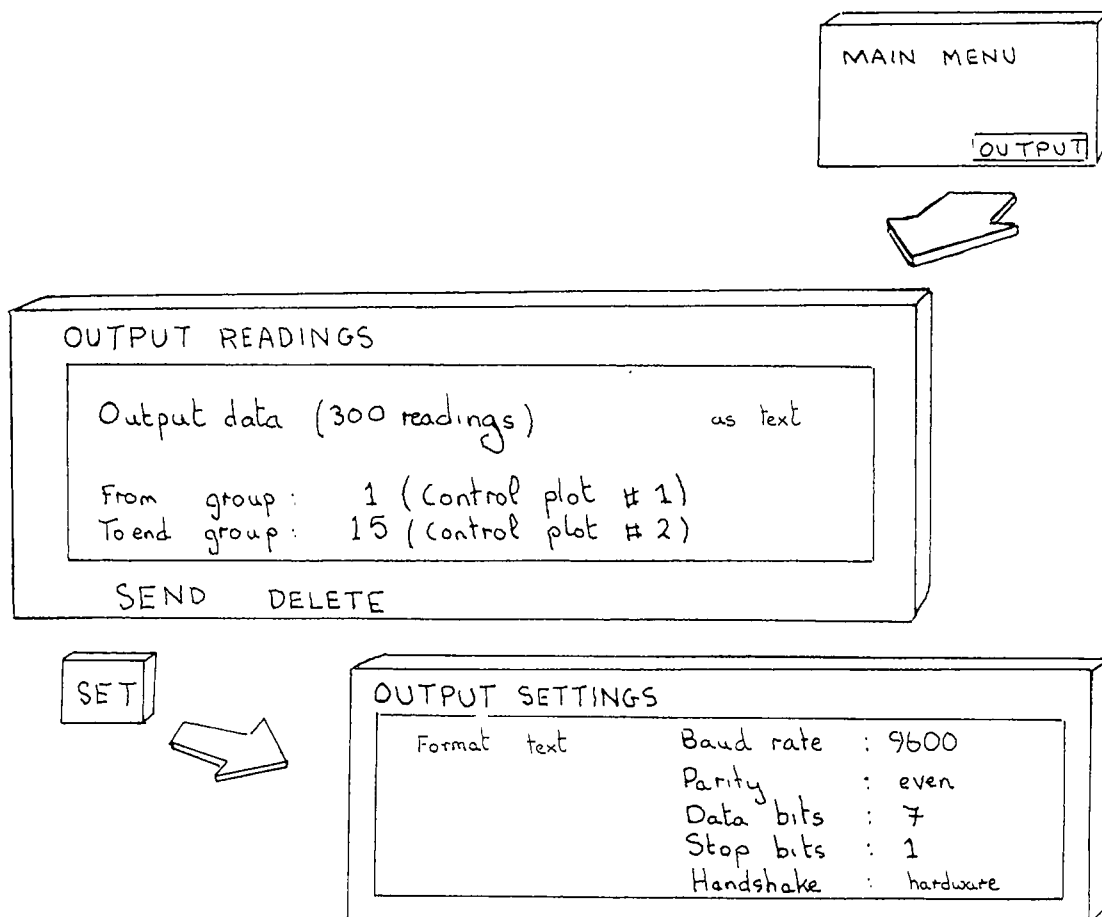

PREPARING YOUR COMPUTER

You have to run a program in the computer in order for it to retrieve the data. Otherwise the computer will not be ready and will just sit there forever contemplating its keyboard. We supply a program to do this, called RETRIEVE.EXE

The program, RETRIEVE.EXE, for running on IBM PC, AT or XT type computers, is supplied on both 3½ and 5¼ inch disk formats. It retrieves AP4 data and writes it to a disk file on your computer.

INSTALLING THE DATA RETRIEVAL SOFTWARE

Refer to your computer or DOS manual, if these steps are not clear:

Write-protect the original floppy disk.

Copy RETRIEVE.EXE to a floppy disk or hard disk sub-directory.

Store the original floppy disk in a cool, dry, safe place.

RUNNING THE SOFTWARE

Change the current drive and/or directory to where you want the received AP4 data to be stored.

If a copy of RETRIEVE.EXE is not in the current directory, it needs a PATH in AUTOEXEC.BAT to the drive/directory where it resides or you need to prefix RETRIEVE <J with the PATH name, when starting the program.

Type: RETRIEVE <J to start the program.

RETRIEVE normally receives data through the computer's COM1 serial port. To use COM2 instead, type: RETRIEVE 2 <J to start the program.

When RETRIEVE appears on the PC screen, follow the instructions displayed. They lead you through the steps necessary to write AP4 data to a disk file on the PC:

WHAT HAPPENS ON YOUR COMPUTER SCREEN

The first screen gives instructions on how to connect & set the AP4:

You have a choice of file format: "CSV" or "text":

Use "CSV" (Comma Separated Values) if you want to import the data into a spreadsheet or other program that recognises this format. "CSV" files include the RH transit times (in ms), the AP4's raw data.

Use "text" if you want to just store, view or print the data on the computer's printer. "Text" files do not include the RH transit times.

The jargon in the right hand column refers to the RS232 serial interface parameters. Beginners should change nothing. Just try the default settings. The RETRIEVE software expects the AP4 to be set up as shown opposite on screen 1. In the event that someone has been tinkering with these - perhaps a colleague changed them to connect up a printer - then you may have to change them back. See *Setting the RS232 Parameters* at the back of this chapter for further details.

The second screen requires you to enter the name of the disk file for the AP4 data. A list of files in the current directory is displayed.

The third screen tells you to select on the AP4 which group of readings the transmission should start from.

When transmission is started, the number of bytes of data received are displayed on the PC screen, while the AP4 displays a bar-graph, showing the percentage of the readings transmitted.

The fourth RETRIEVE screen displays confirmatory information on the file received.

Check that this is as expected.

If the first line says "transmission interrupted", or if the data format is "unknown", repeat the transmission & check your cable, serial parameters & handshaking.

AP4 - data retrieval software

To transfer data from the AP4 to a disk file proceed as follows:

- Connect AP4 to PC serial port COM1
- From AP4 MAIN MENU select **OUTPUT** and press **GO**
- Press **SET** and set AP4 OUTPUT SETTINGS as below:

OUTPUT SETTINGS:

Format: CSU	Baud rate: 9600
1	Parity : even
1	Data bits: 7
	Stop bits: 1
	Handshake: hardware

or
text
if
preferred

- At PC keyboard press **<J** to continue, or **Esc** to exit..

Version 1.05 Delta-T Devices Ltd, Cambridge, UK

AP4 - data retrieval software

- Enter name of disk file (or press **Esc** to exit program):

Files on default directory C:\FORTH\POLY\RETRIEVE

2AND3.CAL	3ONLY.CAL	CS_41.CAL	MODATA	RET1.PIX
RETRIEVE.EXE	RETRIEVE.PIX	SPALDING.CAL	TEST.AP4	

AP4 - data retrieval software

- On AP4 OUTPUT READINGS screen specify which group to start output from:

OUTPUT READINGS:

Output data (xxx readings) as **CSU/text**

From group: **yy** ()

To end group: **zz** ()

SEND **DELETE**

- Press **GO** when ready..

Awaiting data from AP4

- ..or press **Esc** to exit program

Version 1.05 Delta-T Devices Ltd, Cambridge, UK

AP4 - data retrieval software

- **1321** bytes of data received ok
- Data format is **CSU**
- Data written to disk file: **TEST2.CSU**
on directory **C:\FORTH\POLY\RETRIEVE**
- At PC keyboard press **<J** to retrieve another data file..
or press **Esc** to exit program

Version 1.05 Delta-T Devices Ltd, Cambridge, UK

PRINTING DIRECT TO A PRINTER

Connect the AP4 to your printer serial port as described above.

Do not connect it to a parallel port

Find out its RS232 communications parameters

Set it to on-line.

It should now be ready to receive data.

CONTROLLING THE AP4

Connect an RS232 cable as described above.

Select **text** format on the OUTPUT SETTINGS screen.

Set the communications parameters to match the printer, as described below.

Press **GO** to accept the output settings and return to the OUTPUT screen.

Here you can now optionally change the number of the first group of data being sent.

Press **GO** to **SEND**

Whilst the data is being sent you can tell the porometer to **PAUSE** temporarily, **GO** will start it again.

You can alternatively decide to delete the data. The software will ask you twice, to prevent mistakes.

PRINTER WON'T PRINT?

Check the RS232 parameters are set correctly, see below.

Check the cable is plugged in to the correct (serial) socket in the printer.

Check the printer manual.

Check the printer is on-line.

If it starts to print and then garbage appears, see Handshaking, below.

If your printer has a choice of Postscript and something else, do not use the Postscript option. It will not work. (*Postscript is used in desktop publishing*)

TYPICAL PRINT OUT OF DATA FROM THE AP4

TITLE: Garden plants Output : 21/05/91 12:19 pm

GROUP 4: 2.19 exercises Date : 21/05/91 Set RH: 45% Units: mmol/m²/s
Press: 1000 hPa

CALIBRATION:	Time : 10:49 am	Posn. ms	Cup T	Cup-Leaf
	Date : 21/05/91	-----	-----	-----
	Set RH : 45%	1 11315	23.4	0.0
	Insert : slotted	2 6804	23.5	0.2
	Errors : 5.0%	3 2127	23.3	0.4
		4 777	23.3	0.5
		5 437	23.2	0.6
		6 297	23.7	1.0

Time	Plant	Leaf	Conduct.	Cup T	Cup-Leaf	Light	Notes

10:52 am	1	1	1300	23.1	0.1	475	
10:53 am	1	2	81.0	22.8	0.6	40	top of leaf
10:55 am	1	3	325	23.3	-0.4	294	
10:56 am	1	4	740	22.7	0.8	292	nettle
10:58 am	1	5	51.0	22.1	1.0	208	daffodil
10:58 am	1	6	17.4	22.4	-0.9	1670	grass

GROUP 5: 2.19 plants(res) Date : 21/05/91 Set RH: 45% Units: s/cm
Press: 1000 hPa

Time	Plant	Leaf	Resist.	Cup T	Cup-Leaf	Light	Notes

11:32 am	1	1	0.51	24.4	1.3	1050	
11:32 am	1	2	1.13	24.0	1.5	350	
11:33 am	1	3	0.91	23.8	1.7	244	
11:34 am	1	4	0.88	23.6	1.7	252	grey leaves
11:35 am	2	1	0.61	22.8	1.4	212	
11:35 am	2	2	0.81	22.7	1.2	108	
11:36 am	2	3	0.90	22.5	1.1	182	
11:36 am	2	4	0.92	22.3	1.1	87	nettle
11:37 am	3	1	0.36	22.1	0.6	390	grass
11:38 am	3	2	0.36	22.1	0.3	405	
11:40 am	3	3	0.39	21.8	0.2	262	
11:41 am	4	1	0.66	22.1	-0.5	1550	rabbit food
11:41 am	4	2	0.74	22.4	-1.9	1530	
11:42 am	4	3	11.3	22.7	-1.4	1230	top surface

GROUP 6: 2.19 hse plants Date : 21/05/91 Set RH: 45% Units: s/cm
Press: 1000 hPa

Time	Plant	Leaf	Resist.	Cup T	Cup-Leaf	Light	Notes

11:45 am	1	1	79.0	23.3	-0.7	29	vargtd leaf dummy reading
11:46 am	1	2	12.6	23.5	-1.0	18	heptalureum
11:48 am	2	1	4.30	24.0	-1.1	85	
11:48 am	2	2	8.50	24.5	-1.2	29	
11:49 am	2	3	7.70	24.6	-1.1	69	marant

SETTING THE RS232 PARAMETERS

The Baud rate, parity, number of data bits and stop bits need to have the same settings at the AP4 and printer.

These settings are changed in the <SET> option under OUTPUT.

Baud rate : 300, 1200 or 9600

Both the porometer and the receiving instrument need to be set up to the same rate. It does no harm to try out a value to see if it works. If these options are not acceptable you will need to find out how to change these parameters on your printer.

Parity : none, odd or even

This is an embellishment which is sometimes used for checking for errors. Data is sent as a string of bits. An extra bit can be added as part of an error checking code. The terms odd and even refer to how the error checking code works. Sometimes receiving devices are set up to expect the parity bit but not use it. Don't worry if this seems obscure. All you have to do is ensure that your AP4 and the printer are the same.

Data bits : 7 or 8

Seven bits is the most popular (because you can represent the entire ASCII set of 128 characters with it). Try this first. If it does not work try eight.

Stop bits : 1 or 2

The stop bit or bits is a tidy way of finishing off the string of bits associated with each character. It is useful when the data is temporarily interrupted. Again, both machines need to match.

HANDSHAKING

Read this only if you get stuck.

Handshaking enables a computer or printer to control the stream of data it receives from AP4's RS-232 output. If it cannot keep up with the data flow from the AP4, it uses handshake signals to ask for a halt in data transmission. Then, when ready for more data, it uses handshake signals to re-start the AP4's transmission.

The OUTPUT, SET screen offers handshaking options: "hardware" or "none".

Select "hardware" handshaking, so that the computer or printer can control the data flow, using the AP4's CTS (Clear To Send) handshake line:

A low voltage (also called 1 or Mark) on CTS stops data being sent. A high CTS voltage (0 or space) enables data transmission. The computer or printer automatically uses the CTS line to manage the data flow.

Select "none" only if "hardware" handshaking causes some unforeseen problem.

If "none" is selected, the AP4 data is sent, without interruption. (at the speed selected in the "Baud rate" option)
At 9600 Baud, computers using floppy disks may not keep up. If so, a "communication error" will be indicated.
Printers are unlikely to keep up & some data will be lost, unless the printer's input buffer is larger than the amount of data being sent.

Jumper, J3, on the main circuit board (see below), selects whether the CTS handshake line is connected to pin 20 or pin 4 of the RS-232 connector. Pin 20 (J3 in position b, as supplied) is most commonly required. If there is a "communication error" message or loss data, then try moving J3 into its "a" position. The jumpers are on the main circuit board - see chapter 10.2 about opening the AP4 case.

Some unusual computers or printers may require another handshake line to tell them to be ready to receive data. If no data is received, when the AP4 is told to Send data, and the AP4's bar graph remains at 0%, first check your cable connections. Failing that try moving jumper, J4 to the "a" position. This causes +9V (also called 0 or space) to be asserted on pins 5, 6 & 8 of the 25-way connector, which should make the computer or printer ready to receive data.

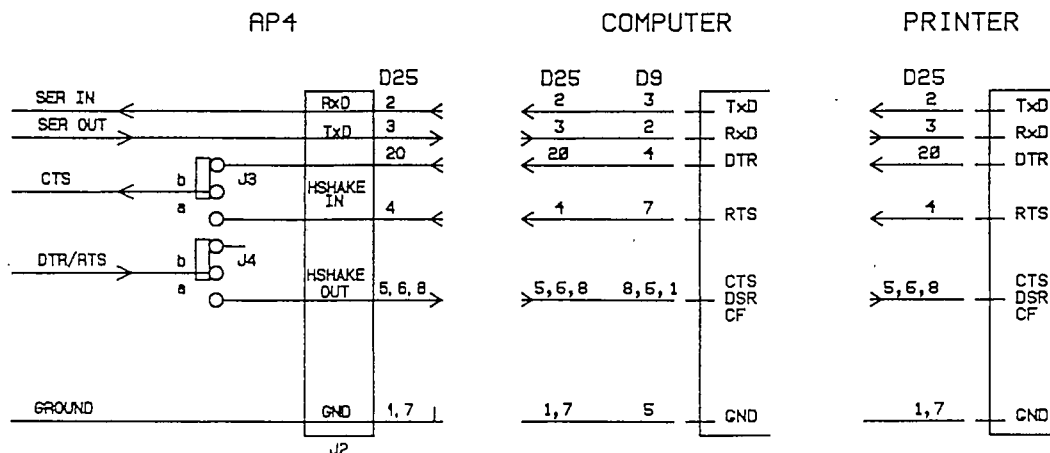

This page is blank.

7. PLANNING YOUR EXPERIMENT

- Checks
- How many readings?
- Memory usage
- Example plan
- How to calculate available memory

7.1 CHECKS

Is the porometer ready?

Check the following:

WHAT	WHERE	TEST	ACTION	See also : Chapter
Battery life	Turn on	100% = 20 hours	Recharge if low	Battery : 10
Memory	Turn on	100% = 632 to 1597 readings (depends on notes)	Delete or Output if low	Output : 6.6 How many readings : 7
Desiccant	Pocket in case	Pink or blue?	Renew if pink	How to renew desiccant : 10.4
Calibration Kit	Anywhere!	Do you have all the bits? Calibration plate Filter pad Tape Blotting paper or tissue Scissors Distilled water	Refresh calibration plate with damp filter paper.	How to Calibrate : 6.4
Cup shape	Sensor head	Slotted or round	Select	How to change cup : 10.3

Are you Ready?

Check that you know the following:

- How to calibrate, and when.
- How to record and output the data.
- What you are going to measure and why.
- What names you will use for the experiment and the groups of data.
- How many plants and leaves per plant you will measure.
- How long it will take? Do you have time?

Is the experiment ready?

- It may take a growing season to get ready.
- Contact a statistician, or get a good statistics book, for advice on how to ensure that your results are statistically significant.

7.2 HOW MANY READINGS TO TAKE

You can take nearly 1600 readings with no annotations added. This progressively reduces to 632 readings if you write a 30 character note with every reading. Unless you are Shakespeare this is unlikely to happen! Broadly speaking, we think you should be able to take readings for at least one day without filling up the memory. If you work hard you may start running out in 2 to 3 days, assuming an 8 hour day.

See *How to calculate available memory* if you want to know exactly.

7.3 MEMORY USAGE

The memory size is 32,000 bytes.

Each reading uses 20 bytes, with an optional 0 to 30 bytes overhead for any annotation you add (1 keyboard character = 1 byte).

The readings are kept in groups, each with its own optional name of up to 16 characters. There is a fixed overhead of 44 bytes per group.

The main title can also be up to 16 characters long.

Each group is identified by a number, as is each plant and each leaf.

7.4 EXAMPLE PLAN

Here is an example of how you might choose to plan an experiment.

Title : My first attempt

Number of groups = 4

Group names will be : Treatment 1, Treatment 2, Treatment 3
& Treatment 4

Number of plants in each group \square 5

Number of leaves per plant \square 5

So, total number of readings \square $4 \times 5 \times 5 = 100$

At one reading per minute expect to take about 2 hours.

Memo : remember to pack a drink and a jam sandwich.

Battery life \square 20% (say) [100% \approx 20 hours]

[This is a bit low - better recharge battery]

Free memory \square 20% (say)

[Should be OK for 126 readings at least, more if I keep down the annotation to a reasonable level. Someone must have left in a lot of data from last time. Do they want it or can I delete it now?]

Check desiccant. Blue? OK, but pink - replace.

Check Calibration Kit - see CHECKS above.

Is the calibration plate fresh, ie recently made up with damp filter paper?

Are the plants ready?

OK? ACTION! LET'S GO AND DO SOME SCIENCE!

7.5 HOW TO CALCULATE AVAILABLE MEMORY

1 reading uses 20 bytes

Each note uses 0 - 30 characters = 0 - 30 bytes.

Each group of readings uses an additional 44 bytes (independent of the length of the group name).

Memory size = 32000 bytes

$$\text{Number of readings} = \frac{a \times 32000}{20 + c} - b \times 44$$

where a = % memory left

- b □ number of groups of data
= number of experimental plots, for instance
- c = average length of annotation (0 to 30 characters)

Example (1)

Given : No notes
1 group

$$\begin{aligned} \text{Then : Maximum number of readings} &= \frac{32000 - 44}{20} \\ &= 1597 \text{ readings} \\ &= 1 \text{ readings every 18 seconds for} \\ &\quad 8 \text{ hours} \end{aligned}$$

Example (2)

Given : 30 characters of notes per reading
16 groups of readings

$$\begin{aligned} \text{Then : maximum number of readings} &= \frac{32000 - (16 \times 44)}{20 + 30} \\ &= 625 \text{ readings} \\ &\quad \square 1 \text{ reading every 46 seconds} \\ &\quad \text{for 8 hours.} \end{aligned}$$

So in normal use the AP4 should be able to cope with 1 days' data with no problem.

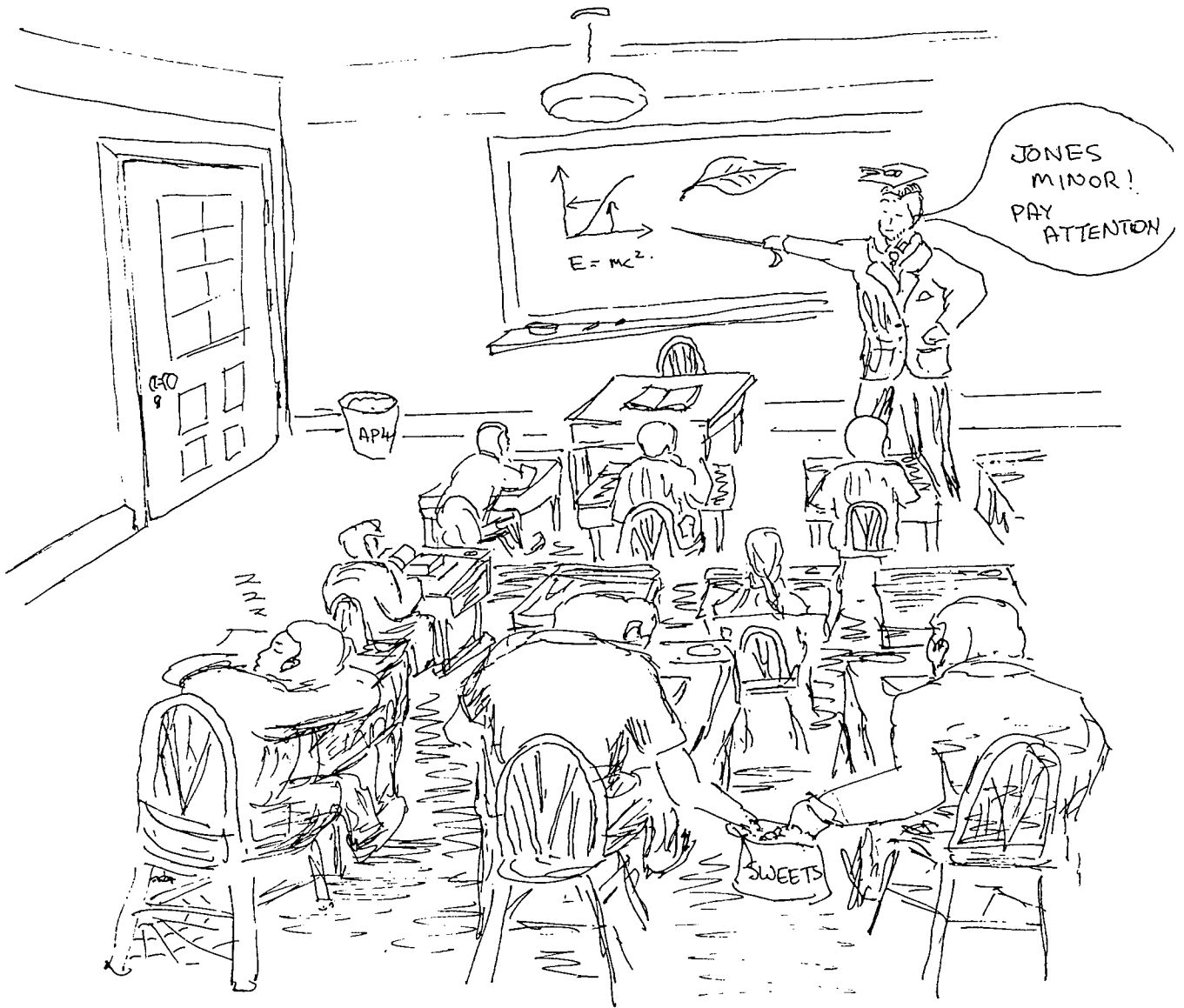

8. TUTORIAL

By now you should be able to take readings, calibrate, review and output the data. But it takes more to become an expert. This next section should help. We hope so, anyway.

- Hints and tips for good experimental technique.
- Explanation of resistance and conductance units.
- Barometric pressure considerations.
- Porometry and stomata.

8.1 HINTS AND TIPS

- In transit
- The first run of the day
- Choice of cup
- Leaf handling
- Sensitive stomata
- The cup-leaf seal
- Temperature management
- Leaf temperature
- Cup temperature
- Coping with very high resistances
- The light sensor
- Cleaning the sensor head

IN TRANSIT

Avoid shocks and keep the lid shut. The padded carrying case will give the AP4 some measure of protection when travelling to and from the field. It is not bomb-proof however and will not necessarily save the AP4 if you drop it! Keep the zip fasteners done up. They hold the AP4's lid shut and help to reduce the ingress of dirt and dust.

Avoid high temperatures. Leaving the AP4 in a closed vehicle in the sun can easily expose it to $>50^{\circ}\text{C}$. Likewise avoid the opposite extreme, where falling temperatures could lead to dew or condensation forming on the instrument. Bringing a cold porometer into a warm greenhouse may also cause condensation. Give it time to equilibrate.

THE FIRST RUN OF THE DAY

Make up the calibration plate well ahead of time. Leave it in its plastic wallet, stored in the head pocket in the AP4 case. A freshly made up plate needs about 1 hour to stabilise. If you do not do this the measured resistance (after calibrating) may be in error by 15%.

At 20°C and 50 % RH we found that the calibration plate will stay fresh, with its measured resistance within $\pm 5\%$, for several *days* in its wallet, and up to 18 hours out of the wallet. It will be shorter at higher temperatures and lower RH's.

So make up the plate the day before. That would also be a convenient time to make sure the correct cup shape is installed in the sensor head.

When starting up the AP4, first use it to measure the ambient RH. Select the cycling level nearest to this RH, then leave the instrument to cycle on one of the calibration plate positions for maybe 10 or 15 minutes. This gives the cup time to acclimatise to the current RH. During storage it may have been quite different, resulting in different equilibrium concentrations of moisture in the cup walls.

The calibration run can now be done with the expectation that a stable reading will be obtained within a few cycles of changing to each new plate position. It's a matter of personal preference whether you work through the calibration plate from position 1 to 6, or in the reverse order - it doesn't affect the final result. The "6 to 1" lobby say the high resistance end, position 1, takes longest to equilibrate, so do it last. The "1 to 6" lobby say do the slowest reading first, in case it takes forever. At extreme conditions, for example 5°C and 80 %RH ambient this may be a problem. It really does not matter which one you choose. Just wait for the readings to stabilise.

The same considerations apply when the ambient RH changes. Allow 5 or 10 minutes for the moisture in the cup walls to reach its new equilibrium concentration when you reset the RH Set point. You will know this when the calibration plate readings are stable.

When calibrating you have the option of curve-fitting after you have only measured four positions, but we strongly recommend you always do

all 6. Only in special situations should you accept less – for instance if you find a plate position which is impossibly slow, or if you are certain that the range you are working in is very small and will not exceed the shorter calibration range.

Avoid leaving the calibration plate (or a leaf) in the head when it is not cycling (e.g. when the Main Menu is displayed). The cup RH will rise to a high level, and it will take a further few minutes to stabilise when cycling is resumed.

CHOICE OF CUP

This depends on the shape, size and texture of leaf surfaces you are trying to measure. The leaf *must* cover the whole of the cup aperture – you can view the cup through the rubber pad to check this. In general, the slotted cup is preferable because it covers a larger area. Leaf stomata can be very unevenly distributed.

The other consideration is contact between the leaf and the rubber seal around the cup rim. The circular cup shape might be better for working between the veins of some leaves.

LEAF HANDLING

With the prospect of making hundreds of stomatal measurements in a session, it is worthwhile to optimise your technique so that you take readings as quickly as possible.

It is generally better to accept a reading after four or five cycles even though some drift is still apparent, rather than hang on for a possibly more accurate reading. The double beep gives you an indication of <2% change, but you may prefer to override this as you gain experience – or if you can't stand the noise! It also frees you from watching the display continuously.

The only caution to this procedure is when the new leaf temperature is substantially different from the previous one. You will probably see the cup-leaf δT moving, and you should wait until it stabilises. This version (2) of the AP4 automatically compensates for non-isothermal conditions, but the correction will be inaccurate if the measured δT is lagging behind the true value.

SENSITIVE STOMATA

The stomata of a few species start to close rapidly as soon as the light level is reduced by attaching the sensor head. If successive cycles give higher and higher resistance readings, this may be happening. Accepting a reading after the second or third cycle is your only option.

THE CUP-LEAF SEAL

Leakage between the cup seal and the leaf will lead to errors if the ambient RH differs much from the cycling RH level. Variability in successive cycles is the usual symptom of this. A quick test is to breathe over the sensor head. The next reading will show a considerably lower resistance if there is significant leakage. Reposition the sensor head to improve the seal.

TEMPERATURE MANAGEMENT

One of the more demanding aspects of field measurements (or indeed those in glasshouses) is keeping the sensor head near isothermal conditions (i.e. a cup-leaf δT of 0°C) whilst working in strong sunlight.

If exposed to direct solar radiation, the sensor head will heat up significantly above air temperature. Excessive handling will also warm it up. Leaves may be either hotter or cooler than air temperature, depending on their stomatal aperture, water stress and a number of other factors.

As far as possible therefore, keep the sensor head shaded and the shutter over the leaf-pad closed. If the δT can be kept $<1^{\circ}\text{C}$, you are doing well. The AP4 software will be applying its automatic correction anyway, and can cope with up to $\pm 2.5^{\circ}\text{C}$. You may occasionally have to tolerate a higher δT though. The dangers are twofold: the correction itself becomes less good as δT increases; and if the temperatures are not stable, the indicated δT may lag the true δT and introduce further error.

LEAF TEMPERATURE

What the AP4 calls leaf temperature (as in the cup-leaf δT) is the temperature of the leaf after it has been clipped into the sensor head and has equilibrated (more or less) with the cup.

This may be a few degrees different from the actual temperature of the undisturbed leaf. If you need the actual leaf temperature, you should measure it by some independent means. The AP4 readings are always related to the cup temperature to avoid confusion.

See also chapter 11.2, describing the temperature compensation algorithms.

CUP TEMPERATURE

The AP4 automatically corrects for deviations of the cup temperature from the temperature of the calibration run. Above a 5°C shift the AP4 will start to flag a warning by flashing. The correction is good, ie remains within specification, to + 10°C and - 5°C.

Beyond this, the correction is likely to become successively less accurate. You should run one or two calibration plate positions to check their resistances. If these are unacceptable, you will have to do a full calibration run at the new temperature.

COPING WITH VERY HIGH RESISTANCES

Problems can arise if the resistance is so high that the AP4 cannot complete even a single cycle. This could be the case for instance if you wanted to record the resistance of the top surface of a hypostomatous leaf along with the (much lower) undersurface resistances.

Terminate the reading by opening the head and breathing on it. Either discard the reading or add a note as a reminder.

THE LIGHT SENSOR

This is a simple sensor intended for comparative estimates of leaf irradiance. The spectral and cosine response approximate to that of a PAR quantum sensor, but no levelling device is provided.

After a resistance reading has been accepted and the sensor head unclipped from the leaf, the light sensor should be oriented in the plane of the leaf. The irradiance reading will be "frozen" at the moment of storing the data.

An irradiance value will get stored for every reading whether you want it or not. So it is advisable to note which are the valid readings.

CLEANING THE SENSOR HEAD

Deposits of dirt and plant substances, pollens and resins may accumulate on the rubber cup seal and even inside the walls of the cup.

Unplug the sensor head lead from the AP4.

Remove the cup seal and cup insert from the sensor head as shown in Chapter 10.3 and clean them, by washing with distilled water. Then leave them to dry out thoroughly for a day or so. If possible avoid the use of any solvents, which may damage or be absorbed by the silicone rubber. Spares are included in the consumables kit.

If the RH sensor itself appears dirty, use only a very soft brush to dislodge the dirt. Scratching the sensor may change its RH calibration.

Whilst you have the sensor head in pieces you can *wipe* the RH sensor with distilled water. Use a cotton bud - or a twist of cotton wool around a match stick. Be gentle. The sensor substrate is brittle, like glass. It is glued down on a finger-like extension of the head printed circuit board. Try not to get rest of the circuit board wet. The electronics do not like water. Leave it for a full day to dry out.

Some chemicals are known to produce permanent damage or a calibration shift in the RH sensor. Avoid all organic solvents and their vapours, cigarette smoke, sulphur dioxide and other sulphurous pollutants.

This page deliberately blank

8.2 RESISTANCE & CONDUCTANCE UNITS

RESISTANCE : r is defined by the relation

$$E = \delta\phi/r \quad \dots \dots \dots (1)$$

where

E is the flux density of water vapour,
 $\delta\phi$ is the concentration difference across the resistance r .

CONDUCTANCE : c is defined as the reciprocal of resistance

$$c = 1/r \quad \dots \dots \dots (2)$$

UNITS

Consistent units yielding "velocity" dimensions for r and c are:

E	ϕ	r	c
$\text{g m}^{-2} \text{s}^{-1}$ $\text{mol m}^{-2} \text{s}^{-1}$	g m^{-3} mol m^{-3}	s m^{-1}	m s^{-1}

By expressing concentration in dimensionless units of mol of water vapour per mol of air (mol mol^{-1} , effectively equivalent to the volume fraction vpm), the units for r become $\text{m}^2 \text{s mol}^{-1}$ ("mol" units).

E	ϕ	r	c
$\text{mol m}^{-2} \text{s}^{-1}$	mol mol^{-1}	$\text{m}^2 \text{s mol}^{-1}$	$\text{mol m}^{-2} \text{s}^{-1}$

CONVERSION FROM VELOCITY TO MOL UNITS OF RESISTANCE

$$r' = r V_0 (T/T_0) (P_0/P) \quad \text{where} \quad \dots \dots \dots (3)$$

r' is in $\text{m}^2 \text{s mol}^{-1}$

r is in s m^{-1}

V_0 is in $\text{m}^3 \text{mol}^{-1}$, the molar volume of air at T_0 and P_0 .

= $22.7 \times 10^{-3} \text{ m}^3 \text{mol}^{-1}$ at 273 K and 1000 hPa (mbar)

T is in $^{\circ}\text{K}$

For $r = 0.1 \text{ s mm}^{-1}$ (= 1 s cm^{-1})

$r' = 2.44 \text{ m}^2 \text{s mol}^{-1}$ at 293 K

PRESSURE AND TEMPERATURE DEPENDENCE

Fick's law of diffusion is $E = D \delta\phi/\delta x$ (4)

where E is the mass flow rate,
D is the diffusion coefficient of water vapour,
and $\delta\phi/\delta x$ the concentration gradient.

Comparison with equation (1), shows that r varies inversely with D.

D depends on the absolute temperature and pressure as follows :

$$D = D_0(T/T_0)^{1.75}(P_0/P) \quad (5)$$

where D_0 is the diffusion coefficient at reference values of T_0 and P_0 .
See also chapter 11.2 : *Resistance dependence on diffusion coefficient.*

CONCLUSIONS

- A. Resistance and conductance values expressed in velocity units are temperature and pressure dependent, by approximately 0.6% K^{-1} and 0.1% hPa^{-1} .

From (3) and (5), it can be seen that pressure effect is eliminated and the temperature effect is reduced to $(T/T_0)^{0.75}$ when mol units are used.

- B. Resistance and conductance values expressed in mol units are independent of pressure but are weakly dependent on temperature, by approximately 0.25% K^{-1} .

You may take readings with the AP4 in any of the following units:

Resistance : s cm^{-1} , s m^{-1} , m^2 s mol^{-1}
Conductance : cm s^{-1} , mm s^{-1} , $mmol$ m^{-2} s^{-1}

(0.1 s mm^{-1} = 1.0 s cm^{-1} = 100 s m^{-1} etc.)

The values are referred to the actual cup temperature of the reading, and the pressure setting that you entered at the start of the measurement session.

- If you wish to compare values in different units, remember that
a) conductance is the reciprocal of resistance
b) velocity units can be converted to mol units by (3) above

If you wish to compare readings in the same units, but taken at different temperatures and pressures, use equation (6) in chapter 11.2 for velocity units, and equation (3) above to convert to mol units.

Acknowledgements

The above arguments closely follow Chapter 10: Porometry, by Dr K.J.Parkinson in Instrumentation for environmental physiology (Eds B.Marshall & F.I.Woodward, Publ. Cambridge University Press, 1985).

8.3 BAROMETRIC PRESSURE

A STANDARDISED PRESSURE SETTING

This applies to "velocity" units, which are pressure dependent.

If you wish to standardise the readings to a preferred value (or if you do not know what the pressure is):

- Set the pressure to the preferred value (e.g. 1000 hPa)
- Calibrate, and then take leaf readings.

The readings will automatically be standardised to the set pressure value *provided that the pressure does not change in between the calibration and taking the readings.*

This is because the calibration plate and leaf resistance values move in unison.

Standardised readings have the advantage of being more immediately comparable, but you will have no record of the actual pressure at which the readings were made.

AN INCORRECT PRESSURE SETTING

Provided that the pressure does not change in between the calibration and taking the readings, the resistance values will not be in error, they will merely be referenced to the set pressure value. (The stored set pressure value will of course be incorrect though).

FAILURE TO RECALIBRATE WHEN THE PRESSURE CHANGES

The resistance values will be in error by an amount proportional to the change.

Barometric pressure at sea level may swing between extremes of 960 - 1040 hPa, but changes of more than a few hPa in a day are unusual. This is unlikely to lead to significant errors and you may choose to ignore it.

Larger changes in pressure can occur with changes in altitude (about 1 hPa per 10 m or 30 ft). If you move to a new site at a different elevation you may need to recalibrate.

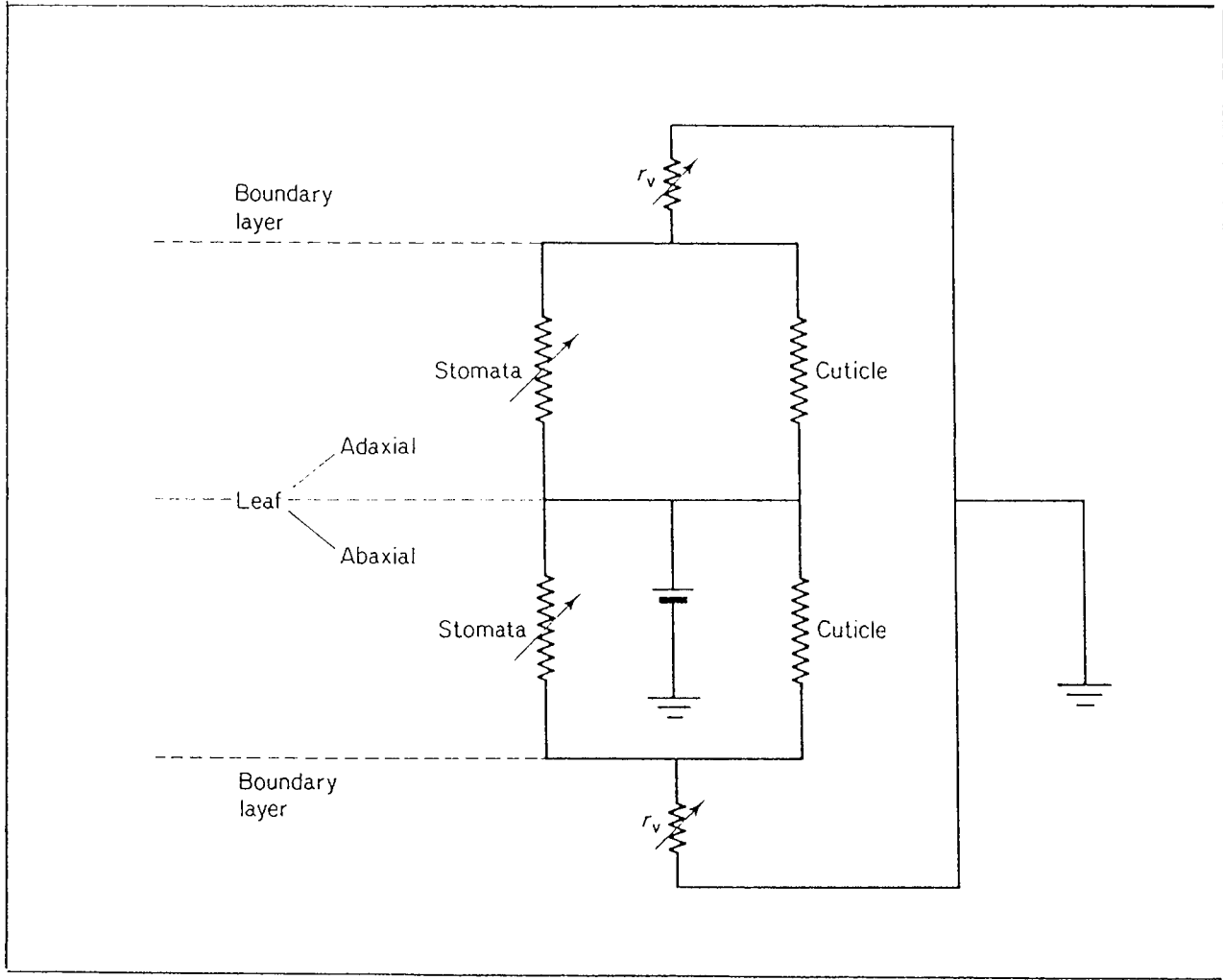

Equivalent electrical circuit for the loss of water vapour from a leaf by diffusion through the stomata and cuticle of the upper and lower epidermis.

(Reproduced with permission from Principles of Environmental Physics by J Monteith, published by Edward Arnold)

8.4 POROMETRY AND STOMATA

Porometry is the study of gaseous mass transfer through stomata.

When leaves transpire, water evaporates from cell walls and escapes to the atmosphere by diffusing into substomatal cavities, through stomatal pores, and finally through the leaf boundary layer into the free atmosphere. During photosynthesis, molecules of carbon dioxide follow the same diffusion path in the opposite direction. Rigorous treatments of diffusion through pores allow for the interaction of diffusing gases and for the difference in dry air pressure across pores needed to balance the difference in water vapour pressure. There is a class of problems in which these complications can not be ignored (e.g. in precise estimates of the intercellular CO₂ concentration) but for many practical purposes the elementary treatment which follows is adequate. It will therefore be assumed that for a leaf lamina, the resistance of stomatal pores for a particular gas depends only on their geometry, size and spacing whereas the resistance offered by the boundary layer depends on leaf dimensions and windspeed.

Meidner and Mansfield (1968) tabulated stomatal populations and dimensions for 27 species including crop plants, deciduous trees and evergreens. The leaves of many species have between 100 and 200 stomata per mm² distributed on both the upper and lower epidermis (amphistomatous leaf) or on the lower surface only (hypostomatous leaf). The length of the pore is commonly between 10 and 30 μm and the area occupied by a complete stoma, including the guard cell responsible for opening and shutting the pore, ranges from 25 x 17 μm in *Medicago sativa* to 72 x 42 μm in *Phyllitis scolopendrium*.

Because stomata tend to be smaller in leaves where they are more numerous, the fraction of the leaf surface occupied by pores does not vary much between species and is about 1% on average for a pore width of 6 μm. There is a much greater variation in the geometry of pores: the stomata of grasses are usually long, narrow, and aligned in rows parallel to the midrib whereas the elliptical stomata of sugar beet (*Beta vulgaris*) and broad bean (*Vicia faba*) are randomly oriented but uniformly dispersed over the epidermis.

The network of resistances in the diagram opposite is an electrical analogue for the diffusion of water vapour between the intercellular spaces and the external air. The calculation of boundary layer resistance is discussed in Monteith (1980). Values of 0.3 to 1 s cm⁻¹ are expected for small leaves in a light wind. Many mesophytes have minimum stomatal resistances in the range 1 to 2 s cm⁻¹ but values as small as 0.5 s cm⁻¹ and as large as 4.8 s cm⁻¹ have been reported for *Beta vulgaris* and *Phaseolus vulgaris* respectively. Xerophytes have larger minimum resistances up to 30 s cm⁻¹. Cuticular resistances range from 20 to 60 s cm⁻¹ in mesophytes and from 40 to 400 s cm⁻¹ in xerophytes. In both types of plant, the resistance of the cuticle is usually so much larger than the stomatal resistance that its role in water vapour and CO₂ transfer can generally be ignored.

(Reproduced with permission from *Principles of Environmental Physics* by J Monteith, published by Edward Arnold)

This page blank.

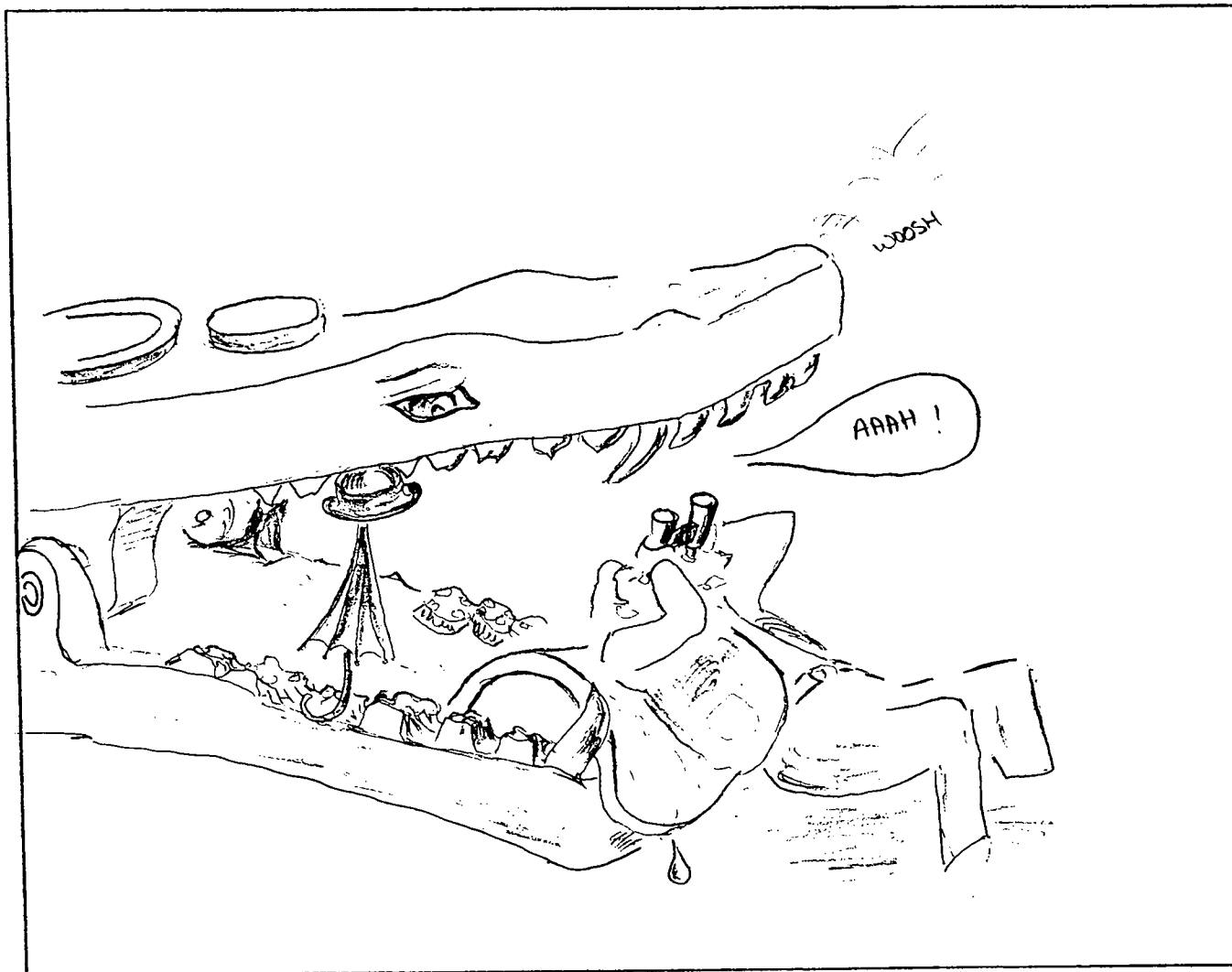

TECHNICAL SECTION

The rest of the manual should only concern you if things need servicing, or if you are interested in the design. There is also a bug report form. You can tear it out and send it to us. We would like to hear your comments, ideas and criticisms.

9	SPECIFICATIONS	93
10	HOW TO SERVICE	97
10.1	Battery	98
10.2	Case and chassis : How to undo them	101
10.3	Cup : : How to change it	104
10.4	Desiccant : : How to change it	106
10.5	Eprom : : How to change it	107
10.6	Head : : How to disassemble	110
10.7	Pump : : How to change it	111
10.8	Light Sensor : : Calibration	112
10.9	RH Sensor : : Calibration	113
10.10	Thermistors : : Calibration	115
10.11	Software crashes : How to reset	116
10.12	Trouble shooting.	117
11	HOW IT WORKS	119
11.1	What happens in the head	121
11.2	How the results are calculated	123
11.3	How the electronics work	141
12	CIRCUIT DIAGRAMS	145
13	COMPONENTS & CONNECTORS	153
14	SPARES, CONSUMABLES AND ACCESSORIES	159
15	SERVICE AND GUARANTEE	161
APPENDIX A : DESIGN OF THE AP4		163
	Dynamic modelling of cup performance	164
	Refinement of calibration plate values	168
APPENDIX B : TEST RESULTS		171
	Comparison with Mark 3 Porometer	172
	Temperature correction test results	174
REFERENCES		183

This page blank

9. SPECIFICATIONS

SENSOR HEAD

Size: 110 x 30 x 27 mm
 Weight : 130 g (including cable)
 Cup apertures: 2.5 x 17.5 mm (slot with rounded ends)
 6.0 mm dia (circular)
 Cable length: 1.2 m
 RH sensor: Vaisala type 1518HM, thin film capacitor
 Temperature sensors: Betatherm 100K (curve 6) microchip thermistors
 accuracy : $\pm 0.1^{\circ}\text{C}$ at 25°C
 $\pm 0.3^{\circ}\text{C}$ at 0 & 50°C
 Light sensor: unfiltered GaAsP photodiode

CARRYING CASE

Description : padded, with shoulder and waist straps
 Size: 300 x 220 x 140 mm
 Total weight: 3 kg

CONTROL UNIT

Interfaces : Control panel with 8 lines x 40 character LCD display.
 QWERTY keypad for annotation.
 RS-232 interface.
 Pocket for sensor head, desiccant and calibration plate.

PROM Software Version 2

Functions : read, calibrate, review and output.
 automatic calibration curve fitting
 automatic temperature correction

Choice of units:

Resistance : s cm^{-1} , s m^{-1} , $\text{m}^2 \text{s mol}^{-1}$
 Conductance : cm s^{-1} , mm s^{-1} , $\text{mmol m}^{-2} \text{s}^{-1}$

Battery : Duration : 20 h
 Life expectancy: 200 to 2000 recharge cycles
 Charging: 12 to 15 V dc, 0.5 A
 Recharge time : approx 14 hours

Memory : 32 kbytes, approx. 630 to 1600 readings depending on the extent of added notes.

RS-232 UNIVERSAL CABLE & ADAPTER

RS-232: 1.5 m cable with 25-pin male and female connectors and 9-25 pin adapter, for printers and IBM-PC/AT/XT compatible computers, up to 9600 baud.

Specifications

DATA COLLECTION SOFTWARE

Filename : RETRIEVE
Function : Collects data from AP4 and saves to a file on your computer.
File format : Comma separated values (CSV) and ASCII text
Compatibility : For use with IBM PC, AT & XT computers.
Disk sizes : 3.5" and 5.25" disks both supplied with all orders.

OPERATING LIMITS

Temperature : 0 to 50°C
Humidity : 10 to 90 %RH (non-condensing)

CALIBRATION PLATE VALUES (at 20°C, 1000 hPa)

Plate position	Resistance			Conductance		
	s/cm	s/m	m ² .s/mol	cm/s	mm/s	mmol/m ² .s
1	27.3	2730	66.51	0.04	0.37	15
2	16.5	1650	40.02	0.06	0.61	25
3	7.4	740	18.03	0.14	1.35	55
4	3.1	310	7.55	0.32	3.23	132
5	1.6	160	3.90	0.63	6.25	257
6	0.8	80	1.95	1.25	12.50	513

continued

PERFORMANCE SPECIFICATIONS (cont'd)

Parameter	Reading range	Resolution note [1]	Accuracy note [2]	Test Conditions
				Reading Range [5]
<i>Conductance</i>	5.0 - 1200 mmol m ⁻² s ⁻¹	0.1 - 10	>90 % >80 %	5 - 800 mmol m ⁻² s ⁻¹ 800 - 1200 mmol m ⁻² s ⁻¹
<i>Conductance</i>	0.25 - 30.0 mm s ⁻¹	0.01 - 0.1	>90 % >80 %	0.25 - 20 mm s ⁻¹ 20 - 30 mm s ⁻¹
<i>Resistance</i>	0.2 - 40 s cm ⁻¹	0.01 - 0.1	>90 % ± 0.2 s cm ⁻¹	0.5 - 40 s cm ⁻¹ 0.2 - 0.5 s cm ⁻¹
<i>RH</i>	0 - 100%	0.1	96%	
<i>Cup temp.</i>	-5 - +55 °C	0.1	± 0.7 °C	0 - 50 °C
<i>Cup-leaf temp.</i>	-5 - +5 °C	0.1	± 0.2 °C	0 - 50 °C
<i>PAR flux [3]</i>	0 - 2500 μmol m ⁻² s ⁻¹	10	>85%	
<i>Pressure</i>	600 - 1200 hPa (mb), settable in steps of 5 hPa			
<i>RH cycle level</i>	20 - 80 %RH, settable in steps of 5% [4]			

Notes:

- [1] Resolution varies with the magnitude of the value obtained. The range shown corresponds to the reading range. In relative terms, the resolution is better than 2%, but at least the smallest amount shown.
- [2] Accuracy is the extent with which the measurement agrees with the true value (100% is perfect), as verified by comparing plate readings with the reference value (for a specific temperature and pressure). The stated accuracy applies over the range of the calibration plate and for optimum cup conditions, i.e. from +10 to -5 °C difference between actual cup temp. and that existing at calibration, and for +2.5 to -2.5 °C difference between leaf and cup temperatures. The accuracy of the temperature sensors is expressed as the error, the deviation possible from the true value.
- [3] Spectral and cosine responses are approximate only.
- [4] Cycling at extreme combinations of temperature, conductance and RH level may not always be possible.
- [5] For Ambient RH 10 – 90%.

CE CONFORMITY

The Porometer type AP4 conforms to EC regulations regarding electromagnetic emissions and susceptibility when used according to the instructions contained within this user manual, and is CE marked by Delta-T Devices Ltd.

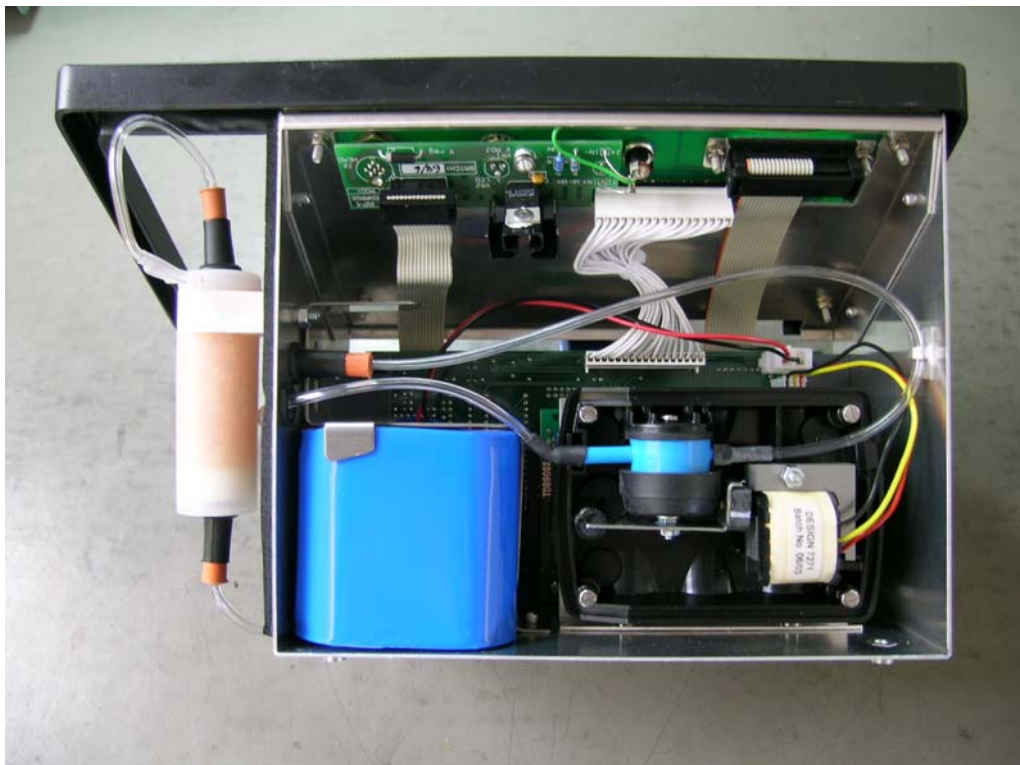

PLEASE NOTE!
See Appendix E: AP4 BATTERY DESIGN CHANGE

10. HOW TO SERVICE

CONTENTS

	Page
10.1 Battery : Recharge : Care : Storage : Change	98
10.2 Case and chassis : How to undo them	101
10.3 Cup : : How to change it	104
10.4 Desiccant : : How to change it	106
10.5 Eprom : : How to change it	107
10.6 Head : : How to disassemble	110
10.7 Pump : : How to change it	111
10.8 Light Sensor : : Calibration	112
10.9 RH Sensor : : Calibration	113
10.10 Thermistors : : Calibration	114
10.11 Software crashes : How to reset	116
10.12 Trouble shooting :	117

10.1 BATTERY

- Recharge
- Care
- Storage
- Replacement

BATTERY RECHARGING

The AP4 contains an 8 Volt, 2.5 Ah sealed lead acid battery. It takes about 14 hours to recharge. It has plenty of capacity for normal use:

Typical current consumptions are:

SLEEP (clock & data memory retention)	= 20 μ A
ON (normal use, not pumping)	= 50mA
PUMP (depending on pump rate)	= 50 to 500mA

Thus a normal average current is about 100 mA, depending on pump usage.

The 2.5 Ah battery should last for over 20 hours of this use. New batteries have a lower capacity that builds up over the first few charge/discharge cycles.

When the remaining battery capacity falls to 15%, the AP4 display shows a warning that the battery is getting low. At 10% the AP4 shows a warning, "SHUTTING DOWN" and switches itself off to ensure data memory retention for at least another 2 weeks.

The sleep consumption, when the AP4 is switched off, is negligible and will normally be exceeded by the battery's self-leakage. The self leakage is very temperature dependent, as can be seen from the maximum storage time graph, which shows the time for a fully charged battery to discharge through self leakage.

BATTERY CARE

The lead acid battery should give many years of useful life, provided it is never deeply discharged:

ALWAYS PROMPTLY RECHARGE THE BATTERY WHEN IT'S RUN DOWN:

Connect the AP4 charger the CHARGE socket.
The CHARGE indication LED should light.

The Porometer's battery life % indication on the first screen should rapidly increase. While charging, the % charge indication over-reads. A low battery takes about 16 hours to recharge.

It can be left on charge for several days without harm.
The Porometer can be used as normal during charging.

Since the Porometer contains its own battery charge regulator, any 12 to 15 Volt DC supply can be used as a charger, including laboratory power supplies and 12V car batteries, connected by a 2.1mm co-axial "power" plug with the INNER POSITIVE.

A rising battery life % indication confirms that the battery is actually charging.

If the battery is deeply discharged, recharge it as soon as possible. When an AP4 with a flat battery is turned on it may display the warning, "SHUTTING DOWN" and then switch off. An AP4 with a completely flat battery won't even turn on. When deeply discharged it may take a long time, even days, before it starts to accept charge, and then it may have reduced capacity.

The stored readings and the time/date may have been lost.
Re-set the time and date, if necessary, using <SET>.

STORAGE

THE BATTERY MUST BE CHARGED BEFORE AND PERIODICALLY DURING STORAGE,
to prevent deep discharge due to gradual self-leakage.

Recharge all batteries at least once a year.
For storage temperatures above 20°C, recharge more frequently.
See "Maximum Storage Time" graph, which shows the time for complete self-discharge of a fully charged battery.
We recommend recharging at least twice as frequently as indicated by this graph.

Any spare batteries should be rotated & recharged at these rates. See 10.2 for undoing the AP4 case to reach the battery.

A fully charged battery has an open circuit voltage of about 8.7 V, falling to 7.9 V when discharged.

WARNING:

*Do not short circuit the battery.
When connected to the AP4, the battery is protected by a self-resetting thermal fuse on the main circuit board.
If the battery is somehow accidentally shorted directly, there is a risk of fire or explosion.*

GRAPH SHOWING THE TIME IT TAKES
THE BATTERY TO SELF DISCHARGE

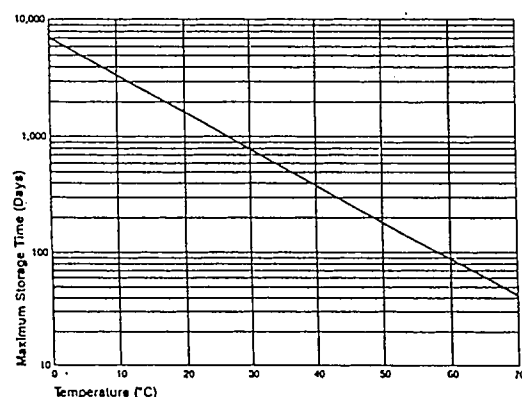

BATTERY CHANGING

Remove the chassis from the case as described in Chapter 10.2

Disconnect the battery connector from the top right hand side of the main circuit board.

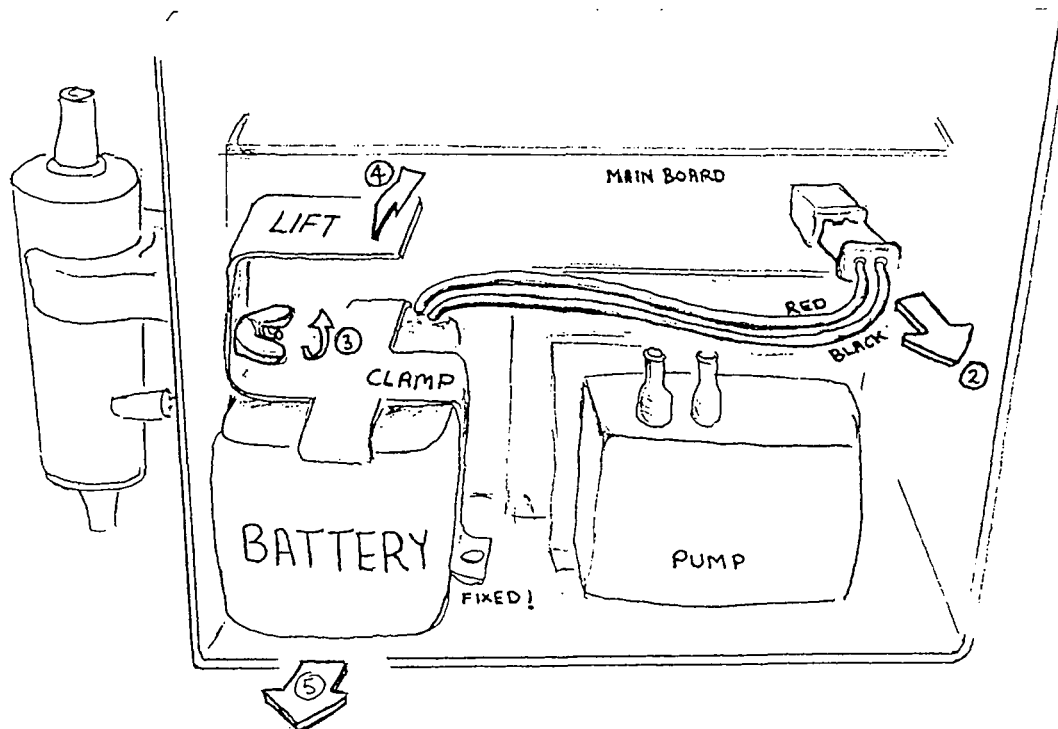

Loosen the wing nut that secures the battery clamp, lift the clamp up enough to clear the battery, then carefully slide the battery with its wires and connector clear.

When fitting the new battery simply reverse the procedure but pay special attention not to trap the wires under the battery clamp. Feed them through first.

10.2 CASE AND CHASSIS : HOW TO UNDO IT

REMOVE THE BAG FIRST

Unzip the bag completely around the lid section.

Slide fingers between lid and bag to unhook the velcro from inside, then pull the bag clear of the lid.

Unhook velcro from case section in the same manner and slide the bag from the case assembly.

TO OPEN THE CASE

Lay the case on its front and using a steel rule or finger nails remove the four black rivets that hold the cover plate to the back of the case.

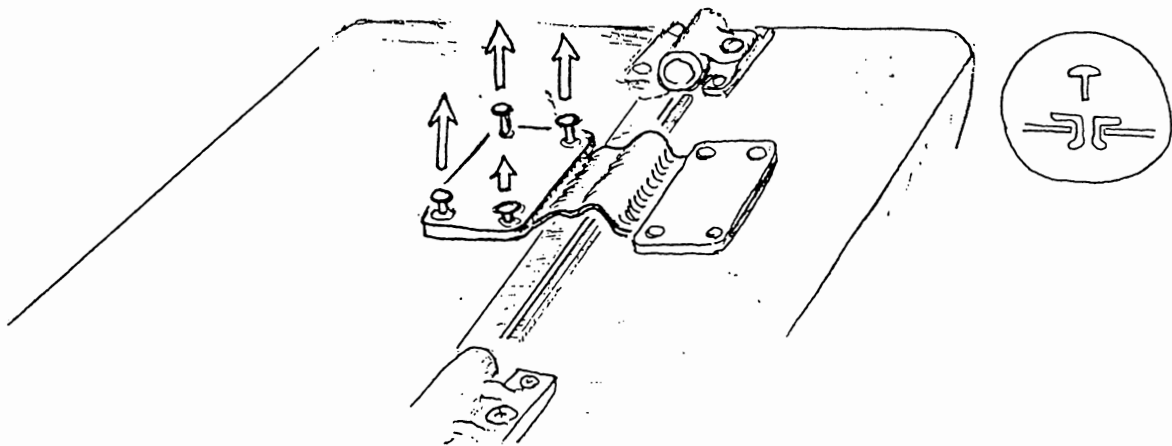

Remove the cover plate, grip the ribbon cable as close to its connector as possible and pull it clear from the case.



From the base of the case assembly remove the four screws that secure the chassis to the inside of the case.

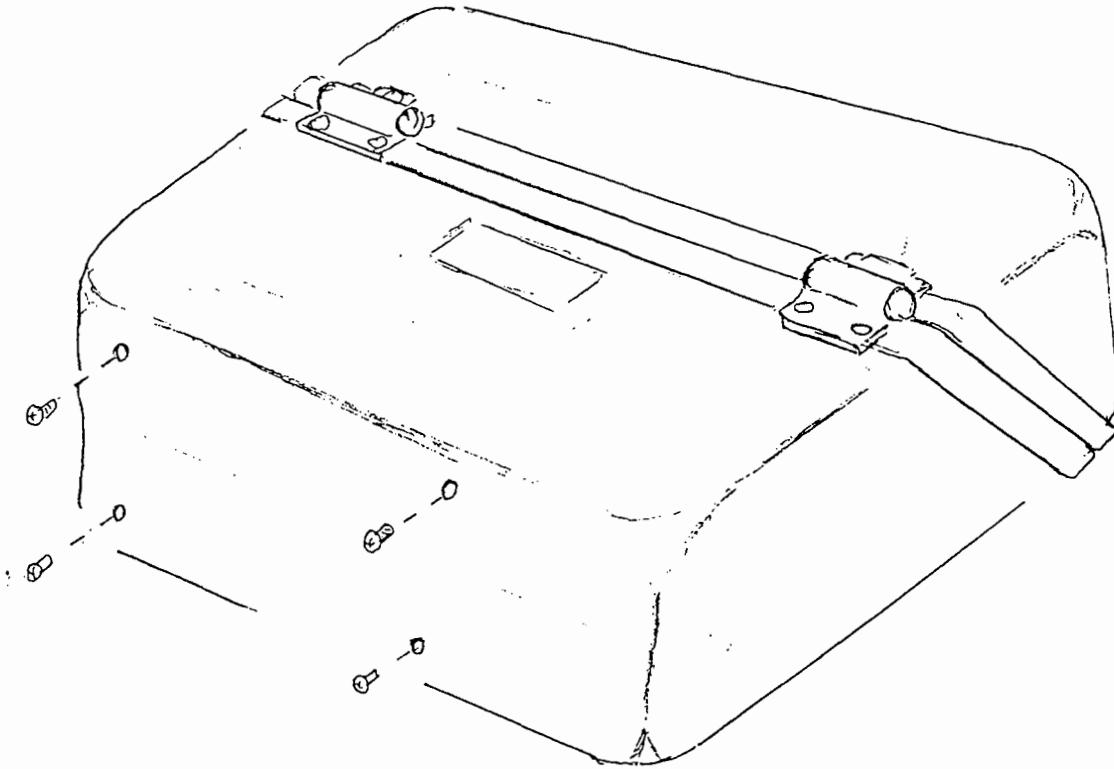

Disconnect the head assembly and remove it from the side pocket. Unclip the desiccant assembly from its white clip and disconnect the outlet pipe. Remove the desiccant assembly from the side pocket.

Seal the ends of the desiccant assembly so as to minimise the exposure to air. Use the blank bung and also the bung the head assembly.

With one hand on the plastic clip inside the side pocket and the other on the bezel at the other end gently ease the chassis assembly from the case. Note that excessive force should not be applied to the bezel in an effort to remove the chassis from the case. See also Page 96.

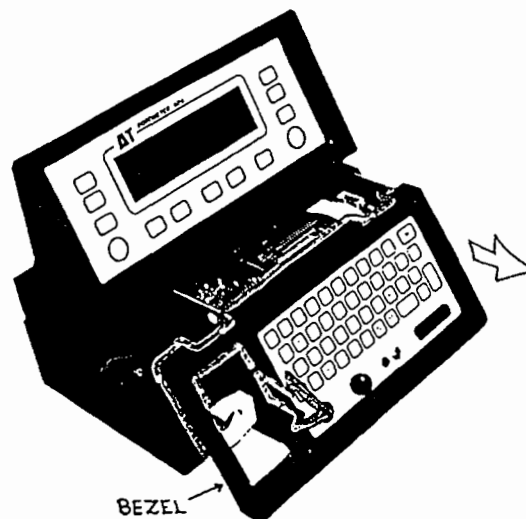

Once the chassis has been removed the desiccant assembly can be clipped back into place and the pump outlet pipe attached. Keep the top sealed with the blank bung to minimise exposure to air.

CHASSIS LAYOUT

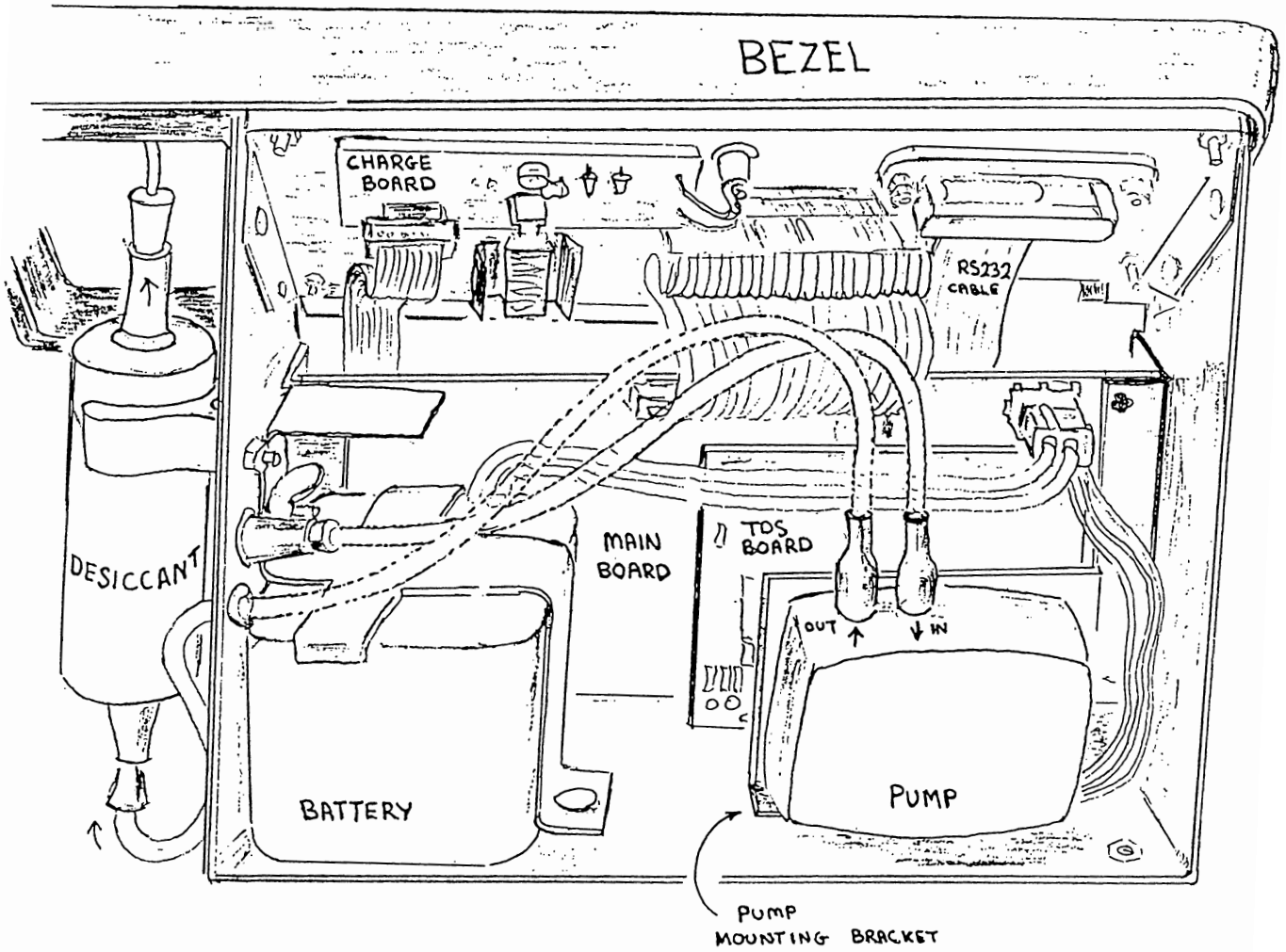

10.3 CUP : HOW TO CHANGE IT

DESCRIPTION

Two alternative cup shapes are provided in the head of the AP4. A long, narrow slot, 2.5 x 17.5 mm, and a circular, 6 mm diameter aperture are both provided. Heads are shipped from the factory with the slot installed.

The active cup is pretty obvious. It is the one at the end of the head. You can see it through the sliding window.

The calibration plate is designed for use with either cup.

POROMETER HEAD WITH SLOTTED CUP INSTALLED

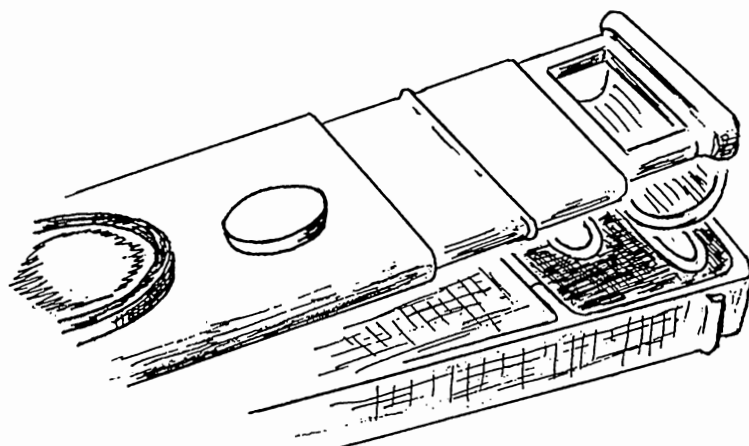

POROMETER HEAD DISASSEMBLED : Showing rubber seal and cup insert

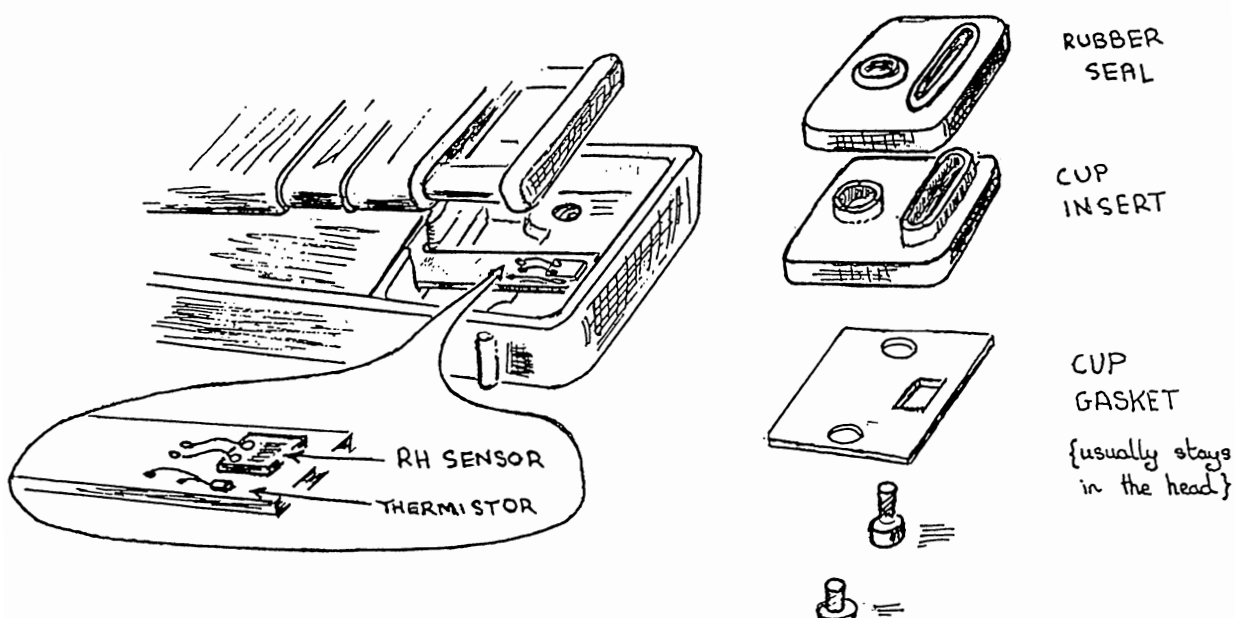

CHANGING THE CUP

Disassemble the two halves of the head unit, see Chapter 10.6

Unscrew the two large plastic screws readily visible on the outside of the head.

Gently tease out the rubber seal and cup insert.

WARNING

Take care not to touch, or shock the fragile RH sensor

Do not use organic solvents on or near the RH sensor

You can now rotate and replace cup insert and seal.

Do up the screws until you just feel some resistance, and then tighten up one more quarter turn.

WARNING

Avoid overtightening the screws. They are stronger than the plastic of the insert and may strip out the thread.

Change the cup type in the Calibration Settings.

10.4 DESICCANT - HOW TO CHANGE IT

Unclip the desiccant container and remove it from the white plastic spring clip in the pocket to the left of the QWERTY keyboard.

Unplug the translucent air lines.

Open the hinged container. It opens at one end.

Either replace the desiccant with fresh self indicating silica gel crystals, or reconstitute the crystals - see below.

Reassemble.

RECONSTITUTION OF CRYSTALS

Spread out the crystals in a heatproof dish or tray

Heat gently in an oven at 93°C (200°F) for 4 to 8 hours until the blue colour returns.

WARNING : Overheating crystals can reduce their capacity

10.5. EPROM - HOW TO CHANGE IT

The software which controls the AP4 resides in a memory chip called an EPROM. Software upgrades can be installed simply by replacing the EPROM. Should you be issued with a new EPROM, try to fit it yourself, or get someone to do it.

It is pretty simple really. You take one chip out, put the new one in, and that's it, finished.

We will go through it in easy stages.

Ideally you will do this indoors, on a clean table, with plenty of time. There's no rush.

Remove the chassis - see Chapter 10.2.

Disconnect the battery and pump wiring connectors from the top right hand side of the main circuit board - see Chapter 10.7.

Unscrew the pump mounting bracket from the chassis.
Put the screws and washers in a safe place.
Swing the pump out of the way without disconnecting the inlet and outlet pipes.

Look to see where the Eprom is on the TDS 9092 circuit board.

Notice which way round the chip is installed. There is a half moon depression at one end. The new chip will need to go in the same way round. But before you do that ...

It is good practice to protect EPROMs from static electricity as much as possible.

In case your fingers are charged up, discharge them by touching them onto the chassis. If you have one, wrap a conductive strap around your wrist and earth it to the chassis as shown in the diagram. If not, just touch the chassis - that should do it.

When you pull out the old EPROM, do it carefully. You may want to re-use it. The danger is that it may tip and bend the legs on the way out. To prevent this use the EPROM extractor hand tool supplied with the upgrade.

If you do not have the EPROM extractor, carefully lever-up both ends with a small screwdriver. If you do bend the legs it may be possible to straighten them again with a fine pair of pliers.

If you do not have either an EPROM extractor or a small enough screwdriver, disconnect all the cables from the main board. Remove the plastic rivets holding the main board to the chassis, and remove the main board. Now you can get the screwdriver in. Be sure to be even more careful about static.

Carefully press the old EPROM onto the antistatic foam supplied with the new EPROM.

Repeat your "earthing the fingers" routine. Touch them onto the chassis.

Right, here's the good bit. If you have an EPROM inserter, use it. If not, use your fingers - and try to avoid touching the pins.

Make sure you know which way round the chip will go.

Remove the new EPROM from its protective foam and place it gently on top of the socket.

Check that all the legs are over a hole and that none are going to get bent underneath the chip when you push it home.

Push it gently home.

That's it. You have done it!

Refit the pump.

Ensure the pump is securely screwed down - you do not want to let it shake itself loose.

Reconnect the pump and battery wiring and put everything back together again.

When you turn on the new software will automatically reboot itself and you are back in business.

CHANGING THE EPROM

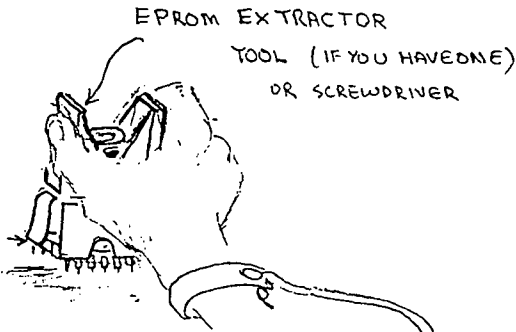
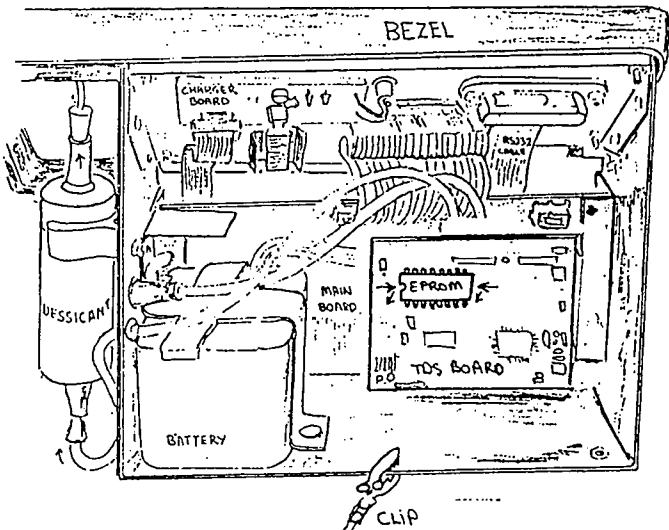
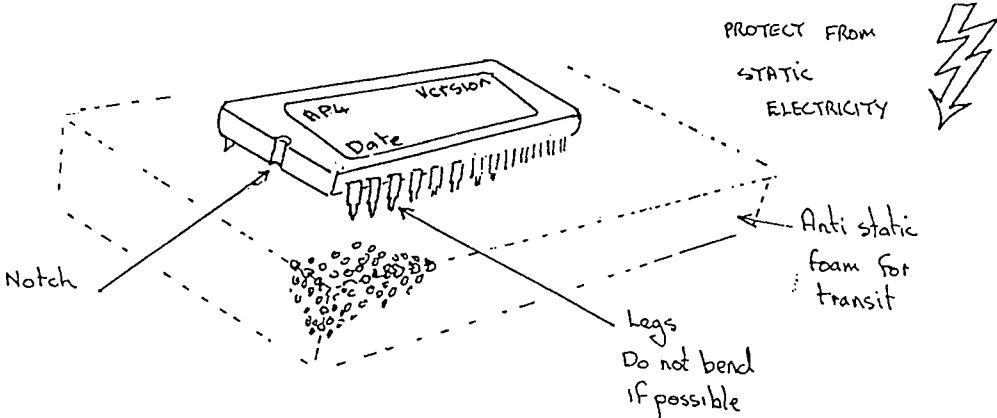

EARTH YOURSELF TO THE CASE
OR TOUCH IT FIRST

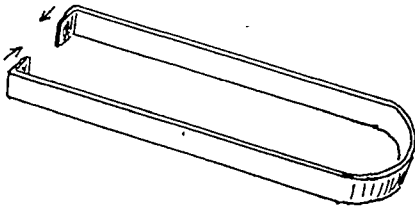

ANOTHER SORT OF
EPROM EXTRACTOR

10.6 HEAD - HOW TO DISASSEMBLE

The AP4 head circuit board contains surface mount components and is not suitable for field repairs. See Service and Guarantee, Chapter 15.

Reconfigure the head if you replace it. See chapters 10.8 & 10.10

The two halves of the head can be separated for changing or cleaning the cup seal, cup insert and gasket.

- Inspect the spring to see how it is located.
- Push out the hinge pin .
- Unplug the ribbon cable.
- Remove the spring.

Observe the light sensor calibration factor written on the inside of the light half.

You can now change the cup if you wish - Chapter 10.3.

To reassemble

- Replace the spring.
- Reconnect the ribbon cable.
- Replace the hinge pin.

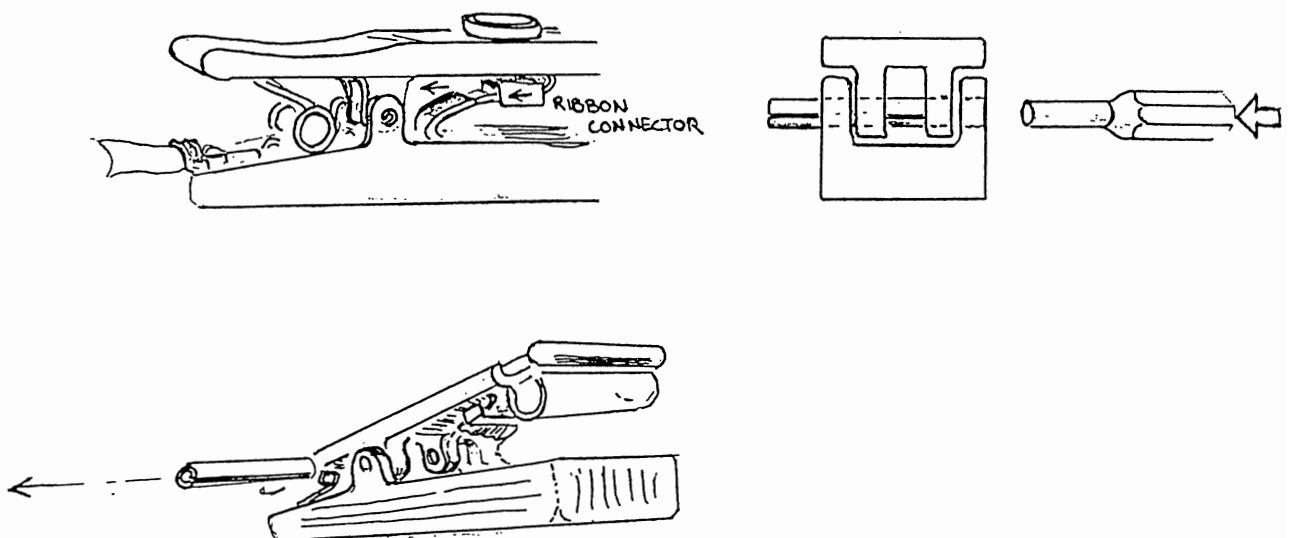

10.7 PUMP - HOW TO CHANGE IT

Remove the chassis - see Chapter 10.2

Disconnect the pump connector from the top right hand side of the main circuit board and disconnect the pump inlet and outlet pipes.

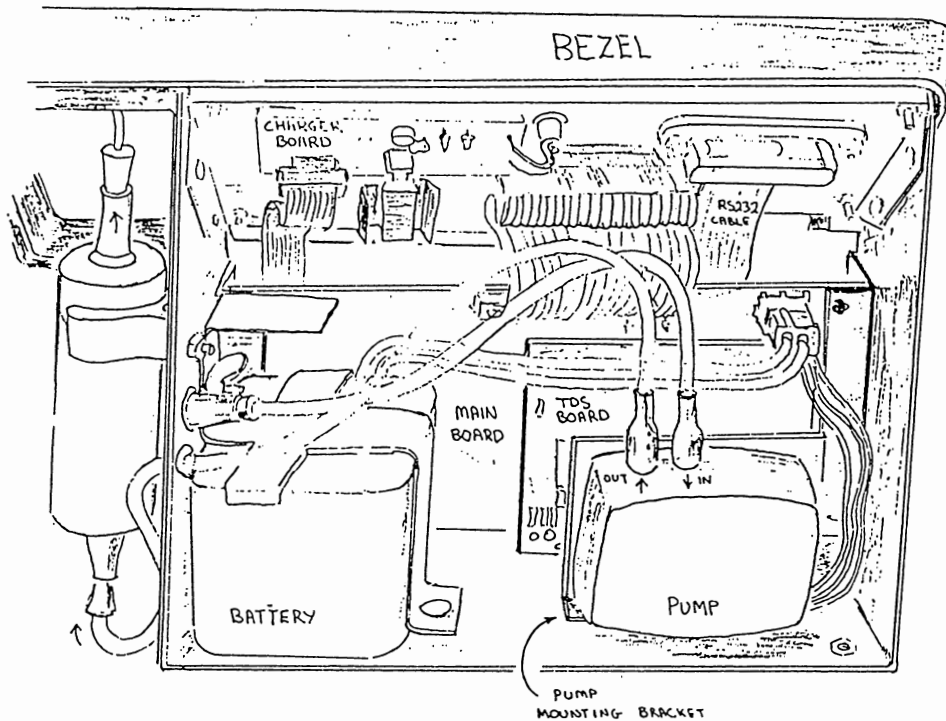

Unscrew the pump mounting bracket and remove the pump and bracket.

Unscrew the four self tapping screws to remove the pump from its bracket.

When fitting the new pump simply reverse the procedure.

It may help to moisten the pump inlet and outlets before pushing on the flexible airline tubing.

10.8 LIGHT SENSOR = CALIBRATION

Calibrating Light Measurement

The AP4 sensor head has an unfiltered GaAsP photodiode with a spectral response approximately like the ideal photo-synthetically active (PAR) response.

Its sensitivity, as measured at Delta-T, is labelled inside the sensor head, as a sensitivity factor where about 0.5 is typical. This sensitivity should be stable.

It is easy to reprogram the AP4 with a different sensitivity factor should you change sensor heads or need to re-calibrate the light sensor.

- Clean the light sensor's translucent plastic cover with a damp cloth.
- Select the "CONFIGURE AP4 HEAD" screen by pressing the <SHIFT> and <OFF> keys together.
- Use the <+> & <-> keys to either :

Set the sensor's sensitivity factor to that marked on the inside of head, (typically about 0.5)

or bring the displayed light intensity up to a known level. This will require the use of a calibrated source or a second, calibrated sensor.

10.9 RH SENSOR : CALIBRATION

- Introduction
- Setting the low RH indication
- Setting the high RH indication
- Repeat

See also page 83 on cleaning the RH sensor

Recalibration may be necessary if the RH sensor has been exposed to smoke, acid or solvent vapours or debris.

There are 2 trimmer potentiometers in the sensor head which you use for adjusting the output for low and high RH. See next page. These have received a protective coat of silicon rubber glue.

SETTING THE LOW RH INDICATION

Select READ from the main menu to display the RH. Apply a known low RH to the sensor and adjust VR2 (via the hole in the side of the sensor head, furthest from the cup) to give the correct indicated RH.

Applying a known RH is not easy. Allow plenty of time for equilibration, since so many surfaces absorb & release water.

Some methods are:

a) Blow dry, bottled gas onto the sensor. Separate the two halves of the sensor head by pushing out the hinge pin.

OR

b) Regenerate the silica gel in the AP4 and turn the pump full on for a few minutes by setting the Set RH to 5% via the READ menu.

Select START and the pump should come on.

The porometer will dry itself down as much as it can.

The indicated RH should fall to about 3% .
This is also a useful check for RH sensor damage.

OR

c) Leave the opened sensor head in a sealed polythene bag with plenty of fresh desiccant for several hours.

SETTING THE HIGH RH INDICATION

Apply a known high RH to the sensor and adjust VR1 (via the hole nearest to the cup) to give the correct indicated RH.

The RH should preferably be in the 70-80% range to give a high output, avoiding >80% RH, where the sensor output is less linear.

a) Blow air onto the sensor from a humidity generator, eg: using hydrated ferrous sulphate. Take care to avoid or compensate for temperature differences between the RH source and the porometer's RH sensor. A suitable generator is the ADC WG600 humidity generator.

OR

b) Leave the opened sensor head in a humidity-controlled chamber .

REPEAT

Repeat setting the low and high RH until the two known set points can be read to within 0.5%. At Delta-T we find two iterations are usually sufficient. More iterations will be required the further the low RH is away from 0%

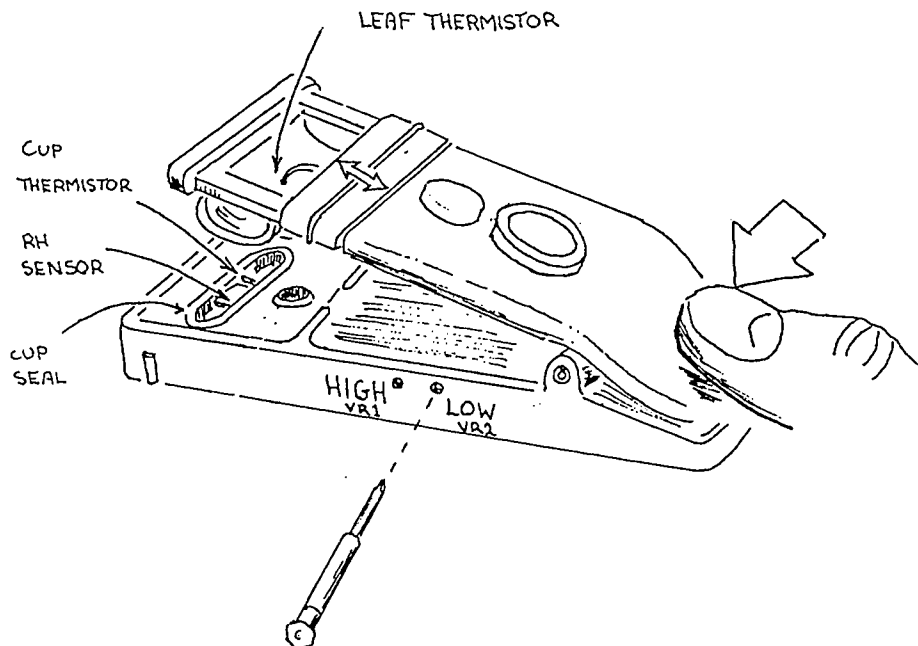

10.10 THERMISTORS = CALIBRATION

The Cup and Leaf thermistors should have a resistance of 100k Ω ($\pm 0.47\%$) at 25°C. They should maintain their accuracy, unless physically damaged.

To optimise the Cup-Leaf temperature difference accuracy, a zero reading is stored when the temperatures are equal. Subsequent readings are referred to this zero reading. Re-zeroing is necessary if you change the sensor head or if the temperature difference reading is not zero after good temperature equilibration.

To zero the temperature difference reading, select the "Configure AP4 Head" screen by pressing SHIFT and OFF keys together. On this screen is displayed the raw Cup and Leaf temperature readings, uncorrected for any systematic offset errors in the electronics.

Allow the head temperature to stabilise by placing it (with no plate or leaf) in the AP4 compartment, away from direct sunlight or sources of heat. When the displayed δT is stable, press GO.

This zero offset reading is automatically subtracted from all readings before they are displayed on all other screens (or recorded to memory).

If the displayed δT (on the SHIFT OFF screen) is more than $\pm 0.5^\circ\text{C}$, and the temperature has stabilised, then there may be a fault in one of the thermistors.

If the Cup temperature reading is obviously wrong, check that the sensor head connector is properly plugged into the main case and check the continuity of connection between the thermistor and the main circuit board. If these are OK, the cup or leaf thermistor may need replacing. See section 10.3 for how to expose the thermistor. If one of its leads is un-soldered, its resistance can be checked. It should be 100k Ω ($\pm 0.47\%$) at 25°C, falling with rising temperature. If the resistance is not correct, replace the thermistor, taking care not to over-heat it during soldering.

Similarly, if the temperature difference reading cannot be zeroed and the Cup temperature reading is OK, check the leaf thermistor's connection to the main PCB. It's resistance can be checked after disconnecting the two sensor head halves. A replacement is supplied in the spares kit, already mounted in the silicone rubber leaf pad.

WARNING

IF YOU HAVE SELECTED THIS SCREEN TO CHANGE THE LIGHT SENSOR CALIBRATION FACTOR, OR JUST TO HAVE A LOOK ROUND, OR INSPECT THE SET SCREEN, AND YOU DO NOT WISH TO CHANGE THE CURRENT TEMPERATURE OFFSET, THEN LEAVE USING EXIT INSTEAD OF GO.

10.11 SOFTWARE CRASHES : HOW TO RESET

Try resetting the AP4's computer if the keys get stuck or you cannot turn it off.

Resetting the AP4 does not, of itself, corrupt any stored readings. The display should return to the "Main Menu" screen and normal operation resume.

- Partially open the case. Remove the ribbon cable cover plate, but *do not unplug the ribbon cable*. (See 10.2)
- Remove the 4 screws on the base of the case and start to slide the chassis assembly out of the case. The ribbon cable length limits how far you can withdraw the chassis.
- Reset the AP4 by shorting together pins 4 & 6 of the digital port, the 10-way connector on the right of the main circuit board, using a screwdriver or metallic implement. (see diagram)
- Re-assemble the case.

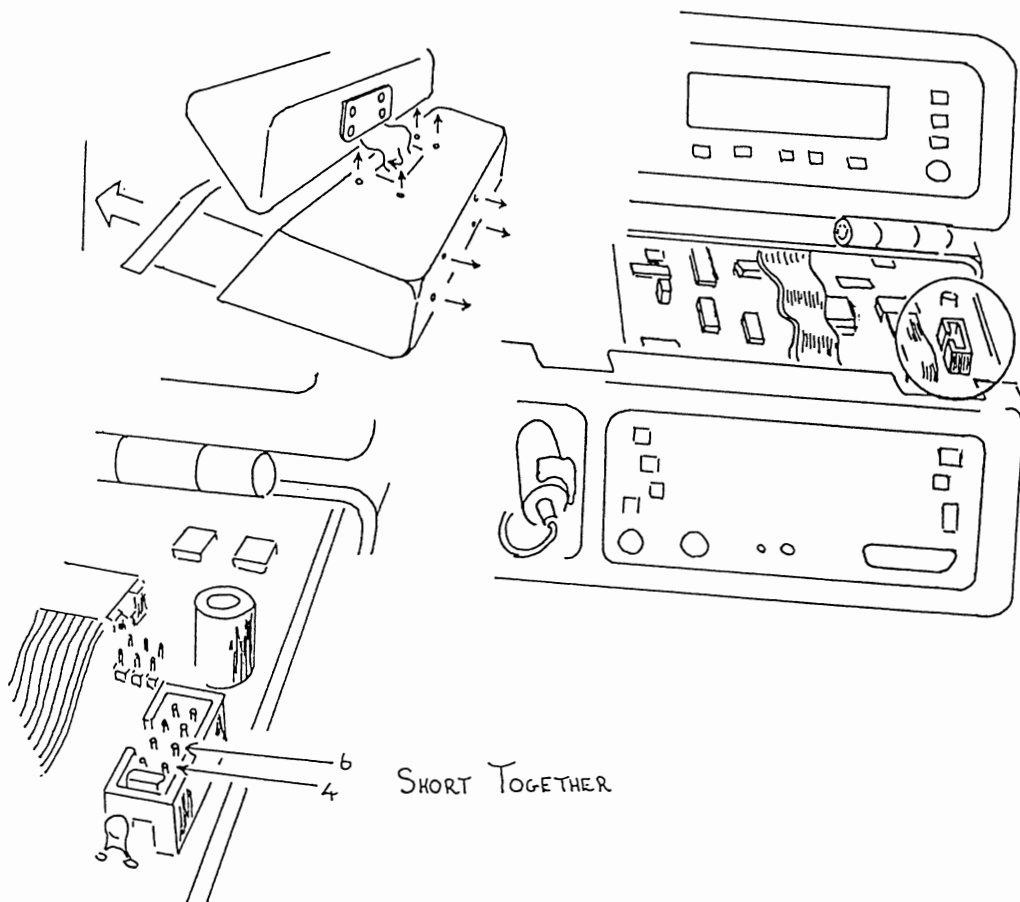

10.12 TROUBLE SHOOTING

<u>SYMPTOM</u>	<u>ie:</u>	<u>CHECK / DO:</u>	<u>REFER TO:</u>
DEAD	No display	Battery voltage, connection	10.1
STUCK	Keys have no effect	Reset the CPU	10.11
STUCK ON	Can't turn off	Reset the CPU	10.11
RESETTING	Jumps to start	Software, RS-232 connection	6.6
BATTERY PROBLEMS	Short life Can't re-charge	High current consumption Old or abused battery Keep trying, replace battery	10.3 10.1 10.1
POOR READINGS	RH Cup temperature Temp difference PAR Conductance or Resistance	Re-calibrate Clean RH sensor Check Cup thermistor Re-zero temp difference Check Leaf thermistor Clean light sensor surface Set Light Factor Reading procedure Calibration procedure Check cup seal Change to other cup size	10.9 8.1 10.10 10.10 10.10 10.8 6.3 6.4 10.3 10.3
DATA LOSS	Data or notes lost	Low battery	10.1
OUTPUT PROBLEMS	Can't communicate	Connections Parameters Handshaking	6.6 6.6 6.6
PUMP PROBLEMS	Can't lower RH	Renew desiccant Blocked air pipe Low battery Change pump	10.4 10.1 10.7

This page is blank

11. HOW IT WORKS

- WHAT HAPPENS IN THE HEAD 11.1
- HOW THE RESULTS ARE CALCULATED 11.2
 - Introduction
 - Monteith equation gives resistance from transit time
 - Wood's equation describes cup absorption
 - Diffusion coefficient depends on pressure and temperature
 - Saturated vapour pressure gradient depends on cup-leaf temperature difference
 - Transit time depends on speed of RH sensor
 - Flow chart of calibration algorithms
 - " " " measurement algorithms
- HOW THE ELECTRONICS WORK 11.3
 - Sensor head
 - Main printed circuit board
 - TDS 9092 computer card
 - Charging printed circuit board
 - Power supplies

11.1 WHAT HAPPENS IN THE HEAD

The small cup containing a relative humidity sensor is clamped to a leaf. Water vapour emitted by the leaf causes the relative humidity (RH) within the cup to rise. The instrument times how long it takes the RH to rise by a small increment, of 2.3% RH.

The leaf stomatal resistance is then automatically calculated, using the algorithms described in the next section, 11.2.

The instrument is calibrated using a calibration plate with precisely made holes of known dimensions from which the resistance has been directly calculated by finite element analysis.

The transit time is found to depend slightly on the RH history within the cup. For this reason it is necessary to repeat the readings using a consistent cycle of humidification and desiccation until the conditions in the cup have stabilised. This usually takes about 3 or 4 cycles.

The cycle is produced by a pump which blows dry air into the cup after each timing measurement. It takes the RH down about 5% RH below the set level. To minimise errors the instrument is cycled around ambient RH.

See also Appendix A : Design of the AP4

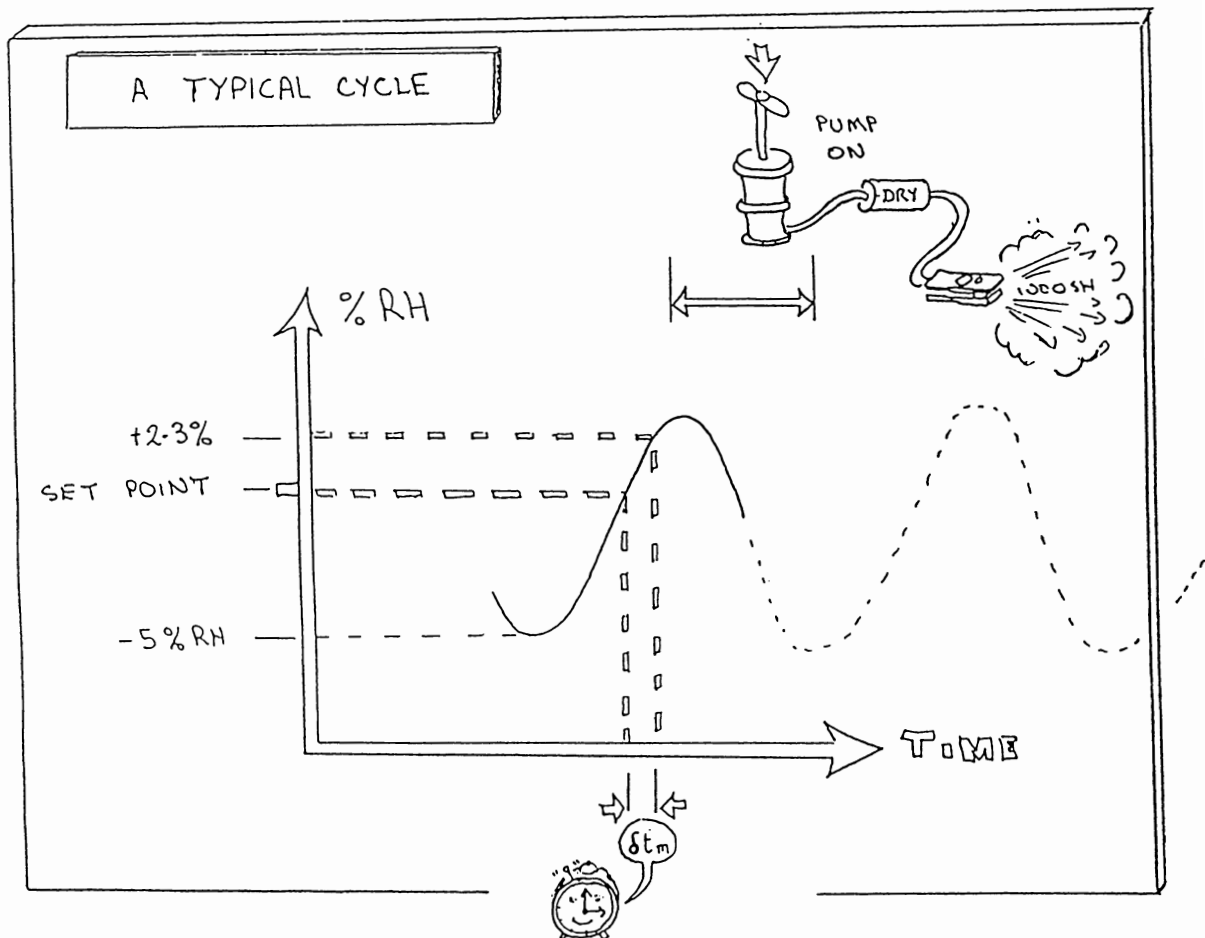

A TYPICAL CYCLE

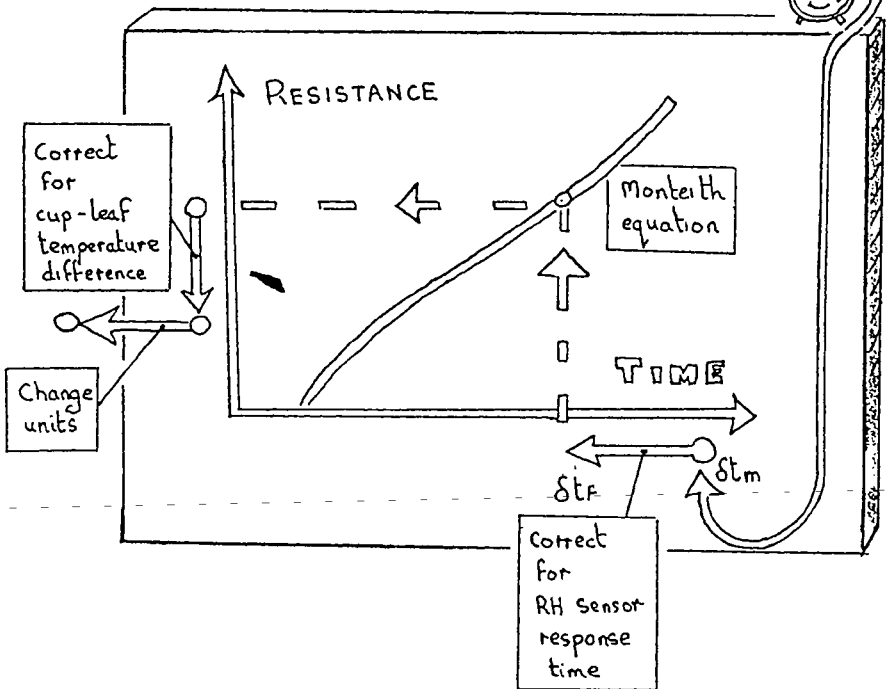
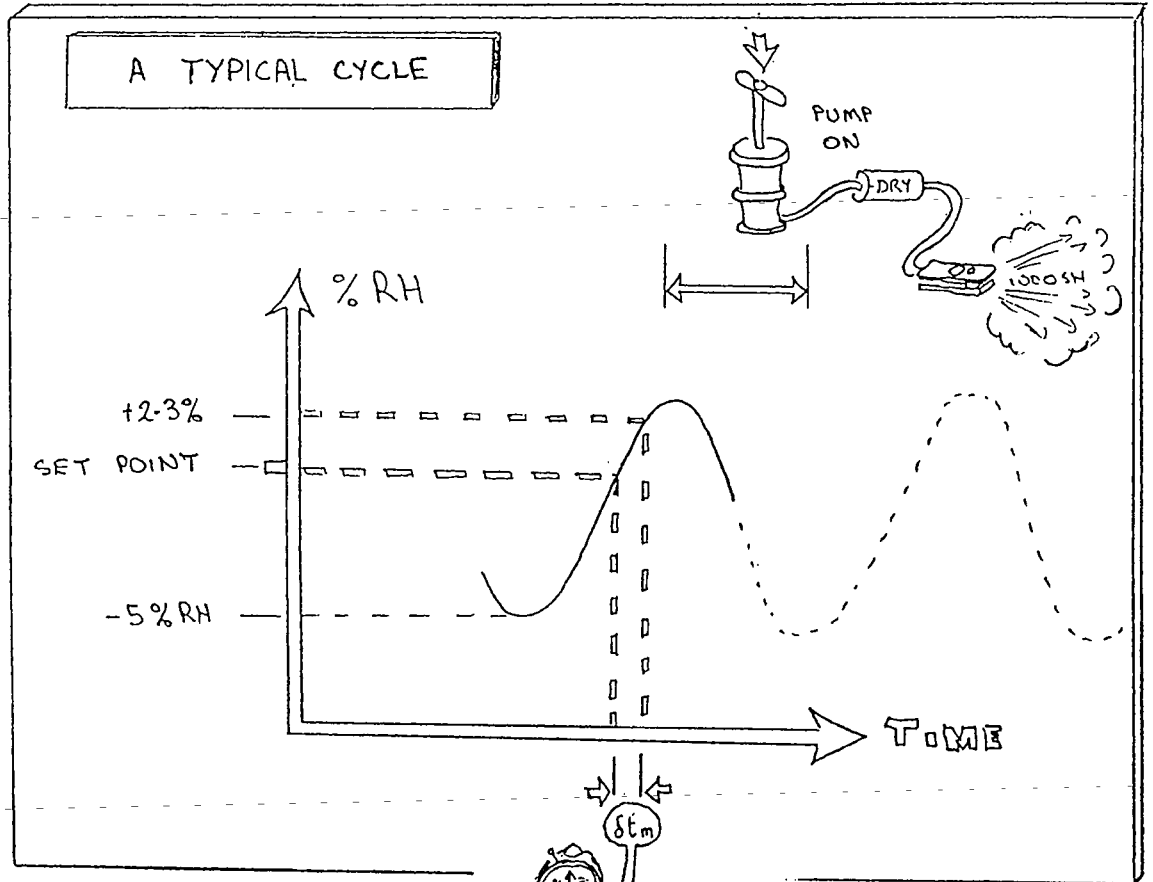

11.2 HOW THE RESULTS ARE CALCULATED

■ INTRODUCTION

■ EQUATIONS

Monteith equation gives resistance from transit time

Wood's equation describes cup absorption

Diffusion coefficient depends on pressure and temperature

Vapour pressure gradient depends on cup-leaf
temperature difference.

Transit time depends on speed of RH sensor

■ FLOW CHARTS

Calibration algorithms

Measurement algorithms

INTRODUCTION

The AP4 is similar to our previous porometers in that it uses a calibration plate with 6 sets of pores of known resistance and conductance.

In the past the calibration plate was used to create a graph from which the user could look up the resistance corresponding to a measured transit time. When there was a shift in temperature the operator was encouraged to either recalibrate or apply a number of corrections. With hindsight these corrections now appear to have been too simple. It was also apparent that frequent recalibration in the field, with its laborious manual redrawing of graphs, was tedious and time consuming. Our main brief for the design of the AP4 was to circumvent this with the use of a microprocessor. In fact we have gone beyond this, and the porometer now contains a theoretical model of its own behaviour, based on the gas diffusion laws. It is now able to compensate quite well for any temperature shifts, and is quick and easy to recalibrate.

This has been made possible as a result of the work of Monteith, Campbell and Potter (1988) and Wood (unpublished and summarised here in Appendix A and B).

Monteith *et al* applied gas diffusion theory to derive an equation for resistance in terms of the transit time. Their theoretical model took account of the finite response time of the humidity sensor, the absorption of water vapour by the cup walls and sensor, and the difference between the leaf and cup temperatures. They found that the theory described quite well the sensitivity and the temperature coefficients of the Delta-T Mark 3 cycling porometer.

Wood has made substantial additional contributions to the theory of cycling porometry. He has extended the Monteith theory so that it can be implemented in the AP4. He has also modelled the dynamic behaviour of the porometer cup, using two-dimensional finite element analysis. This has improved our understanding of the dynamic behaviour of the vapour pressure gradient which drives the water vapour across the cup, and given us a physical insight into the shape of the resistance versus transit-time graph. He has also refined the calculation of calibration plate values using three-dimensional finite element analysis.

Wood extended the Monteith theory by investigating and characterising the temperature dependence of the absorption of water vapour in the cup, and also the behaviour of the RH sensor. He has integrated these, and other temperature dependent variables, with the Monteith equation. The resulting set of algorithms can be used to accurately measure resistance over an extended range well away from the calibration temperature.

Wood's method still requires the use of the calibration plate. With earlier cycling porometers the calibration plate was used to manually construct a graph of transit time versus resistance. The resistance of an unknown leaf was then manually read off. Now the calibration plate is used to characterise the water absorption by each individual cup, which is then substituted in the Monteith equation to automatically calculate the resistance.

Readings are now valid for modest excursions away from the ambient temperature existing at calibration. These corrections maintain the accuracy of readings to within $\pm 20\%$ for temperature variations of $+10^{\circ}\text{C}$ and -5°C away from calibration. *This means you do not have to recalibrate so often as with earlier porometers.*

Cycling porometry has been well established as an experimentally validated technique for many years, and our instruments have a good reputation in the international scientific community. The development of the AP4 represents a profound improvement in the theoretical credibility of cycling porometry and the use of calibration plates, as an alternative to the steady state method.

The next section describes the equations used in the theoretical model of the porometer:-

- Monteith *et al* equations for resistance as a function of transit time.
- Wood's equations for cup absorption.
- Temperature and pressure dependence of the diffusion coefficient of water vapour, and its effect on resistance.
- Temperature dependence of saturated vapour pressure.
- Vapour pressure gradient dependence on cup-leaf temperature difference.
- RH and transit time dependence of the RH sensor response time.

It is followed by flow diagrams showing the order in which the various equations are used when calibrating and when reading.

See also : Appendix B - Test Results, which experimentally validate these algorithms

THE MONTEITH ET AL EQUATION FOR TRANSIT TIME

If the time constant associated with the RH sensor is ignored, then the dynamic behaviour of the cup can be modelled as follows:-

From Monteith's equations 8a and 17 (Monteith et al, 1988)

$$\delta t = \frac{\delta\phi}{(1-\phi)} \left[\frac{4 (L+L')^2 + r(L+L')}{\pi^2 D} \right] \dots\dots\dots(1)$$

- where δt = transit time
- D = diffusion coefficient of water vapour in air
- r = resistance of the leaf
- L = cup length
- L' = a notional extra cup length to account for moisture absorption in the cup.
- ϕ = relative humidity
- $\delta\phi$ = the small increase in relative humidity in time δt

THE MONTEITH ET AL EQUATION FOR RESISTANCE

We can reorganise the above equation to express the resistance r in terms of the transit time δt .

$$r_{leaf} = \frac{\delta t (1-\phi)}{(L+L') \delta\phi} - \frac{4 (L + L')}{\pi^2 D} \dots\dots\dots(2)$$

- L is known - 7mm
- ϕ is set - the RH set point about which the porometer cycles
- $\delta\phi$ is set at 2.3%RH
- D is known, see below for an equation
- δt is measured directly by the AP4

The only unknown is the term L' , which represents the amount of water vapour absorbed directly by the cup walls (expressed as an extra cup length).

We determine this, the wall absorption, by calibrating each porometer head with the calibration plate, and then doing a least squares fit, as described below.

A Minor Refinement to the Monteith Equations

The above two equations contain the factor:-

$$\frac{\delta\phi}{(1-\phi)} = \frac{0.023}{(1-\phi)}$$

This factor is in fact an approximation, and a better value is given by replacing

$$\frac{\delta\phi}{(1-\phi)} \quad \text{by} \quad \ln \left[\frac{1-\phi}{1-\phi-\delta\phi} \right] \dots\dots\dots (3)$$

where ln denotes logarithm to the base e

WOOD'S EQUATION FOR CUP ABSORPTION

At Delta-T John Wood has experimentally determined what variables affect Monteith's cup length parameter L' associated with water absorption within the cup. A summary of these experiments, validating the algorithms, is given in Appendix B.

Wood also investigated the performance of a dynamic model of a cup using a 2-dimensional finite element analysis. This gave useful and complementary insights into the effects of slow sensor time constants on the curvature of the resistance versus transit time curve. It also helped in the redesign of the cup, and is summarised in Appendix A.

These investigations showed that L' depends both on the cup temperature and the transit time as follows:-

$$L' = b(0) \cdot \exp(-0.009T_{cup}) \cdot (\delta t_f)^{b(1)} \cdot \exp\{b(2)[\ln(\delta t_f)]^2\} \dots(4)$$

where T_{cup} = cup temperature ($^{\circ}\text{C}$)

δt_f = corrected transit time - see below

and where $b(0)$, $b(1)$ and $b(2)$ are constants characteristic of each head. They are determined at calibration time as follows.

Wood's equation is used both when calibrating and when taking a reading. When calibrating, L' is calculated for all 6 plate positions from the corrected transit times δt_f by rearranging Monteith's equation for L' . The resistance values used are the theoretical (true) plate resistances calculated for the known physical dimensions of the calibration plate pores, at the known cup temperature with compensation for the measured cup-leaf temperature difference δT .

The AP4 then determines the constants $b(0)$, $b(1)$ and $b(2)$ using least squares best fit on a log-log version of equation (4).

When taking a measurement Wood's equation is used to predict the cup absorption L' for a measured transit time and cup temperature. This is substituted in Monteith's equation (2) to obtain a resistance. This resistance is then corrected to that for an isothermal cup ($\delta T=0$). Finally the resistance is converted to the units required by the user.

TEMPERATURE AND PRESSURE CORRECTION FOR THE DIFFUSION COEFFICIENT OF WATER VAPOUR IN AIR :-

The diffusion coefficient of water vapour in air varies with temperature as follows :

T °C	0	5	10	15	20	25	30	35	40	45	50
D cm ² s ⁻¹	0.212	0.220	0.227	0.234	0.242	0.249	0.257	0.264	0.272	0.280	0.287

(reference Campbell 1977)

The temperature and pressure dependence can be written :

$$D = D_0 \left[\frac{T+273}{T_0+273} \right]^{1.75} \frac{P_0}{P} \quad \text{(Parkinson, 1985)(5)}$$

where D_0 is the diffusion coefficient at temperature T_0 and pressure P_0 and D is the value at T and P

Over the range -5 to $+55^\circ\text{C}$ the following linear approximation is adequate and is used in the AP4 :

$$D = \frac{(0.212 + 0.0015 T) \times 1000}{P} \quad \text{.....(6)}$$

where T is in $^\circ\text{C}$ and P is in hPa (or mbar).

We use equation (6) within the AP4. In chapter 8.2, in the tutorial on the temperature and pressure dependence of molar velocity units, we refer to equation (5).

RESISTANCE DEPENDENCE ON DIFFUSION COEFFICIENT

From Fick's law Flux \propto D x concentration gradient

one can derive the following relationship by integrating with respect to distance

$$\text{Flux} \propto \frac{\text{concentration difference}}{\text{resistance}}$$

In other words the resistance is inversely proportional to the the diffusion coefficient D integrated over the whole volume of the chamber.

This is explained in a number of standard textbooks on environmental physics, see for instance Monteith & Unsworth (1990)

The resistance of the calibration plate is calculated at 20°C at an atmospheric pressure of 1000 hPa (mbar) from the known geometry of the pores.

The resistance at other temperatures is given by :-

$$r(T) = \frac{r(20^\circ\text{C}) \cdot D(20^\circ\text{C})}{D(T)}$$

Combining this with equation (6)

$$r(T_{\text{cup}}) = \frac{r(20^\circ\text{C}) \times 0.242 \times P}{(0.212 + 0.0015 T_{\text{cup}}) 1000} \dots\dots\dots(7)$$

where T_{cup} is in °C
and P is atmospheric pressure (in hPa or mbar)
and $r(T)$ is the cup resistance at temperature T in velocity units.

This equation can be used to convert measured resistance values to other temperatures and pressures.

The porometer always gives you the answer at the cup temperature and set atmospheric pressure.

See also chapter 8.2 : resistance and conductance units.

SATURATED VAPOUR PRESSURE DEPENDENCE ON TEMPERATURE

In calculating resistance it is assumed that the water vapour in the leaf, or calibration plate, is at the saturated vapour pressure. As pointed out by Monteith, as reproduced in chapter 8.4, this assumption is valid for many practical purposes.

Tables of water vapour pressure as a function of temperature are available elsewhere (List RJ 1971 Smithsonian Meteorological Tables, 6th ed. Washington DC, Smithsonian Institution Press.)

The porometer uses the following approximation, from Campbell (1977)

$$\text{SVP}(T) = 10.26 \exp [52.57 - 6790/(273+T) - 5.03 \ln(273+T)] \dots(8)$$

where T is in °C
and SVP is in hPa (or mbar)

VAPOUR PRESSURE GRADIENT CORRECTIONS DUE TO CUP-LEAF TEMPERATURE DIFFERENCE

The vapour pressure gradient is the appropriate driving force to use when the leaf, or plate, and the cup are not at the same temperature.

$$\text{That is Flux } E = (P_1 - P_2) / r \times C$$

where $P_1 - P_2$ is the vapour pressure difference,
the resistance $r = r_{\text{cup}} + r_{\text{leaf}}$
and C is a constant of proportionality.

P_1 is taken as the saturated vapour pressure of water vapour in air at T_{leaf} .

$$\text{Also } P_2 = \phi \times \text{SVP}(T_{\text{cup}})$$

where ϕ is the relative humidity in the porometer cup.

So the flow by diffusion of water vapour into the cup depends on the vapour pressure difference divided by the resistance. If the leaf is cooler than the cup, the porometer will record the same transit time as from another leaf of higher resistance at the same temperature as the cup.

We can therefore set up the following simultaneous equations:

$$E/C \quad \square \quad \frac{[\text{SVP}(T_{\text{leaf}}) - \phi \times \text{SVP}(T_{\text{cup}})]}{[r_{\text{leaf}, \delta T = 0} + r_{\text{cup}}]}$$

and

$$E/C \quad = \quad \frac{[\text{SVP}(T_{\text{cup}}) - \phi \times \text{SVP}(T_{\text{cup}})]}{[r_{\text{leaf}, \delta T \neq 0} + r_{\text{cup}}]}$$

These can be rearranged and solved together to convert between measured resistances and what the resistance would be if $\delta T = 0$.

Measured resistances are always adjusted and quoted to be that which would be measured at isothermal conditions.

Case 1 : Using Calibration Plate, ie Resistance Known.

When calibrating, we know the resistance of the calibration plate for $\delta T = 0$. The resistance the porometer detects for any given δT can be found by rearranging the above equations to give :

$$r_{plate, \delta T \neq 0} = (r_{ref} + r_{cup}) \left[\frac{SVP(T_{cup}) - \phi * SVP(T_{cup})}{SVP(T_{plate}) - \phi * SVP(T_{cup})} \right] - r_{cup} \dots(9)$$

where r_{ref} = known (theoretical or 'true') reference calibration plate resistance at cup temperature assuming no temperature gradient

r_{cup} = resistance of the porometer cup

Case 2 : Measuring a leaf, ie Resistance unknown

If the porometer is measuring a particular unknown resistance, at a measured δT , then the resistance it would measure assuming no temperature gradient is given by

$$r_{corrected} = (r_{measured} + r_{cup}) \left[\frac{SVP(T_{leaf}) - \phi * SVP(T_{cup})}{SVP(T_{cup}) - \phi * SVP(T_{cup})} \right] - r_{cup} \dots(10)$$

(Footnote : Historically we have called this the δT correction)

CUP RESISTANCE

In both cases above the cup resistance is given by

$$r_{cup} = \frac{4 (L+L')}{\pi^2 D(T)} \dots\dots\dots(11)$$

This is derived in Monteith *et al*, (1988)

CORRECTION FOR THE RH SENSOR TIME CONSTANT (τ)

The response time τ_s of the RH sensor is finite, and is temperature dependent.

$$\tau_s = 2.5 \exp(-0.0723 T)$$

where T is in °C

(This equation was derived from information supplied by the manufacturer Vaisala.)

We have determined an equation which corrects the transit time for the finite response time of the RH sensor:-

$$\delta t_f = \delta t_m \left[\frac{1 - 1.5 (1-\phi)^2}{(1-\phi-0.023)^2} \exp - \left[\frac{\delta t_m}{155 * \tau_s} \right]^{0.7} \right] \dots (12)$$

where δt_f = corrected transit time -
that would be seen by a perfectly fast sensor
 δt_m = measured transit time
 τ_s = RH sensor time constant at temperature T
 ϕ = RH cycling level - the "Set RH" point
0.023 = RH rise over which the transit is timed.

This equation was derived semi-empirically assuming that the relative humidity during a cycle is driven 5% below the RH set point, and there is no overshoot in the drying down portion of the cycle. Further explanation is given below.

We find that this equation works well over the range of conditions we encounter in practice.

The sensor response time can account for up to half the actual transit time in some conditions.

DERIVATION OF RH SENSOR TIME CONSTANT CORRECTIONS

Schematic graph showing the true and measured RH in the cup.

The difference between the two curves is due to the finite response time of the RH sensor.

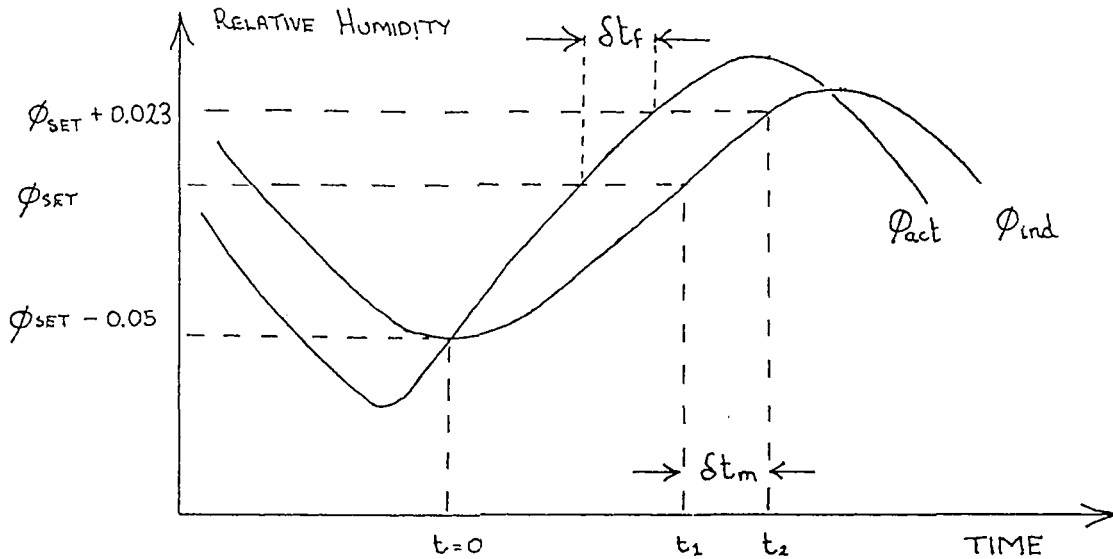

Definitions

- ϕ_{ind} = RH indicated by sensor
- ϕ_{act} = actual RH at the sensor
- δt_m = transit time measured by sensor
(from RH set point ϕ_{set} to $\phi_{set} + 2.3\%$)
- δt_f = corrected transit time
that would be seen by a perfectly fast sensor
- τ_s = time constant of RH sensor
- τ = time constant of RH rise in the cup
- t = time

Assume that the indicated minimum RH is controlled to $\phi_{set}-0.05$, and that $t = 0$ when ϕ_{ind} is a minimum. Also that the actual RH in the cup follows an exponential curve.

then $\phi_{act} = 1 - A \exp(-t/\tau)$

Setting $t = 0$ when $\phi = \phi_{set} - 0.05$
it can be shown that $A = 1 - (\phi_{set}-0.05)$

Similarly, setting $t = t_a$ when $\phi = \phi_{set}$
and $t = t_b$ when $\phi = \phi_{set}+0.023$
and defining $\delta t_f = t_a-t_b$

then it can be shown that $\delta t_f = \tau \ln(\text{RHfactor}) \dots\dots\dots(13)$

where $\text{RHfactor} = \frac{1-\phi_{set}}{1-(\phi_{set}+0.023)}$

ϕ_{ind} is described by the differential equation :

$$\frac{d\phi_{ind}}{dt} = \frac{\phi_{act} - \phi_{ind}}{\tau_s} = \frac{1 - A \exp(-t/\tau) - \phi_{ind}}{\tau_s}$$

This gives $\phi_{ind} = 1 - \left[\frac{\tau A \exp(-t/\tau)}{\tau - \tau_s} - \frac{\tau_s A \exp(-t/\tau_s)}{\tau - \tau_s} \right]$

Thus $\frac{1 - \phi_{ind}}{A} = \frac{\tau \exp(-t/\tau)}{\tau - \tau_s} - \frac{\tau_s \exp(-t/\tau_s)}{\tau - \tau_s}$

At $t = t_1$; $\frac{1 - \phi_{set}}{A} = \frac{\tau \exp(-t_1/\tau)}{\tau - \tau_s} - \frac{\tau_s \exp(-t_1/\tau_s)}{\tau - \tau_s} \dots(14)$

At $t = t_2$;

$$\frac{1 - (\phi_{set} + 0.023)}{A} = \frac{\tau \exp(-t_2/\tau)}{\tau - \tau_s} - \frac{\tau_s \exp(-t_2/\tau_s)}{\tau - \tau_s} \dots(15)$$

Let us define $\delta t_m = t_2 - t_1$

Equations 14 and 15 were solved iteratively (using the Newton Raphson method) for t_1 and t_2 for values of τ , τ_s , ϕ_{set} covering the range of AP4 operating conditions, and $\delta t_m(t_2 - t_1)$ compared with δt_f .

An empirical relationship was then found which predicted δt_f from δt_m with errors less than ± 10 ms over the whole range.

This is the RH sensor time constant correction - equation (12) :-

$$\delta t_f = \delta t_m \left[\frac{1 - 1.5 (1 - \phi)^2}{(1 - \phi - 0.023)^2} \exp - \left[\frac{\delta t_m}{155 * \tau_s} \right]^{0.7} \right]$$

A graph of the correction for $\phi_{set} = 0.5$; $\tau_s = 0.4$ s (at 25°C) is given below.

GRAPH OF A TYPICAL TRANSIT TIME CORRECTION

Transit time correction

at RH 50% 25°C

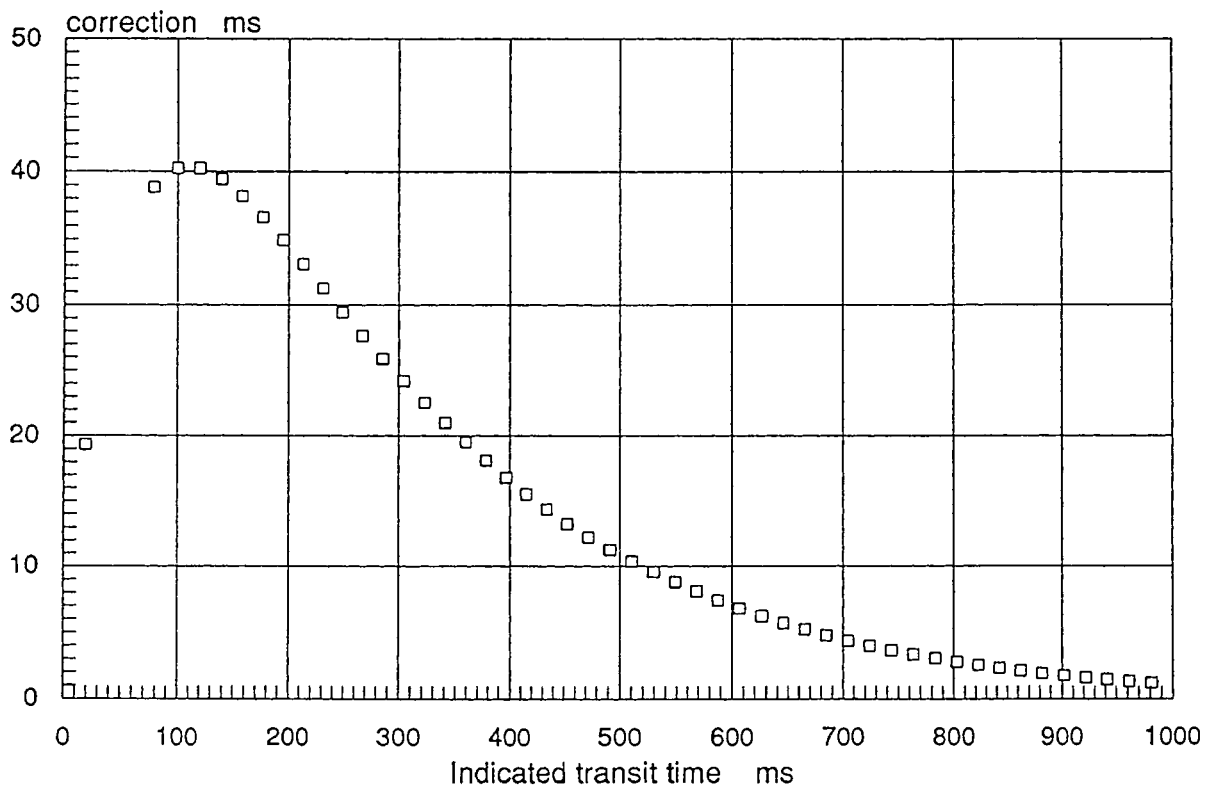

How the results are calculated

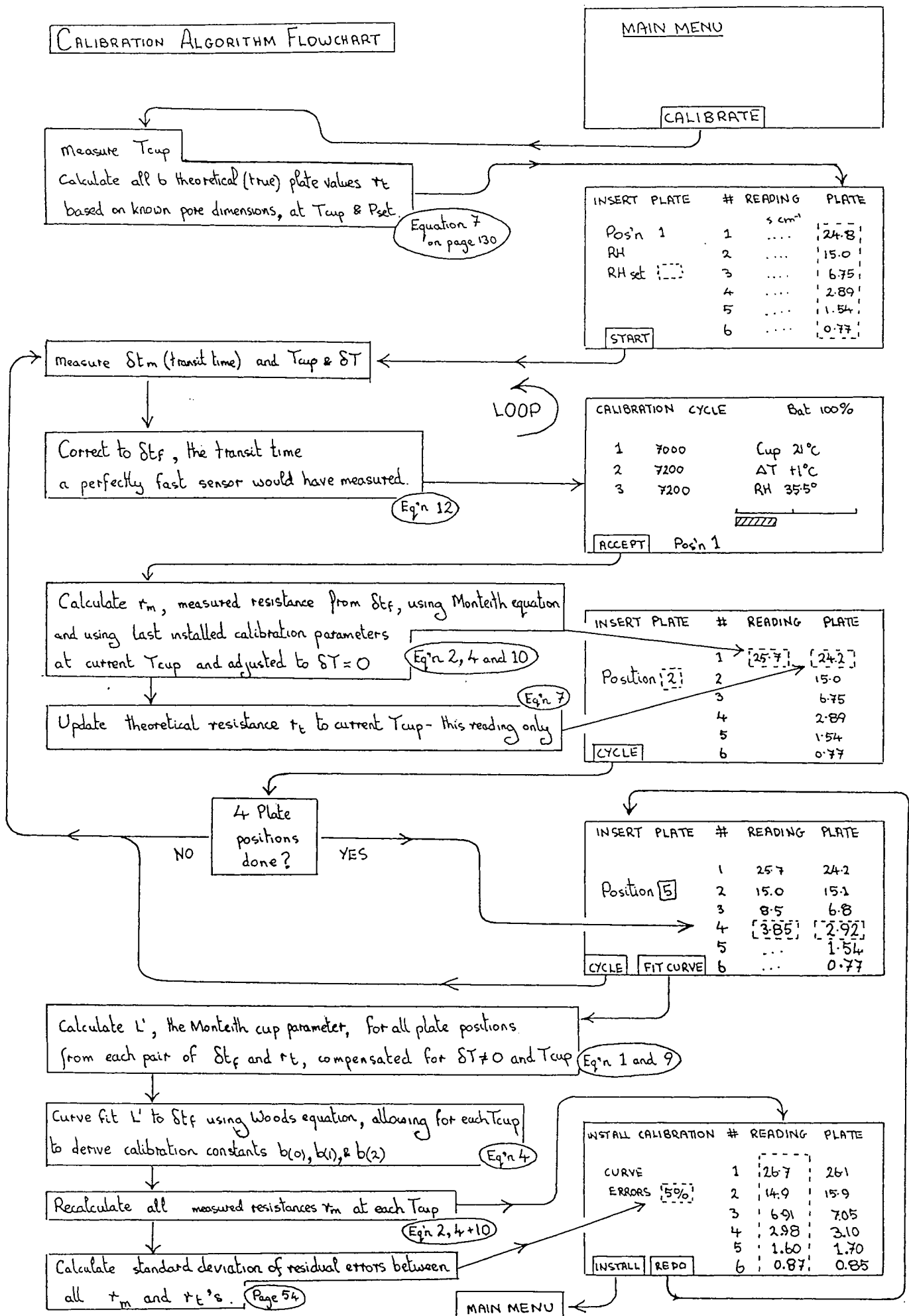

MEASUREMENT ALGORITHMS FLOWCHART

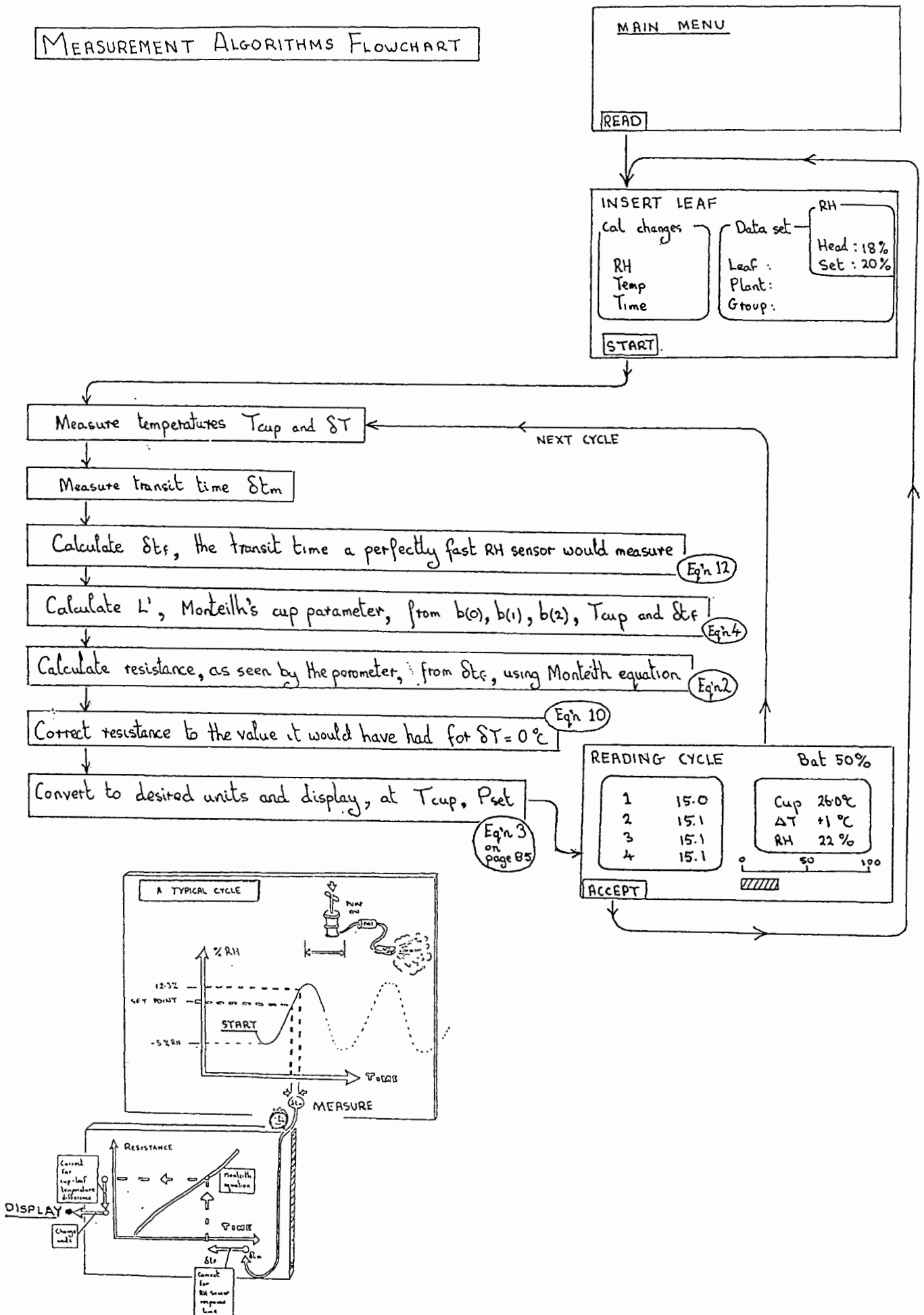

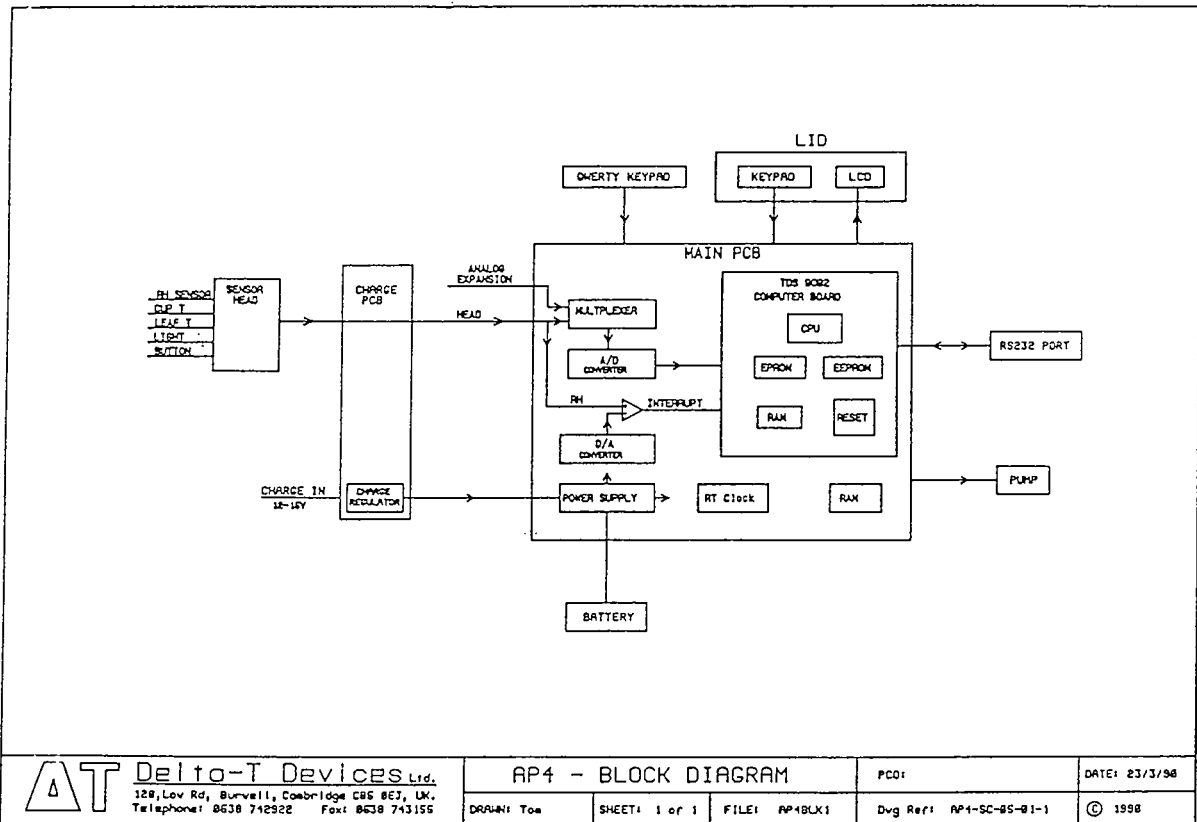

11.3 HOW THE ELECTRONICS WORK

The AP4 is at least an order of magnitude more sophisticated than previous porometers. The sensor head contains surface mount technology and the case contains a microprocessor.

This section gives a broad overview of how the electronics hardware works.

It does not explain how to do repairs.

Only experienced electronics specialists will find it useful.

- Sensor head
- Main printed circuit board
- TDS 9092 microprocessor board
- Charging printed circuit board
- Power supplies
- Power rails

See also Trouble shooting table, Chapter 10.12, also on the laminated plastic Quick Guide.

See also Circuit Diagrams, Chapter 12.

SENSOR HEAD

The Relative Humidity sensor capacitor is excited by a 1.2MHz, 0 to 2.5 Volt square-wave from IC2. The diode ring, D1, gives a voltage via the filter, R1/C2, proportional to the difference in capacitance between C3 and the RH sensor. The Op-amp, IC1 scales this to 0-2.5V for 0-100% RH, with adjustment for 0% RH by VR2 and gain by VR1.

The cup & leaf thermistors (100k Ω at 25°C), together with R9, R10, provide temperature-dependent voltage outputs.

The Photosynthetically Active Radiation sensor, a photo-diode, emits a current proportional to the incident PAR. A calibration factor for the individual sensor is held in software and needs changing if the sensor head is changed (see Chapter 10.8).

MAIN PRINTED CIRCUIT BOARD

Analogue signals from the sensor head are conditioned to voltages in range 0 to 2.5V range. Extra signals are derived for:

Change in RH	by differentiator;	IC3b.
Temperature difference	by differential amplifier,	IC4a,b,d.
Battery voltage	by potential divider,	R17,18.

The signals are selected by the multiplexer, IC6 and then measured by the 10 bit A/D converter, IC5.

A spare input channel (Multiplexer address 6), together with power supplies and a spare digital i/o port are available on the analogue expansion port. (See connector pinouts)

The transit time for the RH to rise between set values is measured by comparing the filtered RH voltage with the D/A converter (IC9) output. When the RH voltage reaches the D/A voltage, the comparator, IC3b, interrupts the TDS9092 microprocessor, starting or stopping a timer.

In the digital section, most components are providing extensions to the TDS9092 computer card. The RAM chip, IC12, provides memory for the readings & notes. It is powered from the "+3V" power rail, originating from IC13, that remains powered up when the AP4 is off. The Real Time Clock, IC14, is also powered from "+3V" and adjusted by VC1.

TDS 9092 MICROPROCESSOR CARD

This miniature computer card contains a 6303 CPU, a large Gate Array, workspace RAM, RS232 port, EEPROM (storing calibration factors etc.) and the AP4 software in EPROM. The gate array contains a watch-dog timer that resets the CPU if a program crash occurs.

The MAX666's Low Battery Output resets the CPU if the BAT+ voltage falls below 5.8 Volts.

Pressing the square button in the corner of the TDS board or connecting together pins 4 & 6 of the Digital Port also resets the system.

RS-232 ($\pm 9V$) serial outputs and inputs are provided for sending stored readings to a computer or printer. Handshake input & output signals are available, if necessary, and are connected to appropriate pins on the 25-way D connector by jumpers, J3 & J4. (see Chapter 6.6)

The TDS9092 connector pins are each numbered with a lower case letter and a number. (eg: a12, not to be confused with A12, Address bit 12)

CHARGING PRINTED CIRCUIT BOARD

This small PCB has a LM317 regulator, IC1, to stabilise the Charge input Voltage to 10.1 Volts at the point marked "Vreg."

WARNING : *This voltage is set by VR1, "V ADJ", and must not be set too high, otherwise battery over-charging may release explosive hydrogen/oxygen mixtures.*

POWER SUPPLIES

The re-chargeable Lead-Acid battery is the AP4's only source of power. It is connected via a re-settable thermal fuse, FS1. If this is hot, there is a short-circuit somewhere. The battery current can be measured by replacing the jumper P1, P2 (digital port, pins 1 & 2) with an ammeter. When the pump comes full on, this current rises to over 1 A, and to measure this the meter impedance must be less than 1Ω.

The AP4 is turned OFF by the control signal, "ShutDown" being pulled high by R20, cutting off all power except the "+3V" rail via IC13.

The "ON" button pulls "SHDN" low, activating the other power rails by turning on TR2 and enabling IC11 and the MAX666 on the TDS9092. Port P52 should then go high, under software control, turning on TR3, holding "SHDN" low until the AP4 switches off.

The AP4 can also be switched on at a programmed time by IC14, via TR6.

POWER RAILS

NAME	SOURCE	DESCRIPTION	VOLTAGE Limits	CURRENT Typical	CONDITIONS
PUMP+	Battery	AP4 Power	7.6 - 8.4	50 mA	AP4 On, Pump Off
		Via fuse	7.4 - 8.4	0.5 A	Pump On Full
		(I measured @ P1/P2)	4 - 8.4	20 μA	AP4 Off
			7.6 - 9.4	-0.5 A max	Charger On
+5V	TDS9092	To digital ICs.	4.75 - 5.25	10 mA	AP4 On
+5VAN	IC11	To analog ICs.	4.75 - 5.25	5 mA	AP4 On
BAT+	Battery	filtered	7.1 - 8.4	30 mA	AP4 On
SW BAT+	Battery	Switched BAT	7.6 - 8.4	5 mA	AP4 On
+3V	IC13	To RAM, RTC.	4.5 - 5.0	40 μA	AP4 On
			2.7 - 3.0	20 μA	AP4 Off.
VEE	IC10	To LCD	-6 - -11V	2 mA	AP4 On, Set by LCD Control

12 . CIRCUIT DIAGRAMS

- Analogue
- Digital
- TDS9090 Forth Computer
- Charge PCB
- Main PCB
- Block Diagram
- Head Circuit

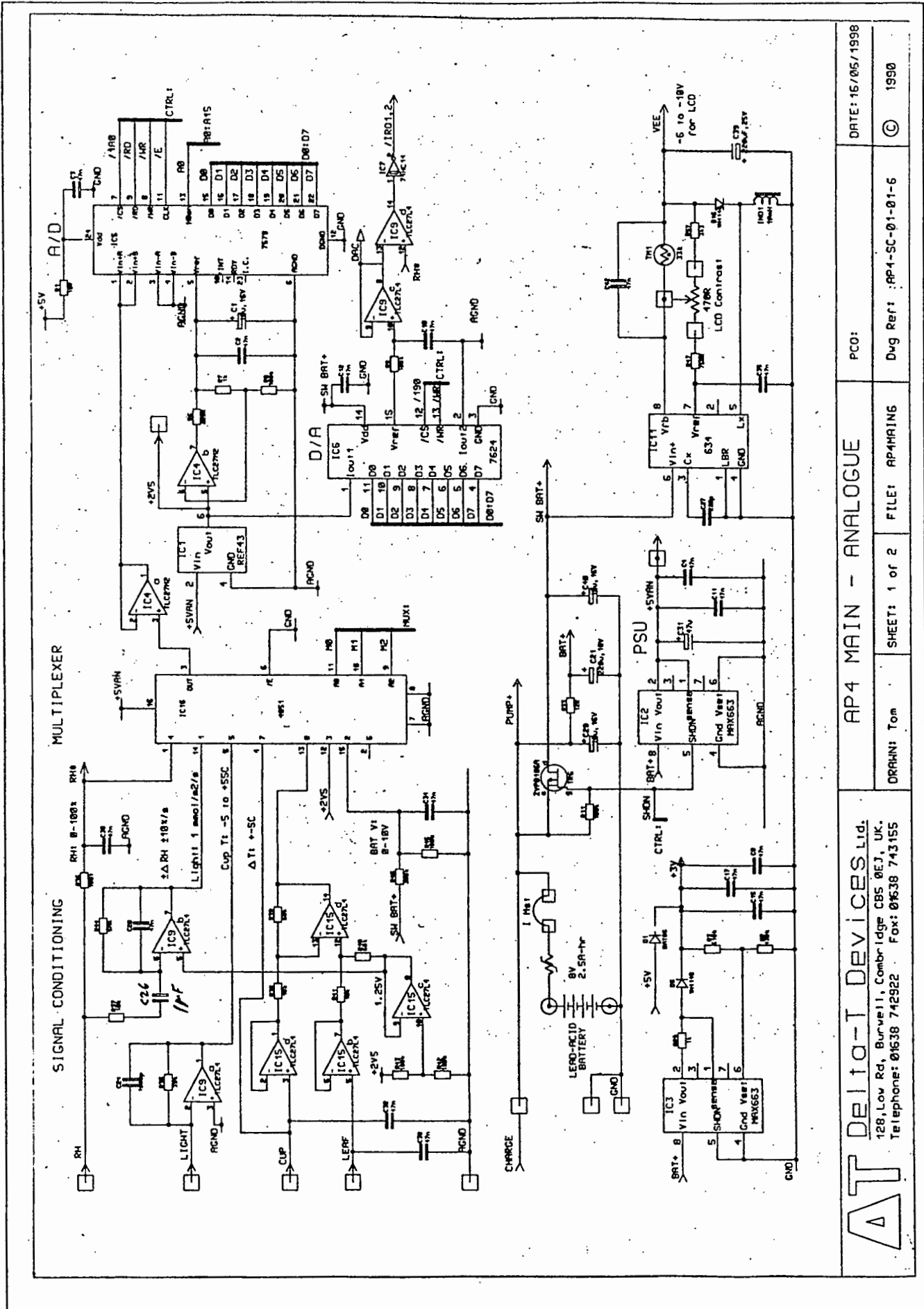

 AT	DELTA-T DEVICES Ltd. 128, Low Rd, Burwell, Cambridge CB5 0EJ, UK. Telephone: 01638 742922 Fax: 01638 743155		AP4 MAIN - ANALOGUE	PCO:	DATE: 16/05/1998
	DRAWN: Tom	SHEET: 1 of 2	FILE: AP4MAIN	Dwg Ref: AP4-SC-01-01-6	© 1990

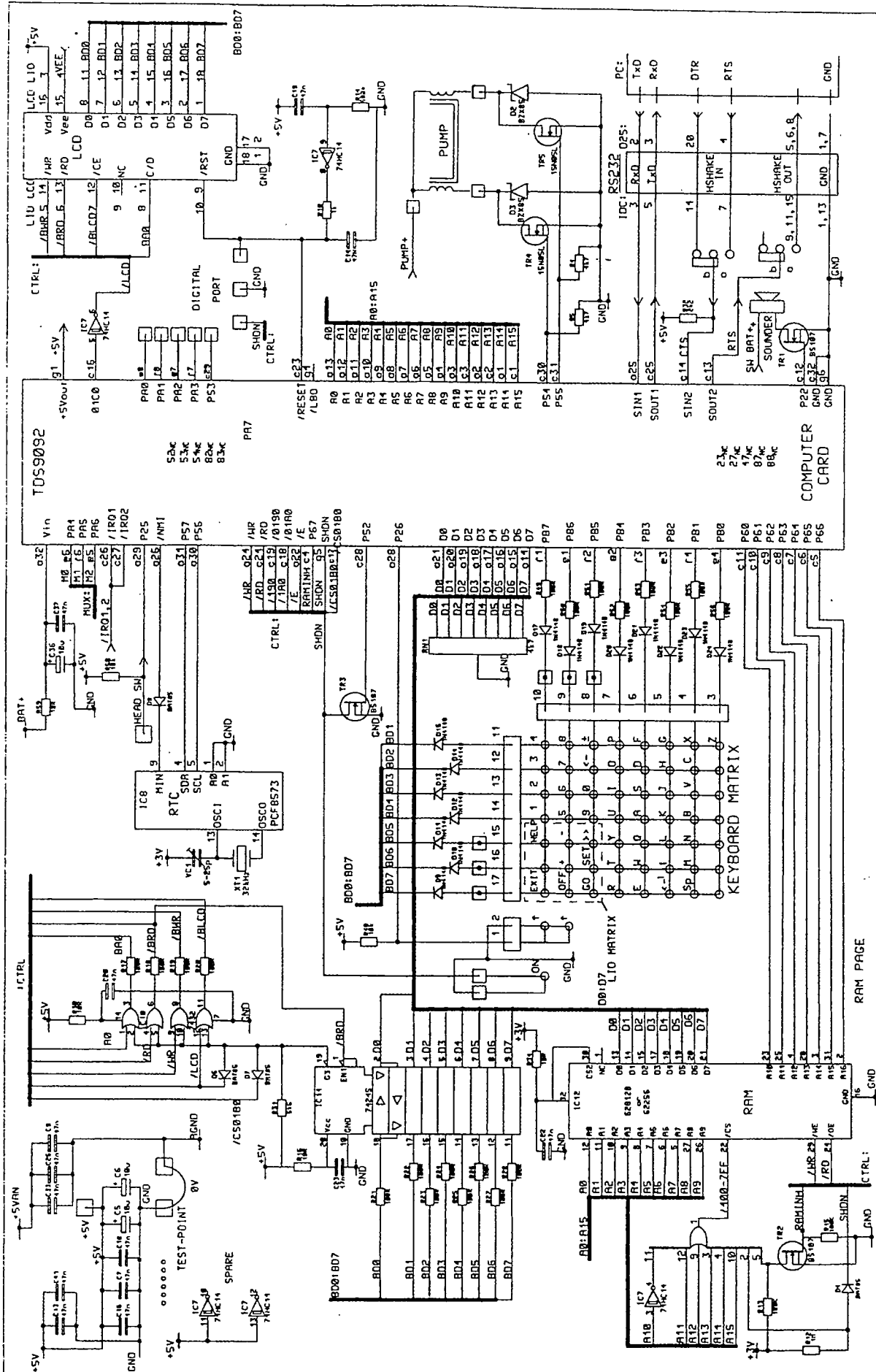

AT Delta-T Devices Ltd.
 128, Lov Rd, Burwell, Cambridge CB5 0EJ, UK.
 Telephone: 01638 742922 Fax: 01638 743155

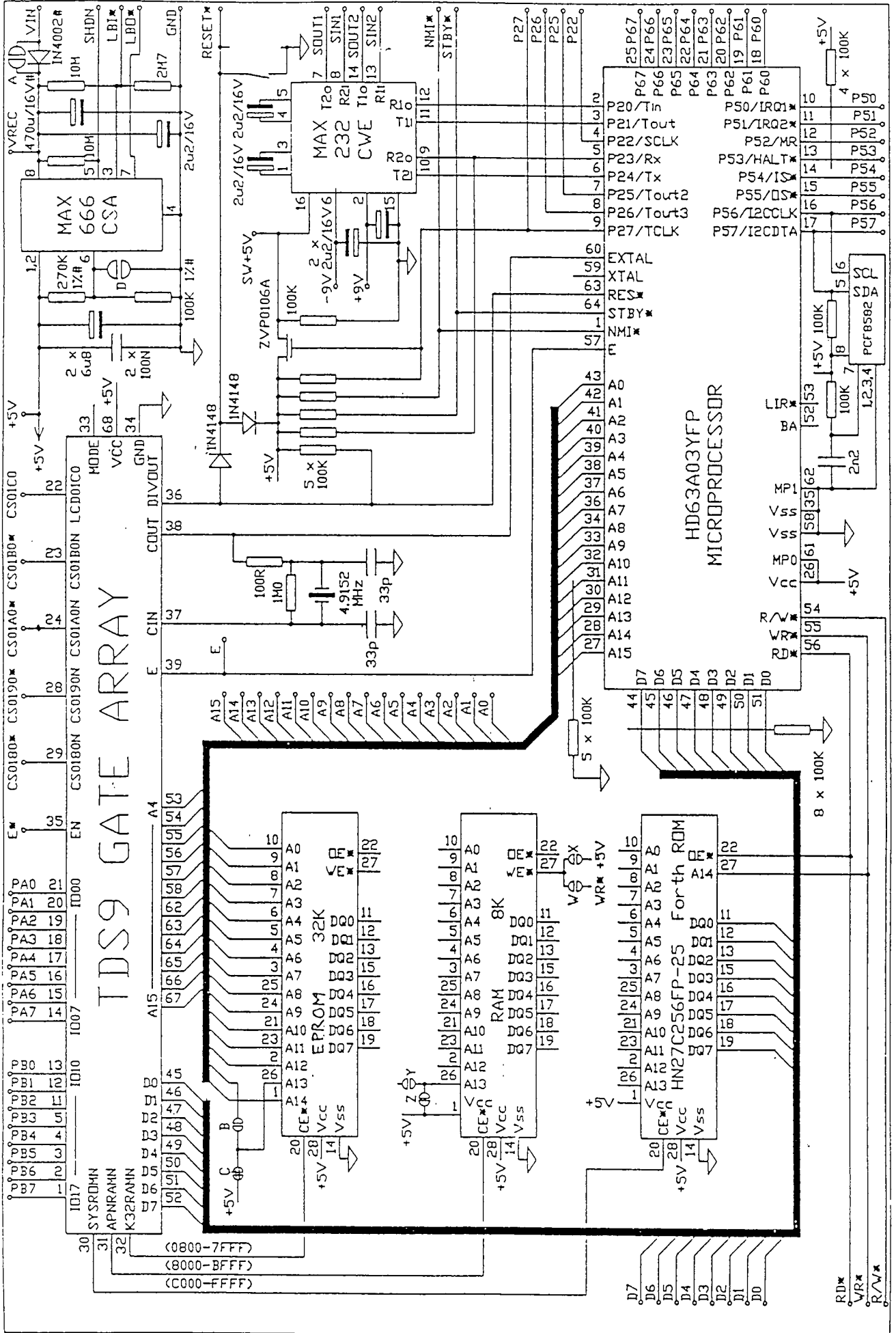

© 1988 TDS Ltd

— shows card connections
 * Indicates signal negative active
 † Component not normally fitted

TDS9090.DWG Rev 1.20 28.Nov.88

TDS9092 Forth Computer

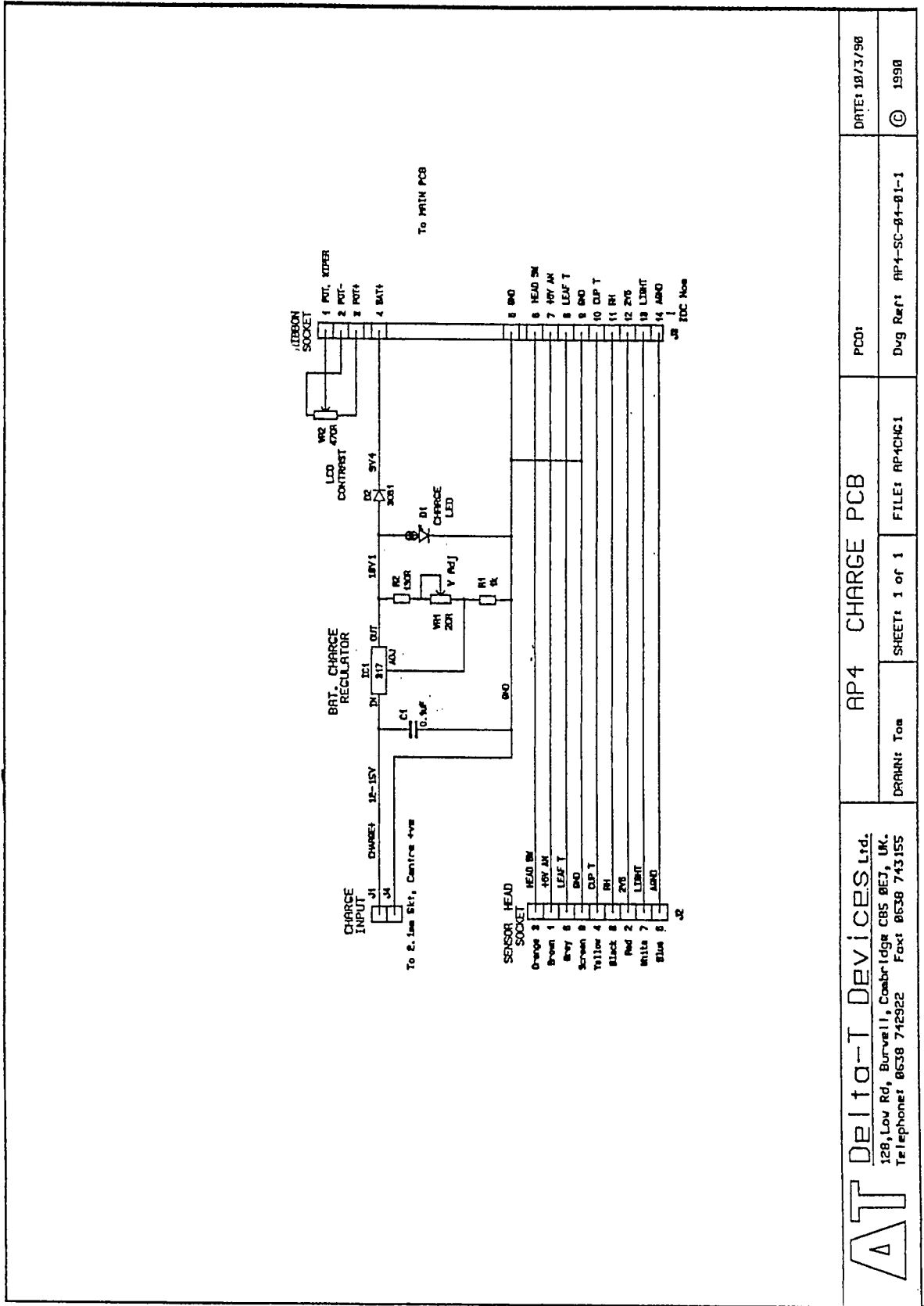

AT Delta-T Devices Ltd.
 128, Lov Rd, Burwell, Cambridge CB5 8EJ, UK.
 Telephone: 0638 742322 Fax: 0638 743155

AP4 CHARGE PCB

PCD: DATE: 18/3/98

DRWNR: Tca SHEET: 1 of 1 FILE: RP4CHC1

Dwg Ref: AP4-SC-B4-01-1 © 1998

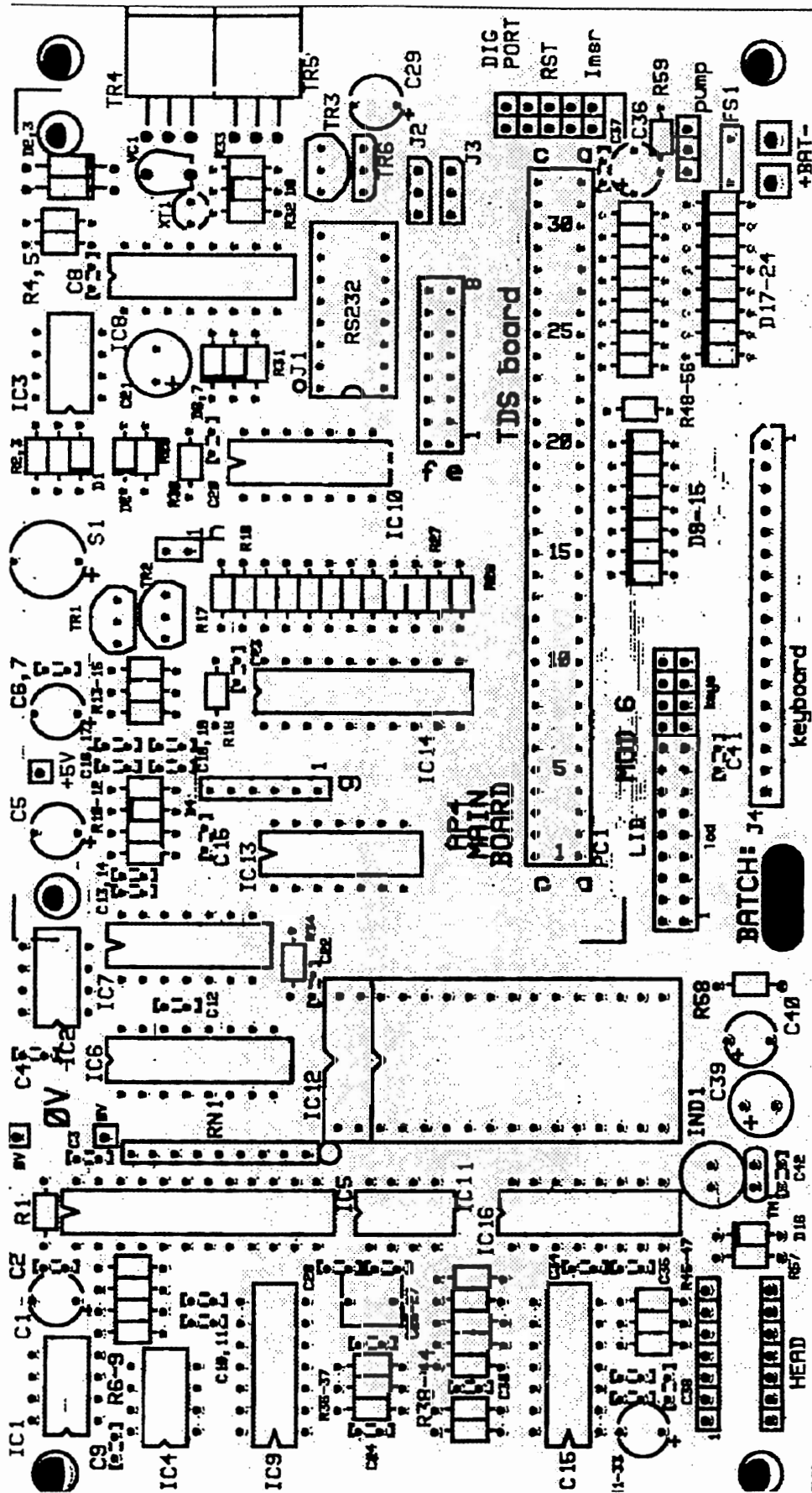

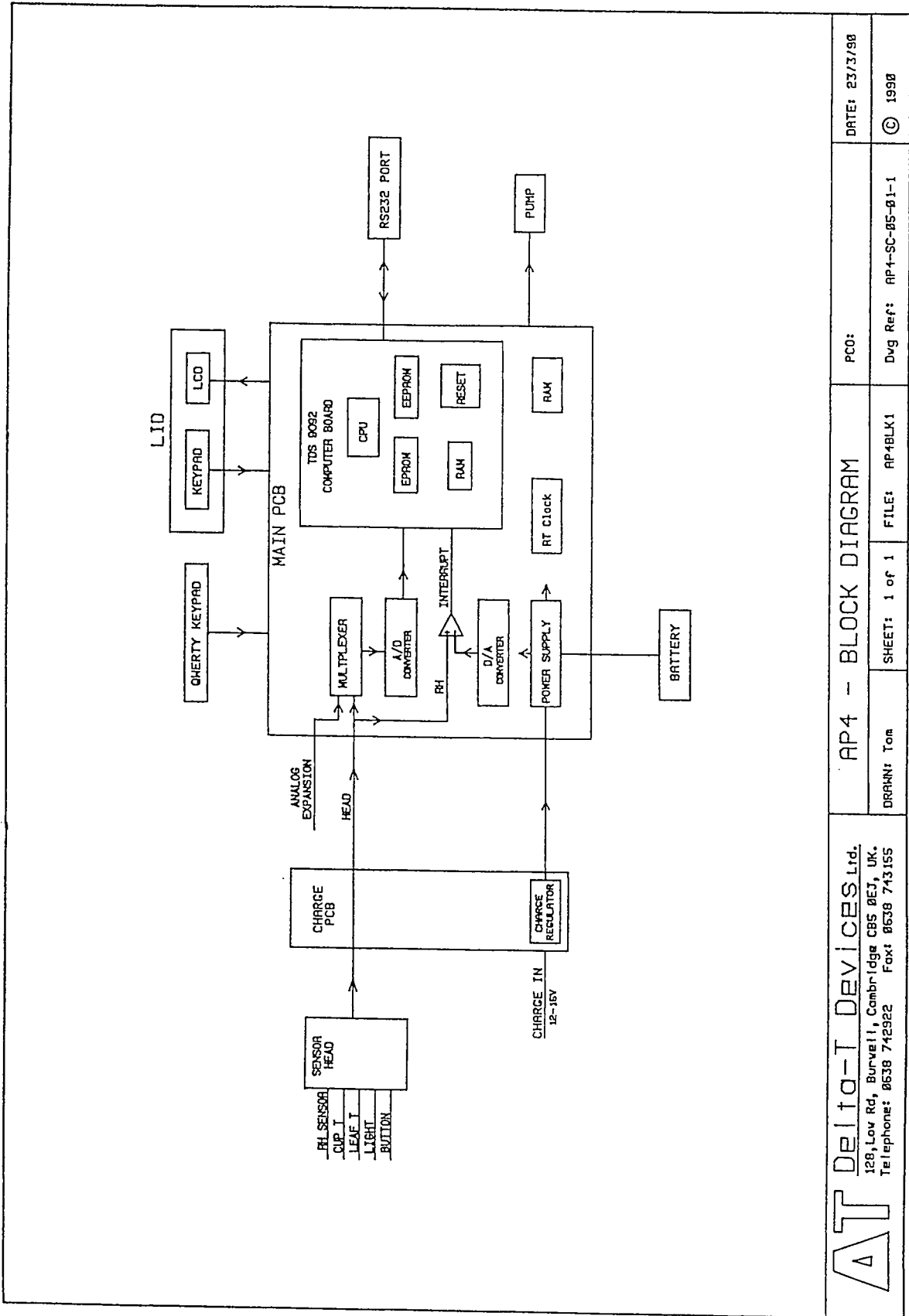

AT Delta-T Devices Ltd. 128, Low Rd, Burwell, Cambridgeshire CB8 8EJ, UK. Telephone: 0638 742922 Fax: 0638 743155		AP4 - BLOCK DIAGRAM		PCO:	DATE: 23/3/98
		DRANN: Tom	SHEET: 1 of 1	FILE: AP4BLK1	Dvg Ref: AP4-SC-B5-01-1

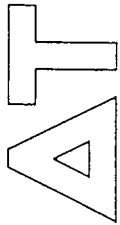
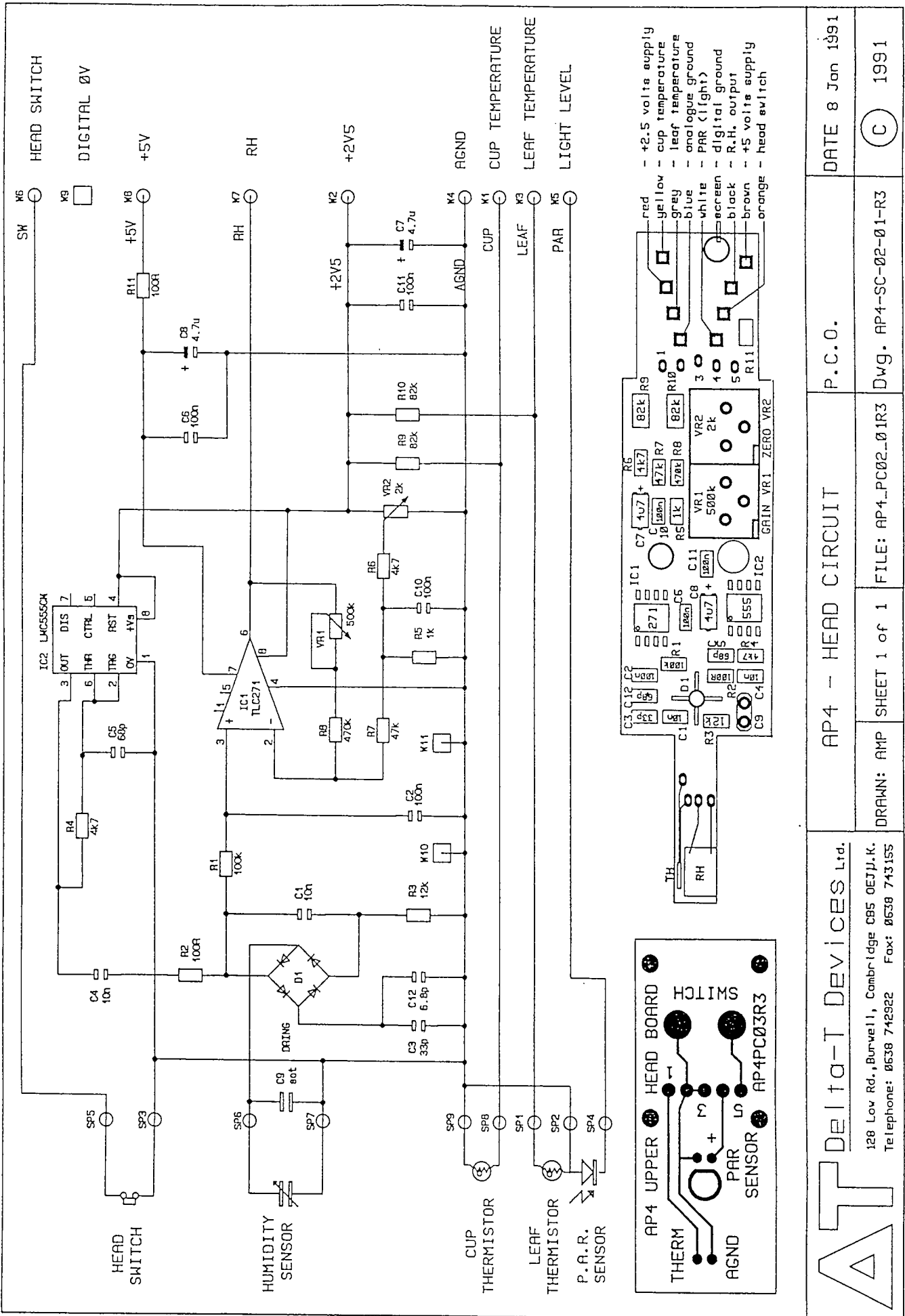

Delta-T Devices Ltd.
 128 Lov Rd., Burwell, Cambridge CB5 0EJ, U.K.
 Telephone: 0638 742922 Fax: 0638 743155

AP4 - HEAD CIRCUIT

P.C.O.

DATE 8 Jan 1991

DRAWN: AMP

SHEET 1 of 1

FILE: AP4_PC02_01R3

Dwg. AP4-SC-02-01-R3

1991

13. COMPONENTS & CONNECTORS

(From reference document AP4-PL-01-3)

MAIN PCB MOD No: 6

	No.	Value	Tolerance %
RESISTORS	R1	10R	1%
	2	430K	1%
	3	510K	1%
	4	4.7K	1%
	5	4.7K	1%
	6	220R	1%
	7	1K	1%
	8	100K	1%
	9	100K	1%
	10	1K	1%
	11	100K	1%
	12	1M	1%
	13	100K	1%
	14	680K	1%
	15	100K	1%
	16	10R	1%
	17	100R	1%
	18	100R	1%
	19	100R	1%
	20	100R	1%
	21	100R	1%
	22	100R	1%
	23	100R	1%
	24	100R	1%
	25	100R	1%
	26	100R	1%
	27	100R	1%
	28	100R	1%
	29	1K	1%
	30	10R	1%
	31	5.6K	1%
	32	2.2K	1%
	33	10R	1%
	34	10R	1%
	35	39K	1%
	36	100K	1%
	37	10K	1%
	38	10K	1%
	39	68K	1%
	40	68K	1%
	41	10K	1%
	42	100K	1%
	43	100K	1%
	44	5.6M	1%
	45	100K	1%
	46	300K	1%
	47	750R	1%
	48	10K	1%
	49	10K	1%
	50	100R	1%
	51	100R	1%
	52	100R	1%
	53	100R	1%
	54	100R	1%
	55	100R	1%
	56	100R	1%
	57	3.3K	1%
	58	10K	1%
	59	10R	1%

R. NETWORK	RN1	4.7K	8 Res SIL
THERMISTOR	TM1	33K	10%
CAPACITOR	C1	10 μ	TANT, 16V
	2	47 μ	SKYCAP
	3	47 μ	SKYCAP
	4	47 μ	SKYCAP
	5	10 μ	TANT, 16V
	6	10 μ	TANT, 16V
	7	47 μ	SKYCAP
	8	47 μ	SKYCAP
	9	47 μ	SKYCAP
	10	47 μ	SKYCAP
	11	47 μ	SKYCAP
	12	47 μ	SKYCAP
	13	47 μ	SKYCAP
	14	47 μ	SKYCAP
	15	47 μ	SKYCAP
	16	47 μ	SKYCAP
	17	47 μ	SKYCAP
	18	47 μ	SKYCAP
	19	47 μ	SKYCAP
	20	47 μ	SKYCAP
	21	220 μ	ELEC, 25V
	22	47 μ	SKYCAP
	23	47 μ	SKYCAP
	24	1000p	CERAMIC
	25	47 μ	SKYCAP
	26	1 μ	MKS2
	27	220p	CERAMIC
	28	47 μ	SKYCAP
	29	10 μ	TANT, 16V
	30	47 μ	SKYCAP
	31	47 μ	TANT, 6V3
	32	47 μ	SKYCAP
	33	47 μ	SKYCAP
	34	47 μ	SKYCAP
	35	47 μ	SKYCAP
	36	10 μ	TANT, 16V
	37	47 μ	SKYCAP
	38	47 μ	SKYCAP
	39	220 μ	ELEC, 25V
	40	10 μ	TANT, 16V
	41	47 μ	SKYCAP
	42	47 μ	SKYCAP
TRIM-CAP	VC1	5-25P	CERAMIC
INDUCTOR	IND1	4.7mH	
ICs	IC1	REF43GP	
	2	MAX666CPA	
	3	MAX666CPA	
	4	TLC27M2CP	
	5	AD7579JN	
	6	TLC7524CN	
	7	74HC14	
	8	PCF8573P	
	9	TLC27L4CN	
	10	74HC32	
	11	RC4391NB	
	12	HM62256LPI12	
	13	74HC4078	
	14	74HC245	
	15	TLC27L4CN	
	16	MC4051	
TRANSISTOR	TR1	BS107	
	2	BS107	
	3	BS107	
	4	STP15N05L	
	5	STP15N05L	
	6	ZVP2106A	

DIODE	D1	BAT85
	2	BZX85C20
	3	BZX85C20
	4	BAT85
	5	IN4148
	6	BAT85
	7	BAT85
	8	BAT85
	9 - 24	IN4148
CRYSTAL	XT1	32kHz WATCH
FUSE	FS1	THERMAL FUZE
BUZZER	S1	AL-175

HEAD BOARD : Parts list for :- AP4_PC_02_R3 (Main head)

The Head parts are small surface mount ones and we do not recommend field replacement. They are listed below for reference.

IC1	TLC271	Amplifier
IC2	LMC555CM	Oscillator
D1	DRING 5082 2830	Detector
RH1	Vaisala HM1518	RH Sensor
TH1	M&M 100k6MCOX	Chamber thermistor
FC1	T&B FB5CJ1.25A	Inter-PCB cable

R1	100k	R0805
R2, R11	100R	R0805
R3	12k	R0805
R4, R6	4k7	R0805
R5	1k	R0805
R7	47k	R0805
R8	470k	R0805
R9, R10	82k	R1206
VR1	500k	POT3720
VR2	2k	POT3720
C1, C4	10n	C0805
C2,6,10,11	100n	C0805
C3	33p	C0805
C5	68p	C0805
C7, C8	4.7u	C1206E
C9	s.o.t.	0.1" pitch
C12	6.8p	C0805

Parts list for :- AP4_PC_03_R3 (Top head)

SW1	Switch	Radiatron	1241-1111-6-9
TH1	Thermistor	M&M	100k6MCDX
CN1	5w Connector	Molex	90121-5w
LD1	PAR light sensor	Centronics	CP1511C

Connectors

MAIN PCB CONNECTORS

=====

MAIN PCB "HEAD": 14-PIN DIL to RIBBON

IDC		IDC Pin1: top left	
PIN	FUNCTION		
1	POT, WIPER		
2	POT, -	CONNECTION to HEAD Lead:	
3	POT, +	-----	
4	BAT+	PIN	WIRE COLOUR
5	Ground	-----	
6	HEAD Switch	3	ORANGE
7	+5V AN	1	BROWN
8	LEAF Thermistor	6	GREY
9	Ground	Scr	Screen
10	CUP Thermistor	4	YELLOW
11	RH	8	BLACK
12	2V5	2	RED
13	LIGHT	7	WHITE
14	Analog GrouND	5	BLUE

LID to MAIN PCB: 26-WAY IDC / RIBBON

IDC LCD		IDC Pin1: lower left	
PIN	PIN	FUNCTION	
1	18	D7	
2	17	D6	
3	16	D5	
4	15	D4	
5	14	D3	
6	13	D2	
7	12	D1	
8	11	D0	
9	10	/RST	
10	9	No Connection	
11	8	A0	
12	7	/CE for LCD	
13	6	/RD	
14	5	/WR	
15	4	Vee, -6 to -10V	
16	3	+5V	
17	2	Ground	
18	1	Ground	(LCD pins 19 ,20: NC.)
LID Membrane Keys			
19	1	Ground	
20	2	ON KEY	To SHutDown
21	3	KEY EXCITE: PB6	
22	4	KEY EXCITE: PB5	
23	5	KEY EXCITE: PB7	
24	6	KEY READ 5	To D5
25	7	KEY READ 7	To D7
26	8	KEY READ 6	To D6
(Lid Membrane pins 9, 10: no connection)			

QUERTY to MAIN PCB: 17-way SIL

SIL Pin FUNCTION Pin1: right

SIL Pin	FUNCTION	Pin1: right
1	SHIFT KEY	To P26
2	Ground	
3	KEY EXCITE: PB0	
4	KEY EXCITE: PB1	
5	KEY EXCITE: PB2	
6	KEY EXCITE: PB3	
7	KEY EXCITE: PB4	
8	KEY EXCITE: PB5	
9	KEY EXCITE: PB6	
10	KEY EXCITE: PB7	
11	KEYPAD READ 1	To D1
12	KEYPAD READ 2	To D2
13	KEYPAD READ 3	To D3
14	KEYPAD READ 4	To D4
15	KEYPAD READ 5	To D5
16	KEYPAD READ 6	To D6
17	KEYPAD READ 7	To D7

RS232 to MAIN PCB: 16-way DIL

IDC Dcon FUNCTION IDC Pin 1: Top Left

IDC Pin	FUNCTION	IDC Pin 1: Top Left
1	1 Ground	
2	14 /RESET	Short to pin1 to Reset AP4
3	2 RECEIVED DATA	Into AP4
4	15 NC	
5	3 TRANSMITTED DATA	From AP4
6	16 NC	
7	4 RTS, HANDSHAKE IN	IF Jumper 3, position "a"
8	17 NC	
9	5 HANDSHAKE OUT	IF Jumper 4, position "a"
10	18 NC	
11	6 HANDSHAKE OUT	IF Jumper 4, position "a"
12	19 NC	
13	7 Ground	
14	20 DTR, HANSHKE IN	IF Jumper 3, position "b"
15	8 HANDSHAKE OUT	IF Jumper 4, position "a"
16	21 NC	

DIGITAL PORT : 10-Way IDC - MAINLY FOR TEST

IDC Pin FUNCTION IDC Pin 1: Bottom Left

IDC Pin	FUNCTION	IDC Pin 1: Bottom Left
1	From BAT+	Jumpered to 2:
2	PUMP+, to circuits	for current measurement
3	SHutDown	Connection to GND switches ON
4	Ground	
5	P53	Spare Digital In/Out
6	/RESET	Connection to GND Resets
7	PA2	
8	PA3	Spare Digital Outputs
9	PA0	
10	PA1	

Connectors

ANALOG EXPANSION PORT : 6-Way 3x2 socket

Pin	FUNCTION	Pin 1: Bottom Left
1	Ground	Analog Ground
2	+2V5	Reference Voltage
3	SPare ANalog input	On Multiplexer Address 2
4	NC	
5	DAC	DAC Output, 0-2V5, 8 bits
6	+5VAN	+5V,q5% @ 30mA

13. SPARES, CONSUMABLES AND ACCESSORIES

SPARES KIT: Type PSK1

ITEM	DETAILS
Lid ribbon cable	
Pump Assembly	Whisper 200 or AP50
Air inlet airline	
Air outlet airline	
Case hinge x 2	
Lid gasket	3mm ERC x 700mm
Nuts, bolts and rivets	Assorted
Charger board cable	
Qwerty board cable	
25 (male) to 9 (female) pin adaptor	
Universal RS232 Cable assembly	
Desiccant in container tube	
Cup insert x 2	white polypropylene
Cup seal x 2	grey silicon rubber
Cup gasket	white silicon rubber
Cup RH sensor	
Cup thermistor	
Head flexible connector	
Head Go button	
Leaf pressure pad and thermistor	
Head cable assembly	
Charge socket	
Calibration plate	white polypropylene
Pouch for calibration plate	
Glue	Araldite
Glue	White silicon rubber
Glue	Clear silicon rubber
Glue	Clear silicon rubber
User manual	

CONSUMABLES KIT: Type PCK1

Calibration pad	Packet of 100
Silica gel crystals	500g
Tape	
Cup seal	
Cup insert	
Cup gasket	
Silica gel container tube	
Screws x 2	M4 x 8mm nylon

OTHER OPTIONAL ACCESSORIES

One barometer, wristwatch type PBR1.

Spare sensor head, type PSH1.

Spare AP4 re-chargeable battery, type PSB1

Charger for AP4 battery, specify 240V, 220V or 110 V.

15. SERVICE AND GUARANTEE

SERVICE

We recognise that some users of our instruments may not have easy access to technically specialised support.

Should it be necessary, instruments may be returned to our works for servicing. We normally expect to complete repairs of our instruments within two working days of receiving the equipment.

Contact us first before sending any repairs.

Users of our equipment in countries which have a Delta-T agent or Technical Advisor should contact them in the first instance.

GUARANTEE

Instruments manufactured by Delta-T are guaranteed for one year against defects in manufacture or materials used. The guarantee does not cover damage through misuse or inexpert servicing, or other circumstances beyond our control.

For the U.K. this means that no charges are made for labour, materials or return carriage for guarantee repairs.

For other countries, the guarantee covers free exchange of faulty parts during the guarantee period. Alternatively, if the equipment is returned to us for repair under guarantee, we make no charge for labour or materials but we do charge for carriage and U.K. customs clearance.

We strongly prefer to have such repairs discussed with us first, and if we agree that the equipment does need to be returned, we may at our discretion, waive these charges.

APPENDIX A : DESIGN OF THE AP4

This section describes the insights produced as a result of modelling the dynamic behaviour of the earlier, AP3, cup by using 2-dimensional finite element analysis.

It also describes the refinement of the calculation of the values of the calibration plate using 3-dimensional finite element analysis.

MODELLING OF CUP PERFORMANCE

A computer model of the Mk 3 porometer cup was created, using the method of finite element analysis. It incorporated a 2 dimensional representation of the head geometry, variations in leaf resistance, dry air flow, and sensor response time. The model calculated the RH throughout the cycle at every point on a 0.5 mm grid on a section through the cup.

In this earlier design the dry air was fed in from the side.

A typical set of RH contour maps at different times through the cycle, is shown opposite.

Section through Cup

Plot of RH contours

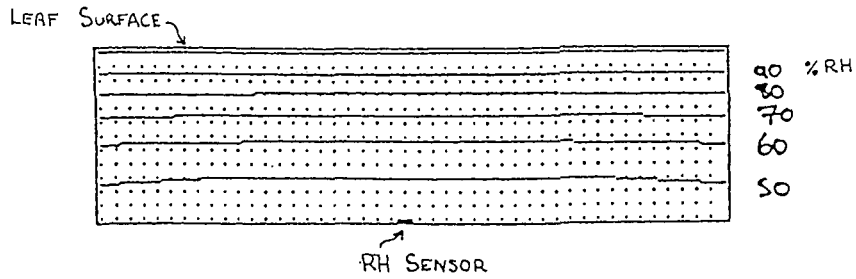

"Ideal" cup

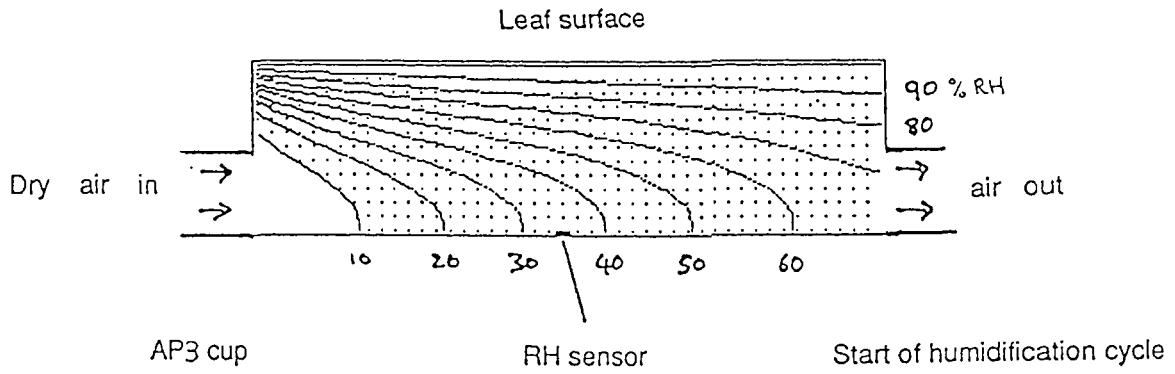

AP3 cup

RH sensor

Start of humidification cycle

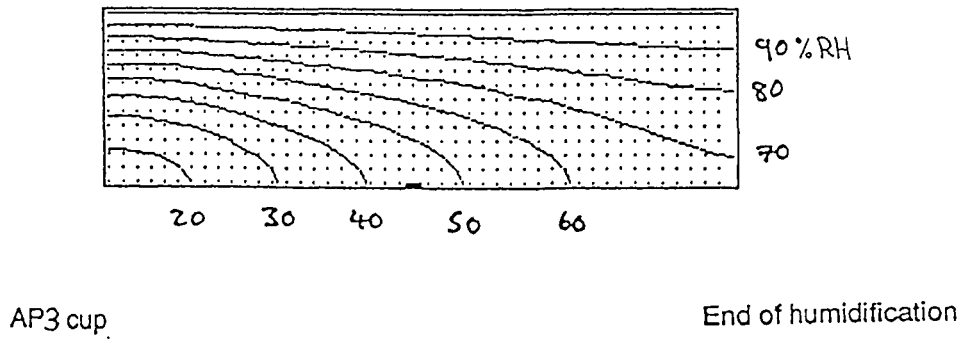

AP3 cup

End of humidification

The calibration curves produced by the finite element analysis of the cup model are shown opposite. (These assume the resistance value is known perfectly, and should not be confused with the theory and calculation of resistance values given below).

POINTS OF INTEREST

- There is a significant gradient along the cup due to the direction of the drying airflow.
- This accounts for some of the bend in the calibration curve.
- The finite response time of the sensor also contributes to the bend in the curve.
- The Monteith et al theory gives the same linear curve as the model with an "ideal cup" ie starting from a uniform RH of 0% throughout and with an RH sensor with zero response time.
- A real cup is significantly slower than the model. This appears to be due to the effects of water absorption on the surface within the cup, which was not included in the finite element analysis model.
- The Monteith et al theory can be applied to the discrepancy to calculate the mass of water absorbed by the walls of the cup. It turns out to be a few micrograms.

CONSEQUENCES

The AP4 cup has been designed to introduce the drying air in the opposite direction to the RH gradient, rather than perpendicular to it. This produces more uniform cup conditions, reduces the extremes of RH across the cup, and hence reduces the possibility of leaf stress.

Graph of resistance versus transit times predicted for the cup when the resistance is known perfectly.

Key

- Prediction from the Monteith et al equation and also the model results assuming an "ideal" case when the sensor response time is zero and the cup starts at 0% RH everywhere. This is a straight line.
- - Predicted by the model cup with: air flushing vertically, and RH sensor with finite response time.
- . - Air flushing horizontally and RH sensor with finite response time.
- - - Test data from a Delta-T AP3 porometer.

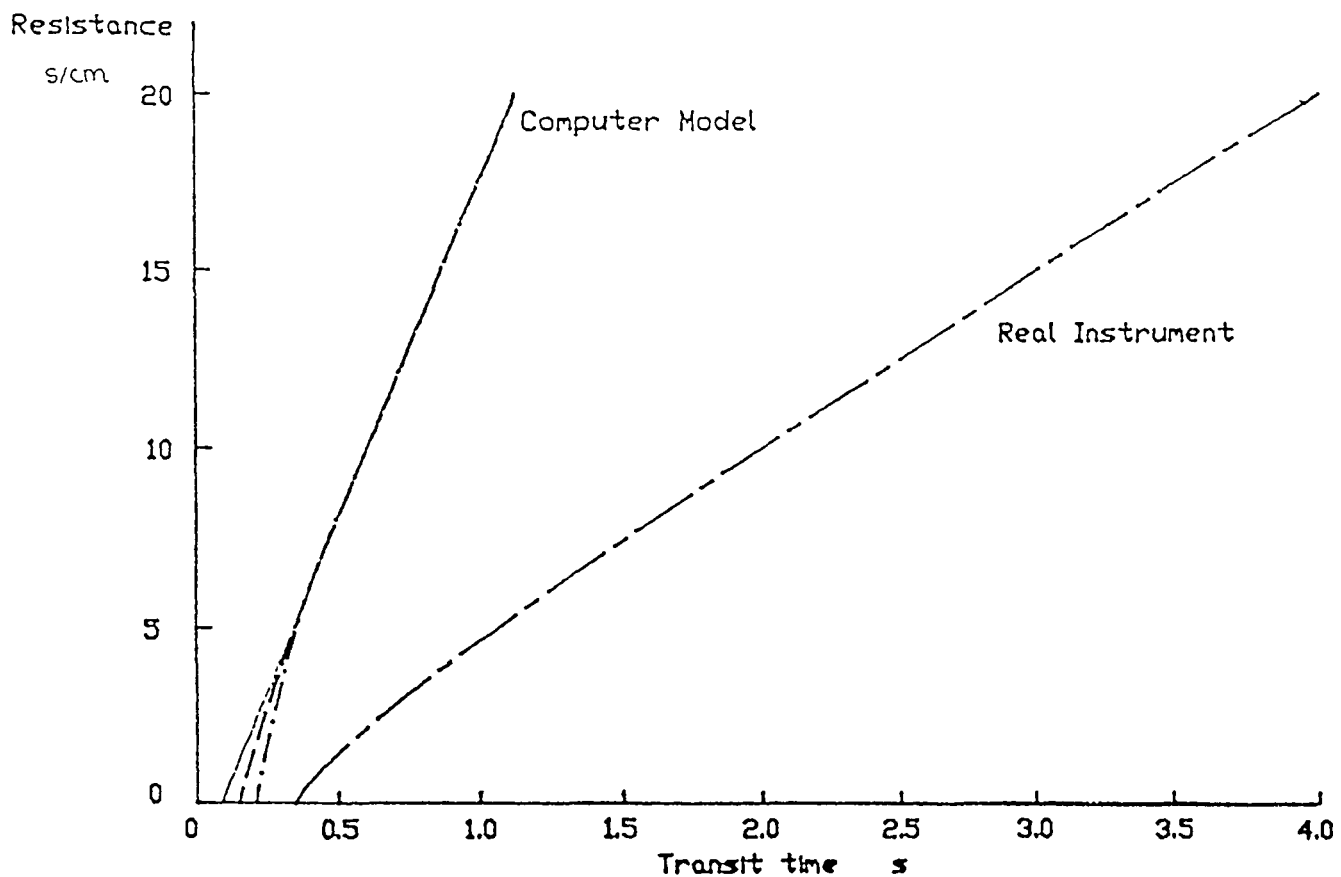

Calibration curves

MODELLING CALIBRATION PLATE PERFORMANCE

An advantage of the cycling porometer is that it does not rely on the absolute accuracy of its RH sensor. Readings are derived from a comparison with a calibration plate. Regular calibration gives confidence in the repeatability of measurements. However, the accuracy depends on how accurately we know the value of the calibration plate (amongst other things).

We use a perforated polypropylene plate, backed with a moist filter paper to provide this standard. The resistance of the pore groups is calculated from their known dimensions. In the past we have used a formula by Brown and Escombe (1900). This is based upon the assumption of a single pore above an infinite plane. More recently an alternative calculation has been proposed by Chapman and Parker (1981) based upon diffusion through concentric cylinders of different diameter, see opposite.

Neither of these exactly match the geometry of the actual calibration plate and cup combination, which consists of a row of pores diffusing into a rectangular slot. We have therefore modelled the calibration plate using finite element analysis. A commercial finite element analysis program was used (LUSAS, Finite Element Analysis Ltd, London). This ran on a DEC VAX computer at the Department of Engineering at Cambridge College of Arts and Technology.

A typical RH contour map is shown over the page.

RESULTS

Plate Position	Resistance (s cm ⁻¹)			Values used in the AP4
	B & E	C & P	F.E.A.	
1	26.4	25.8	27.3	27.3
2	16.3	15.6	16.5	16.5
3	7.5	7.0	7.4	7.4
4	3.4	2.9	3.1	3.1
5	2.0	1.5	1.6	1.6
6	1.4	0.7	0.8	0.8

When performed on cylindrically symmetric sections the finite element analysis agreed to within 1% with the Chapman-Parker results. But the FEA results were about 6% higher using the non-symmetric geometry of the actual cup. We attribute this discrepancy to the non-ideal assumption of symmetry required by the Chapman-Parker theory. Therefore in the AP4 we use the finite element analysis results.

The Brown & Escombe values show significant errors at low resistances. An applications note on the implications of these refinements for previous Mark 3 porometer users is in preparation.

CALIBRATION PLATE MODELS

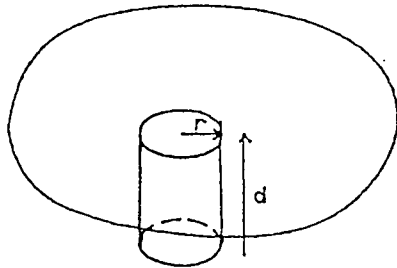

Brown & Escombe model

$$R = \frac{(d + \pi d/4)}{\pi r^2 D}$$

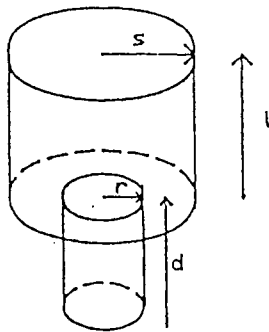

Chapman & Parker model

$$R = \frac{(d + R_d \pi r^2 / s)}{\pi r^2 D}$$

R_d is taken from a table and depends on the ratio of r to s

D is the diffusion resistance

R is independent of l if $l > s$

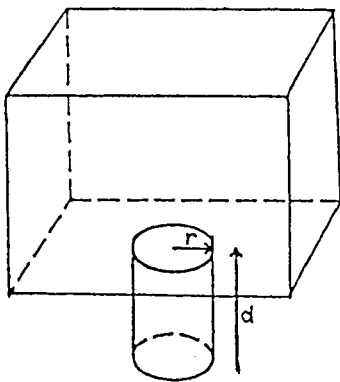

A part of the Delta-T calibration plate and cup geometry used in the Finite Element Analysis

TYPICAL RH CONTOUR MAP CALCULATED BY FINITE ELEMENT ANALYSIS
 Used in calculating calibration plate resistance.

25	50	65	80	95	110	125	140	155	170
24	49	64	79	94	109	124	139	154	169
23	48	63	78	93	108	123	138	153	168
22	47	62	77	92	107	122	137	152	167
21	46	61	76	91	106	121	136	151	166
20	45	60	75	90	105	120	135	150	165
19	44	59	74	89	104	119	134	149	164
18	43	58	73	88	103	118	133	148	163
17	42	57	72	87	102	117	132	147	162
16	41	56	71	86	101	116	131	146	161
15	40	55	70	85	100	115	130	145	160
14	39	54	69	84	99	114	129	144	159
13	38	53	68	83	98	113	128	143	158
12	37	52	67	82	97	112	127	142	157
11	36	51	66	81	96	111	126	141	156
10	35								
9	34								
8	33								
7	32								
6	31								
5	30								
4	29								
3	28								
2	27								
1	26								

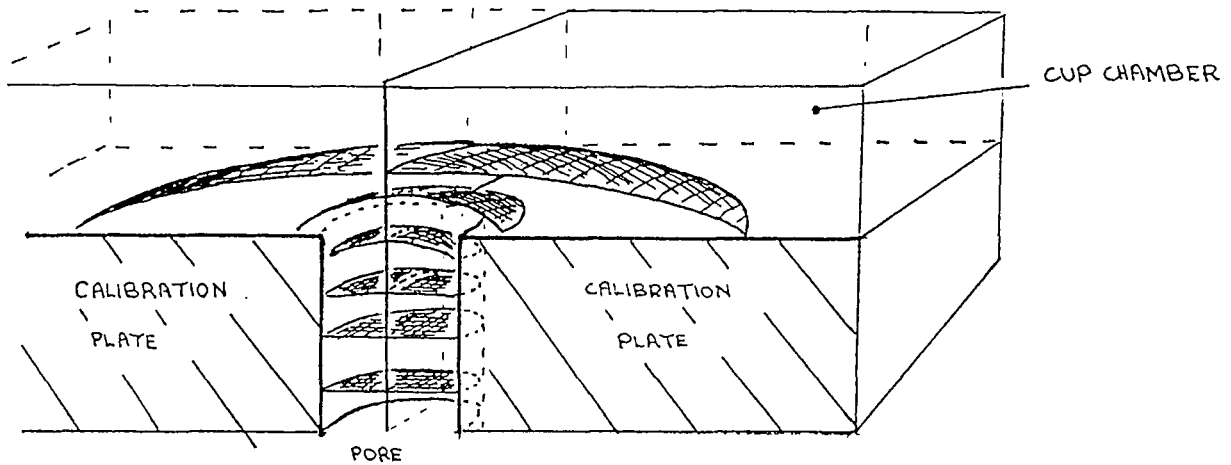

APPENDIX B : TEST RESULTS

There are two parts to this :

- Independent test comparison of version 1 of the AP4, that is, without temperature correction, with our previous model the Mark 3 porometer.

- Experimental basis for the AP4 version 2 temperature correction algorithms.

COMPARISON WITH DELTA-T MARK 3 POROMETER

Version 1 of the AP4 used an automatic calibration curve fitting process, similar to the manual one required for the Mark 3. It did not automatically correct for temperature changes occurring between calibration and reading. Dr Black's report can be taken to confirm that the raw data produced by the AP4 is close to that produced by our previous porometer.

Comparison tests were performed at ICRISAT, India, by Dr C. Black in controlled temperature greenhouses using well-watered pot-grown groundnut (TMV2) and pigeonpea (#4251) plants. These were respectively 6-8 and 3-4 weeks old when used. Measurements were made throughout the day between about 0900 and 1800 h IST under a range of weather conditions to obtain as wide a range of stomatal conductances as possible. The air temperature during the measurement ranged between 28.5 and 32.5°C, but was typically 30 to 31°C. The ambient relative humidity was 70-85% and PAR fluence rate ranged between 100-1300 $\mu\text{mol m}^{-2}\text{s}^{-1}$. Measurements were generally made on the younger mature leaves, beginning with the youngest leaf which would fit the porometer, but in pigeonpea some measurements were made on older leaves.

Consecutive measurements were alternated between using the Mark 3 and AP4 first, to avoid introducing any systematic bias. A wide range of conductances was obtained, though the majority were below 1.25 cm s^{-1} . The correlation between the two instruments was good, with most points falling within 10% (dashed lines) of the 1:1 relation (solid line).

There is no evidence that either instrument consistently over- or underestimated conductance. It is not unexpected that there should be some scatter in the relation for several reasons. Firstly, it is difficult to position both sensor heads at exactly the same location, particularly since the Mark 3 samples a larger area (23 x 2.5 mm) than the AP4 (17.5 x 2.5 mm). Furthermore, the values recorded by the second porometer to be used may have been influenced by the preceding measurement with the other instrument, particularly at low conductances where cycling times are longer.

This figure shows the relation between stomatal conductance for the same leaflets of ground nut measured using the Delta-T Mark 3 and the AP4 (version 1) porometer with the slotted cup.

KEY

1L, 1U, 2L and 2U refer respectively to the lower and upper surfaces of leaf 1 & 2, the first and second mature leaves numbered from the stem apex. The dashed lines represent 10% deviations from an ideal 1:1 relationship (solid line).

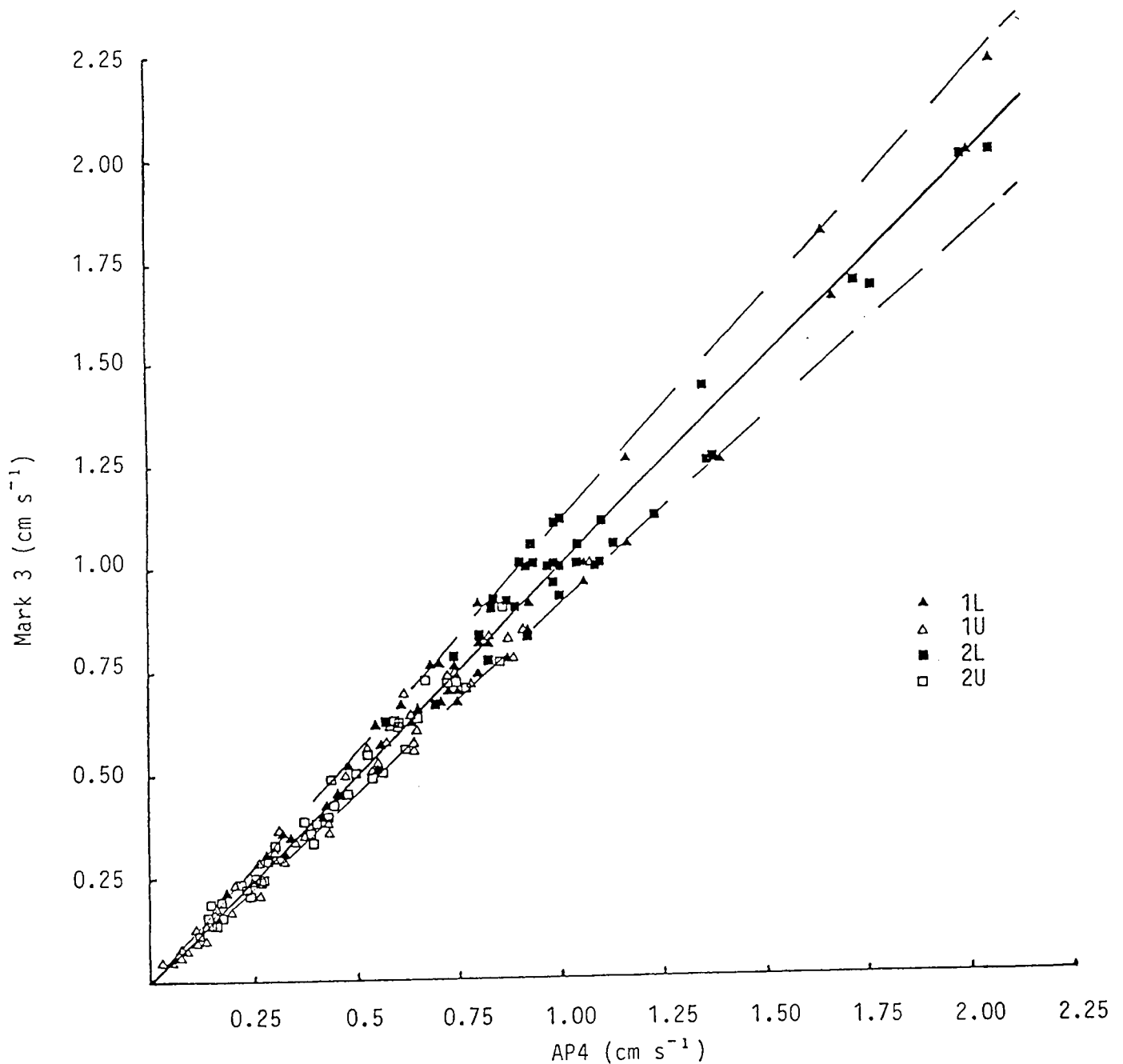

(Reproduced with the kind permission of the Director, ICRISAT, Hyderabad, India, and of the author Dr C Black, 1990)

APPARATUS USED IN TESTING THE AP4 ALGORITHMS

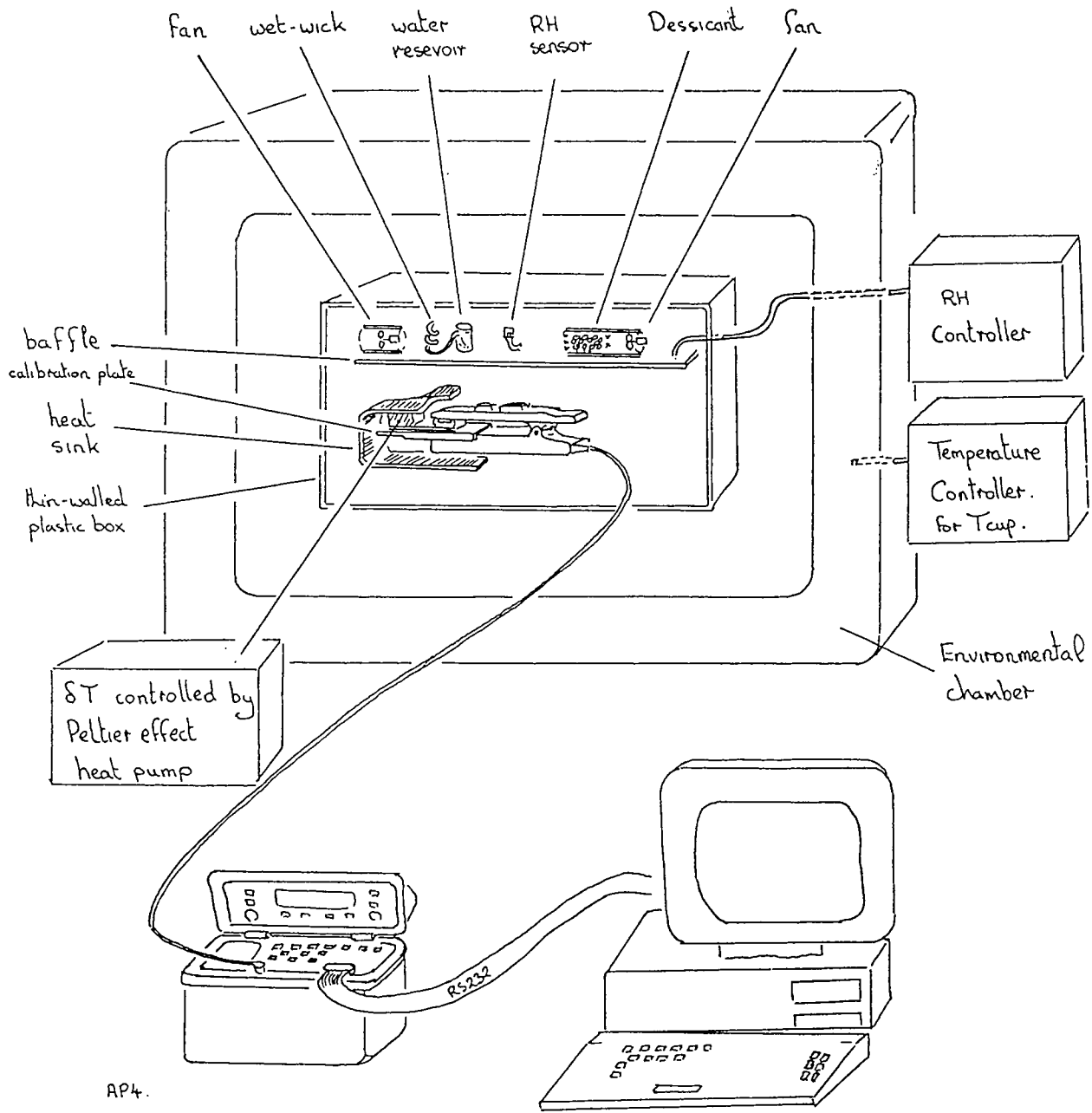

AP4.
Version 1.
modified to continuously
send all data to PC

PC computer logging AP4 output
running Quickbasic software
emulation of AP4 version 2
algorithms

EXPERIMENTAL BASIS FOR THE AP4 ALGORITHMS

■ Introduction

■ Method

■ Results and discussion :

Dependence of L' on transit time δt .

Dependence of L' on temperature.

Validation of cup temperature algorithms.

Validation of cup-leaf temperature difference correction.

■ Conclusion

INTRODUCTION

The AP4 version-2 temperature correction algorithms were developed and validated in Microsoft QuickBasic on a personal computer. This was interfaced, on-line, to receive data from a modified AP4 with its head in an environmental chamber. Once validated these algorithms were then rewritten in FORTH and implemented on the AP4 EPROM. This was retested against the same QuickBasic algorithms in a similar fashion.

First, Wood's equations for L' , the cup parameter, and δt_f , the corrected transit time, were refined and developed along with the rest of the algorithms outlined in chapter 11.2 for calibrating and taking readings. Porometer head cups were exercised through a representative range of RH, cup temperature and leaf-cup temperature differences to validate the algorithms.

The errors in the measured resistances were inspected to determine over what range accuracy was maintained to within 20%. This range is quoted in the performance specification for the accuracy of the temperature correction, as follows:-

If the calibration is done carefully, then the ambient temperature can shift by +10 or -5°C, and the cup-leaf difference by $\pm 2.5^\circ\text{C}$ from that existing at calibration, and yet the reading will remain accurate to $\pm 20\%$

METHOD

The development and validation of the algorithms was made using the apparatus shown in the diagram. The AP4 head was mounted inside an RH-controlled chamber which itself was inside a temperature-controlled cabinet.

The cup-leaf temperature difference was controlled by a Peltier-effect heat pump. A plate thermally connected to one side of the heat pump was inserted in the head, behind the calibration plate - between it and the leaf temperature thermistor. The heat sink connected to the other side of the heat pump completely surrounded the AP4 head.

The RH was adjusted by fans blowing air either over a wet wick, or through a tube of desiccant. The controller was a modified AP3 porometer chassis, connected to both fans and a Vaisala HM1815 RH sensor.

The ambient temperature was regulated by an Austell Hearson Dutaform type BM commercial environmental chamber with a West 2050 programmable controller.

The EPROM of the AP4 was modified to send all the data, from every RH cycle, to an on-line Elonex 2086 computer. This included the transit time, cup temperature, and cup-leaf temperature difference. It also sent the resistance as calculated using the Mark 3 porometer-type calibration process implemented in version 1 of the AP4.

This resistance was measured by interpolating from a calibration curve fitted by the method of least squares to the set of six pairs of transit time and resistance obtained during calibration. No other corrections were used. The readings were output through the serial port at every cycle to the on-line computer.

The porometer was calibrated at every combination of 20, 50 and 70%RH and 10, 25 and 40°C. After each calibration the cup-leaf temperature difference, δT , and the ambient temperature T_{cup} were independently varied, over $\pm 2.5^\circ\text{C}$ for δT , and $\pm 20^\circ\text{C}$ for T_{cup} . The rate of change of temperature was limited by the West controller to 0.2°C per minute, so that each temperature cycle lasted some 6 hours.

At each cycle all the raw data, and the uncorrected resistance was sent to the computer, where the corrected (AP4-derived) resistance was calculated. Every 5 minutes the current readings were logged to disc. A representative sample of such a data set, analysed graphically using Supercalc5, is presented in the following graphs.

RESULTS AND DISCUSSION

Dependence of L' on transit time : δt

L' is the cup length parameter used in Monteith's equations relating transit time to resistance. These are reproduced in chapter 11.2 as equations (1) and (2). The parameter L' is associated with water absorption by the cup walls and RH sensor

In calibration, the six pairs of transit times and known resistances are used to calculate the corresponding six values for L'.

Graph 1 shows these 6 values plotted against δt for a typical set of data. Plotted on log-log axes, they are close to a straight line, so they can be characterised by a quadratic curve. The calibration routine therefore fits a quadratic curve to these points (on the log-log graph). This graph is then used to calculate an appropriate value of L' when taking a reading. The curve typically has a slope near 0.5, and an intercept on the L' axis which depends on the calibration temperature. This relationship forms the basis for the transit time dependent part of the equation for L'. (See equation (4) chapter 11.2)

Cup Absorption

Dependence on transit time
Calibrated at RH50% 24.5°C

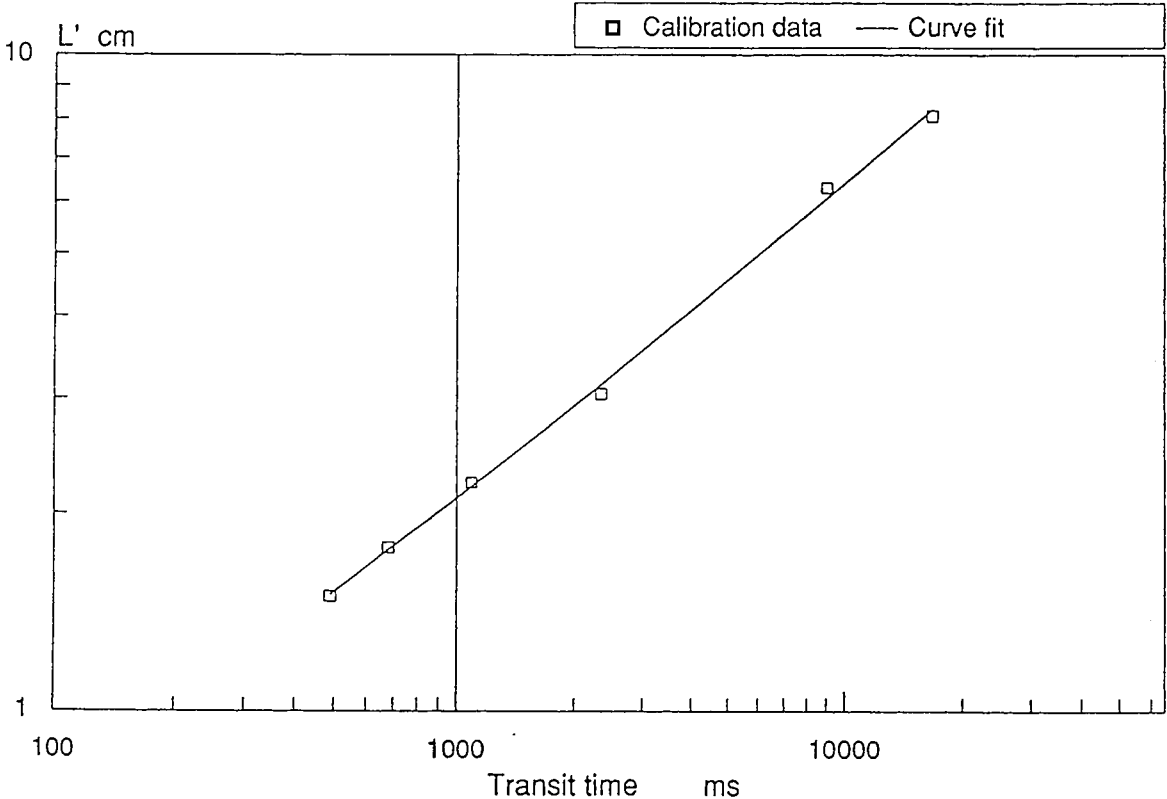

Graph 2 shows the calibration data points interpreted using the AP4 calibration algorithms, plotted in the style of the Mark 3 calibration curve. This graph is included to reassure those familiar with the Mark 3 Porometer.

We include it here because you can think of graph 1 as being the calibration curve in the AP4, of L' vs δt . Whereas the earlier models, the Mark 3 and version 1 of the AP4, used graph 2 as the calibration curve.

Calibration Curve

AP3 style
Calibrated at RH 50% 26.1°C

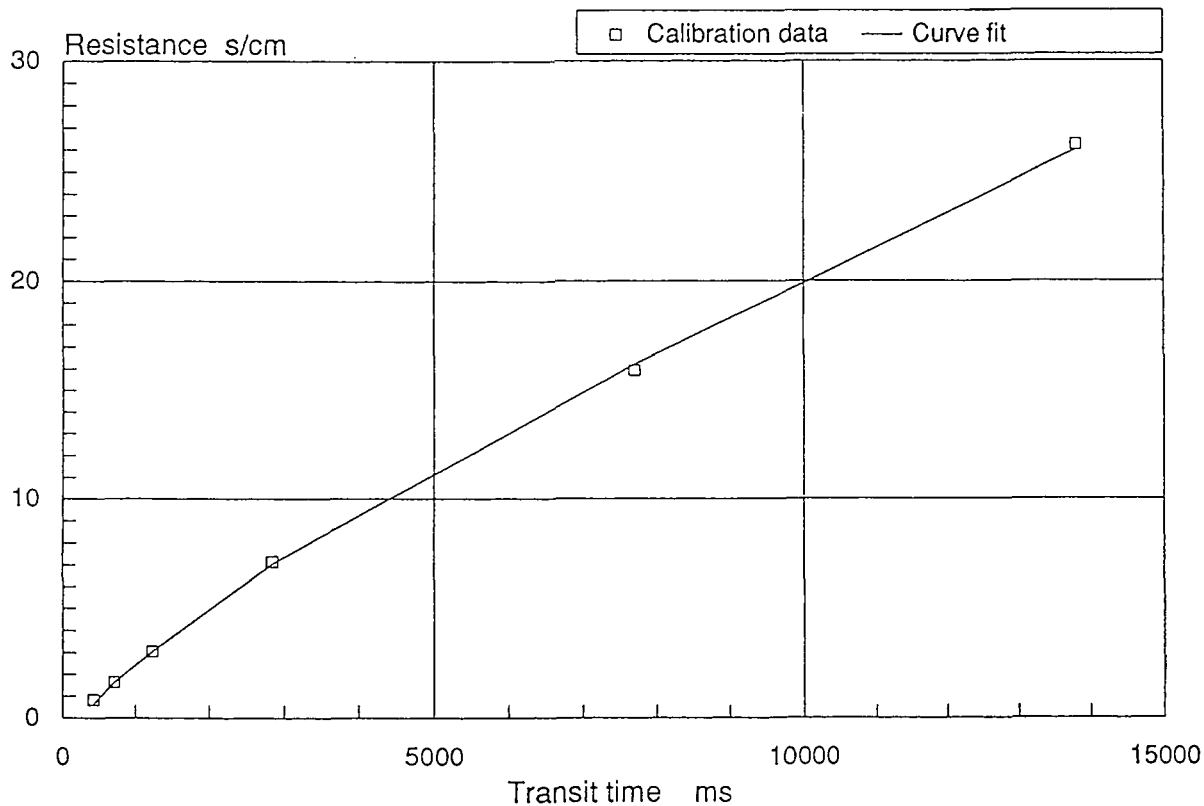

Dependence of L' on temperature

Graph 3 shows the temperature dependent part of L' . A porometer was calibrated, and then left measuring a particular known resistance, ie the calibration plate. The relative humidity of the air around the head was kept constant, while the ambient temperature was varied, and the porometer reading logged. From these readings and the known value of the resistance, L' was calculated for each reading. These values were normalised: using the calibration curve (graph 1) to the equivalent constant value of δt (1000ms). The results show the temperature dependent part of L' for a typical set of data. This gives the temperature dependent part of equation 4 in chapter 11.2.

Cup Absorption

Dependence on temperature
Calibrated at RH 50% 26.1°C

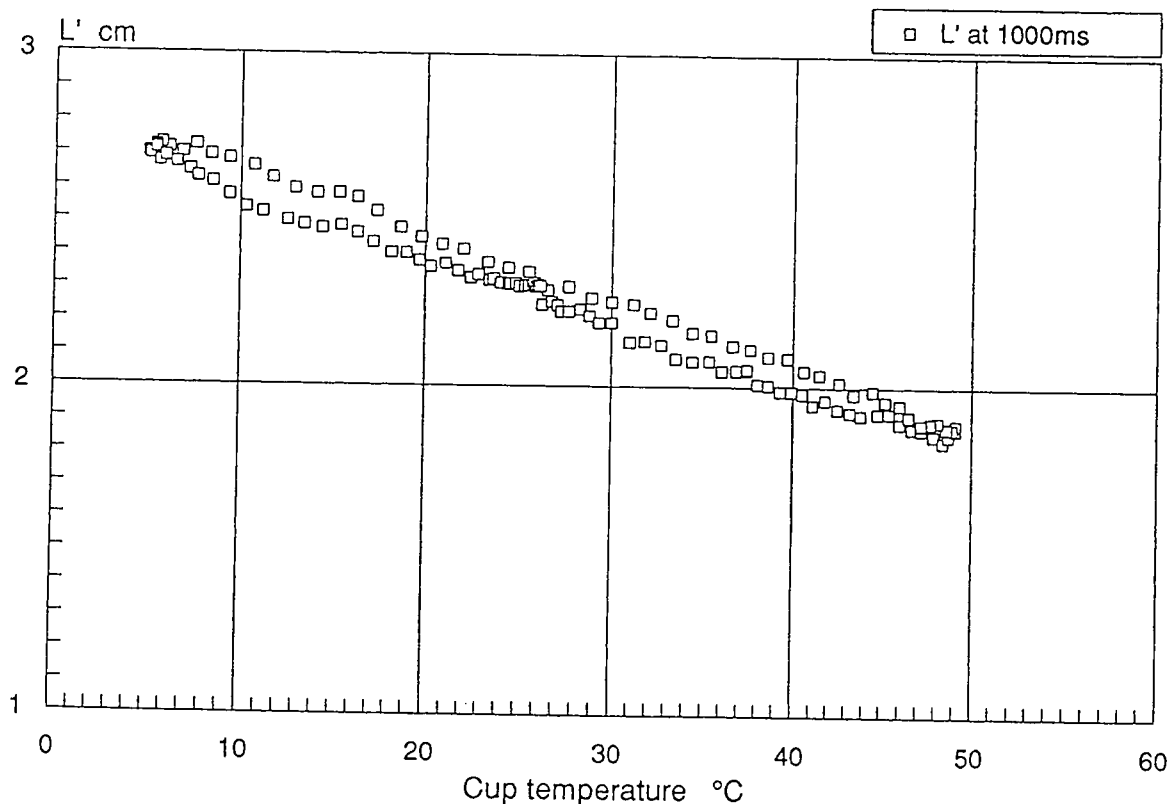

Validation of the cup temperature correction algorithms

Graph 4 compares the resistance measured using the Mark 3 algorithm, which has no temperature correction, with the AP4 version 2 algorithms, which do. Two known resistances are shown, corresponding to two calibration plate positions. The corrected resistances, ie as measured by the AP4 version 2 algorithm, can be seen to fit quite well with the theoretical curve based on the known (theoretical) resistance. These ideal curves are not horizontal because of the temperature dependence of the diffusion coefficient of water vapour in air. They obey equation 7 in chapter 11.2.

The extent to which these readings match the known plate values is a measure of the success of the algorithm in its ability to correct for deviations from the cup temperature existing at calibration. Whilst only two plate positions are shown here, for one particular set of conditions, we find it to be true for the rest of the combinations of parameters which we have so far explored.

A more rigorous statistical analysis of the success of these algorithms has not been applied. But the ability of the algorithms to correct for deviations away from those conditions existing at calibration is much better than we originally expected, and far superior to those previously available for the Mark 3 version.

Cup temperature correction

Calibrated at RH 50% 24.5°C

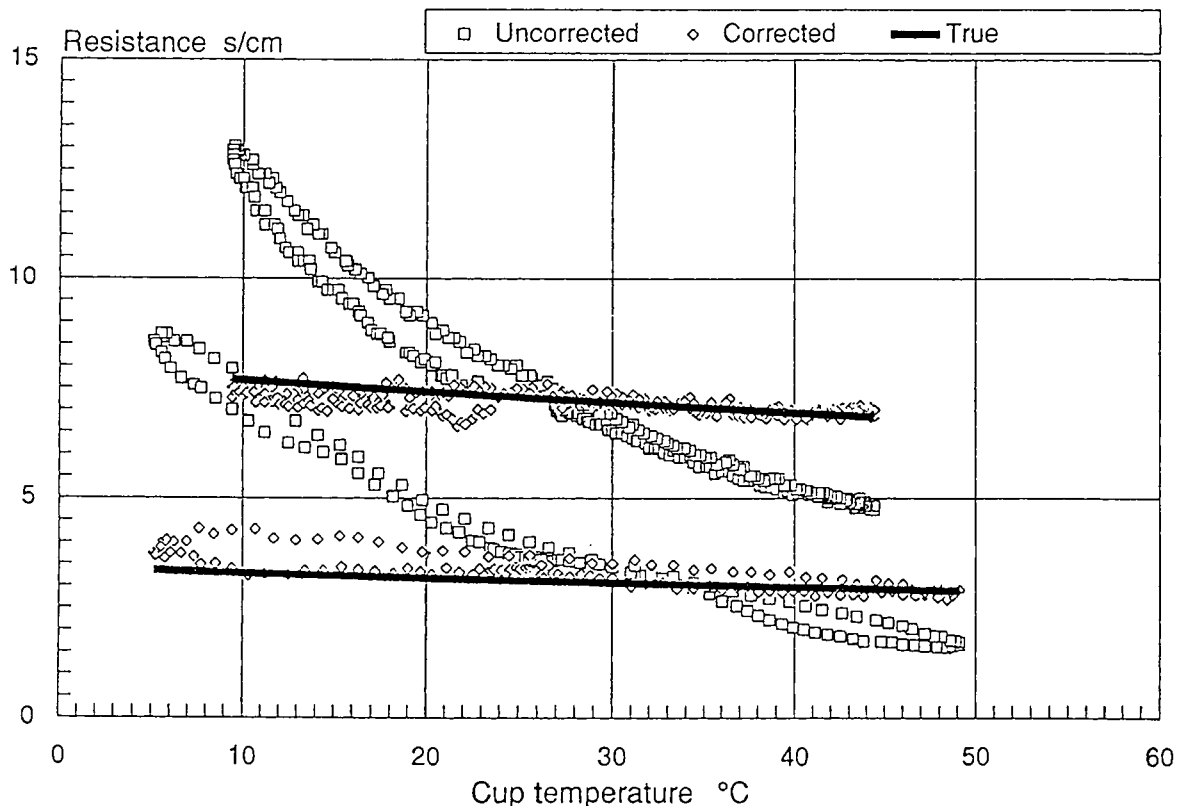

Validation of the cup-leaf temperature difference correction

Graph 5 shows how the corrected and uncorrected measured resistances vary with δT . In this experiment the ambient RH and temperature were kept constant, and the temperature of the calibration plate varied relative to that of the cup using a Peltier-effect heat pump.

In this graph the ideal correction is drawn as a horizontal straight line for both resistances.

Again, whilst we do not present a statistical analysis, inspection shows that the correction is very good.

Delta-T correction

Calibrated at RH 50% 24.5°C

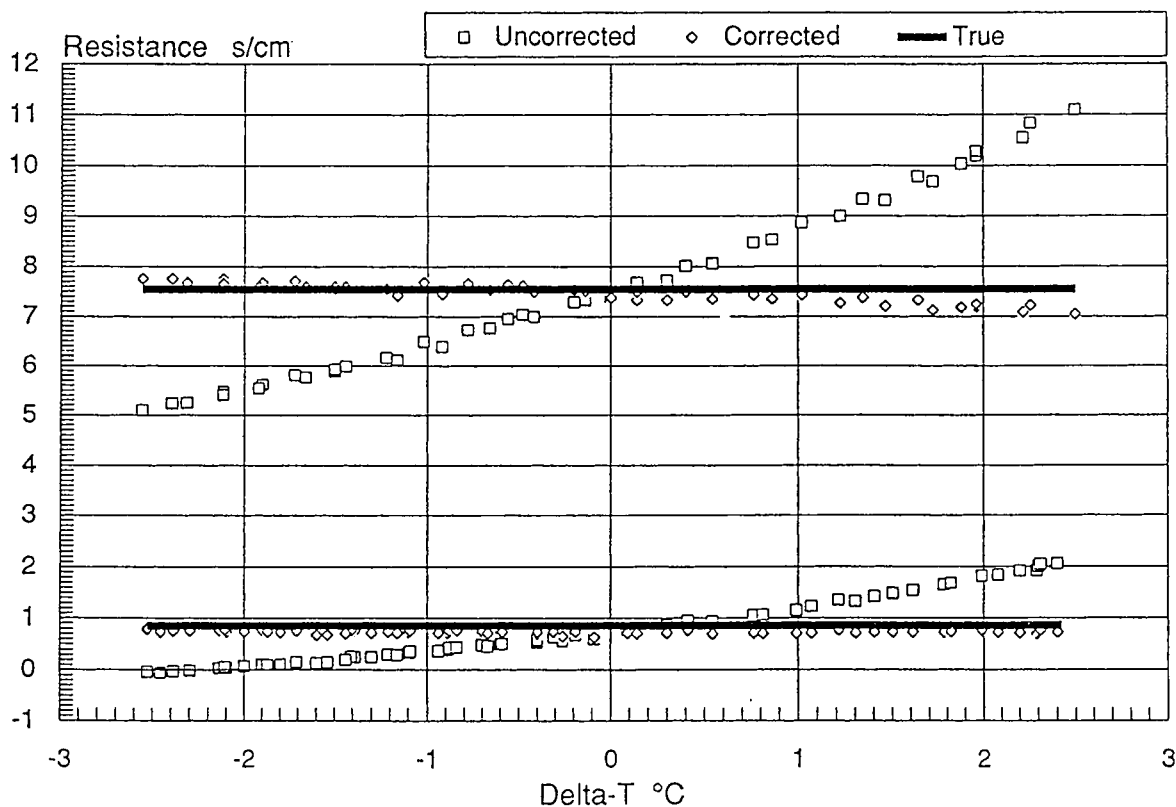

CONCLUSION

Over the whole range of calibration conditions investigated, the measured reading was within $\pm 20\%$ of the theoretical (true) resistance over the range $+10$ to -5°C for cup temperature and $\pm 2.5^{\circ}\text{C}$ for cup-leaf temperature difference away from the conditions existing at calibration.

It is important to realise that this accuracy will be compromised by poor calibration. It may well be better than this using a careful calibration.

REFERENCES

Brown H. T. & Escombe F., (1900) Static Diffusion of Gases and Liquids. *Philos. Trans. R. Soc. London, Ser B*, 193, 223-291.

Black CR (1990) *Transpiration Techniques for Groundnut and Pigeonpea in the field* Consultant's Report. University of Nottingham. Faculty of Agricultural and Food Science, Sutton Bonington, Loughborough, Leics LE12 5RD, United Kingdom

Chapman D.C. & Parker R.L., (1981) A Theoretical Analysis of the Diffusion Porometer. *Agricultural Meteorology*. 23, 9-20.

Monteith J.L., Campbell G.S., & Potter E.A. (1988) Theory and Performance of a Dynamic Diffusion Porometer. *Agricultural & Forest Meteorology*. 44, 27-38.

Monteith J.L. (1980) *Principles of Environmental Physics*. Arnold, London.

Meidner H. & Mansfield T.A. (1968) *Physiology of Stomata*. McGraw Hill, London.

Jarvis P.G & Mansfield T.A. (1981) *Stomatal Physiology*. Cambridge University Press, Cambridge.

Parkinson K.J. (1985) Porometry. In *Instrumentation for Environmental Physiology*. (Editors Marshall B. & Woodward F.I.) Cambridge University Press, Cambridge.

INDEX

Accessories, 160
Accuracy, 172, 175
Algorithms flowchart, 138

BAROMETRIC PRESSURE, 87
BATTERY, 98
Battery Charger, 8, 16, 98
Battery, warnings, 7
Baud rate, 68
Beeping, 34, 50
Brown and Escombe, 168

Calculation of results, 123
CALIBRATE SETTINGS, 48
Calibrating Light Measurement, 112
CALIBRATION, 39
Calibration curve, 178
CALIBRATION CYCLE, 50
Calibration Kit, 40
CALIBRATION LOOP, 46
Calibration plate, 79
Calibration
 summary, 56
Carbon dioxide, 89
CASE AND CHASSIS, 101
CHANGING THE CUP, 105
CHANGING THE SETTINGS, 30
Chapman and Parker, 168
CHARGING PRINTED CIRCUIT BOARD, 143
CHASSIS LAYOUT, 103
CHECKS, 72
Circuit diagram
 analogue, 146
 block, 151
 Charge PCB, 149
 digital, 147
 Forth computer, 148
 Head PCB, 152
 main PCB, 150
 TDS 9090, 148
CLEANING THE SENSOR HEAD, 83
COM2, 63
Comma Separated Values, 64
Communication error, 69
COMPONENTS & CONNECTORS, 153
Condensation, 79
CONFIGURE AP4 HEAD, 112
CONNECTION, 62
Connectors, 156
Consumables kit, 8, 159
CONTROL KEYS, 18
CONTROLLING THE AP4, 66
Controls, 13-16

CSV, 64
CTS (Clear To Send), 69
CUP : HOW TO CHANGE IT, 104
Cup length parameter, 177
CUP TEMPERATURE, 82
Cup type, 48
Cup
 Absorption, 128
 choice, 80
 Cleaning, 83
 Theory, 121
CUP-LEAF SEAL, 81
Cup-leaf temperature difference correction, 181
Current consumptions, 98
Curve error, 54
CYCLE SETTINGS, 50
CYCLE SETTINGS SCREEN DISPLAY, 34
Cycle time
 Too slow, 82
Cycling porometer, 6

δT , cup-leaf temperature difference, 34, 80
 δt_f , corrected transit time, 122, 134
 δt_m , measured transit time, 122, 134
Data bits, 68
Data format, 64
DEBUGGING, 117
DESICCANT : HOW TO CHANGE IT, 106
DESIGN OF THE AP4, 163
Double beep, 80

Electronics
 How it works, 141
EPROM : HOW TO CHANGE IT, 107
Equations, 123
Error, 54
EXAMPLE PLAN, 74
EXIT KEY, 18
EXPERIMENTAL BASIS FOR THE AP4 ALGORITHMS, 175

FAULT FINDING, 117
Ferrous sulphate, 114
Fick's law of diffusion, 86
Finite element analysis, 168
FIT CURVE, 52
Flashing display, 82
Flowchart of temperature correction algorithms, 138

Geometry of pores, 89
GO KEY, 19
Greenhouse, 79
Groundnut, 172
Group name, 32
Guard cell, 89

HANDSHAKING, 69
HEAD : HOW TO DISASSEMBLE, 110
Head
 Layout, 14
 Theory, 121
 Warnings, 7
HELP KEY, 18
HINTS AND TIPS, 78
HOW IT WORKS, 119
HOW MANY READINGS TO TAKE, 73
HOW THE ELECTRONICS WORK, 141
HOW TO CALCULATE AVAILABLE MEMORY, 75
HOW TO DRIVE THE POROMETER, 13
HOW TO READ, 29
HOW TO SERVICE, 97
HOW TO TAKE READINGS, 27
Hypostomatous leaf, 82

INSERT LEAF, 33
INSERT LEAF SCREEN DISPLAY, 32
INSERT PLATE, 48, 52
INSTALL CALIBRATION, 54
INSTALLING THE DATA RETRIEVAL SOFTWARE, 63

Jam sandwich, 74
Jumpers, 69
KEYBOARD, 16

L, cup length parameter, 177
LEAF HANDLING, 80
LEAF TEMPERATURE, 81
Leaf name, 32
Lid ribbon cable, 159
LIGHT SENSOR, 82
LIGHT SENSOR : CALIBRATION, 112
Liquid crystal display, 159

MAIN PRINTED CIRCUIT BOARD, 142
Mark 3 porometer, 172, 178
MEASUREMENT, 28
Memory, 10
MEMORY USAGE, 73
Memory
 How many readings to take, 73
MENU NAVIGATION, 23
MINUS KEY, 21
MODELLING CALIBRATION PLATE PERFORMANCE, 168
MODELLING OF CUP PERFORMANCE, 164
MONTEITH ET AL EQUATION FOR TRANSIT TIME, 126

OFF KEY, 18
ON KEY, 18
Operating principles, 119
OPTIONAL ACCESORIES, 8
Order, 48
OUTPUT, 61

Packing list, 8, 9
PAR sensor, 82

Parallel port, 66
Parity, 68
Parts list
 Accessories, 160
 Consumables, 159
 electronic components, 153
 Spares, 159
Pigeonpea, 172
PLANNING YOUR EXPERIMENT, 71
Plant' name, 32
PLUS KEY, 21
Pollutants, 10
POROMETRY AND STOMATA, 89
Position, 48
Postscript, 66
POWER RAILS, 144
POWER SUPPLIES, 144
PREPARATION, 27, 40
PREPARING YOUR COMPUTER, 63
Pressure, 34
PRESSURE AND TEMPERATURE DEPENDENCE, 86
PRINT OUT, 33
PRINTER WON'T PRINT?, 66
PRINTING DIRECT TO A PRINTER, 66
Protection, 10
PUMP : HOW TO CHANGE IT, 111
Pump Assembly, 159

QWERTY keyboard, 16
Quick Guide, 25

READ, 29
READING CYCLE, 34
READING LOOP, 30
READINGS CYCLE SCREENS, 35
READINGS SETTINGS SCREEN DISPLAY, 32
RECONSTITUTION OF CRYSTALS, 106
REFERENCES, 183
REPAIRS, 117, 141
RESISTANCE & CONDUCTANCE UNITS, 85
Resistance
 High, 82
RETRIEVE 2, 63
REVIEW, 57
RH calibration, 113
RH Head, 48
RH sensor, 83
RH Sensor
 calibration, 113
 circuit, 142
 Cleaning, 83
 warnings, 7
RH Set, 32, 48, 79
RS232
 settings, 68
RUNNING THE SOFTWARE, 63

SATURATED VAPOUR PRESSURE, 131
SCROLL KEY, 20

SENSITIVE STOMATA, 80
SENSOR HEAD, 142
SENSOR HEAD
 Cleaning, 83
SERVICE AND GUARANTEE, 161
Servicing, 141
SET KEY, 21
SETTING UP AND SHUTTING DOWN, 10
SHIFT OFF (together, 20
SHUTTING DOWN, 10
Silica gel crystals, 106
Sleep consumption
 when the AP4 is switched off, 98
SOFTWARE CRASHES, 116
Spare sensor head, 160
Spares, 159
SPECIFICATIONS, 93
STANDARDISED PRESSURE SETTING, 87
Stomata, 6
Stomatal pores, 89
Stop bits, 68
STORAGE, 99
STORE READINGS, 36
STORE READINGS SCREENS, 37
STORE SETTINGS SCREEN, 36

TDS 9092 MICROPROCESSOR CARD, 143
TECHNICAL SECTION, 91
Temperature correction
 algorithms, 138
 validation, 175, 180
Temperature dependance of cup water absorption, 179
TEMPERATURE MANAGEMENT, 81
Temperature
 correction, 123
TEST RESULTS, 171, 172, 175
Text, 64
Theory, 121, 123
Theory
 RH sensor, 134
 saturated vapour pressure, 131
 vapour pressure gradient, 132
Thermistor, 14, 115
Time constant, 134
Transmission interrupted, 64
TROUBLE SHOOTING, 117
TUTORIAL, 77

Units, 32, 34, 48, 85
UNPACKING AND INSTALLATION, 8

Validation, 172, 175
VAPOUR PRESSURE GRADIENT CORRECTIONS, 132
Verification, 172

WARNINGS, 7, 29
Water absorption by cup walls, 177
WETTING THE FILTER PAD, 42
WHAT HAPPENS IN THE HEAD, 121

WHAT HAPPENS ON YOUR COMPUTER SCREEN, 64

Wiring

 connectors, 156

WOOD'S EQUATION FOR CUP ABSORPTION, 128

Wood's equations for L, 175

AP4 RETRIEVE FOR WINDOWS SOFTWARE

DISKETTE

The AP4 is supplied with data retrieval software diskettes. The following information covers only the Windows software, which is now recommended. For the original DOS software, please refer to section 6.6 OUTPUT.

The software is also available for free download from the Delta-T website.

REQUIREMENTS

You will need a PC running Windows 98 or later, with a floppy disk drive, and an RS232 port. If your PC does not have an RS232 port, but does have a USB port, you must obtain a USB to RS232 adapter suitable for your version of Windows.

TO INSTALL THE SOFTWARE

From the floppy disk:

Read the Readme.txt file on the floppy disk.

This may contain more recent important information that you should comply with.

Then Run A:\Setup.exe

From a website download:

Run the downloaded .exe executable file.

TO RUN THE AP4 RETRIEVE SOFTWARE

After installation, run the AP4.exe file from the folder in which you installed the program.

You can create a desktop shortcut to this file, if you wish.

You should get the following screens, which are largely self-explanatory.

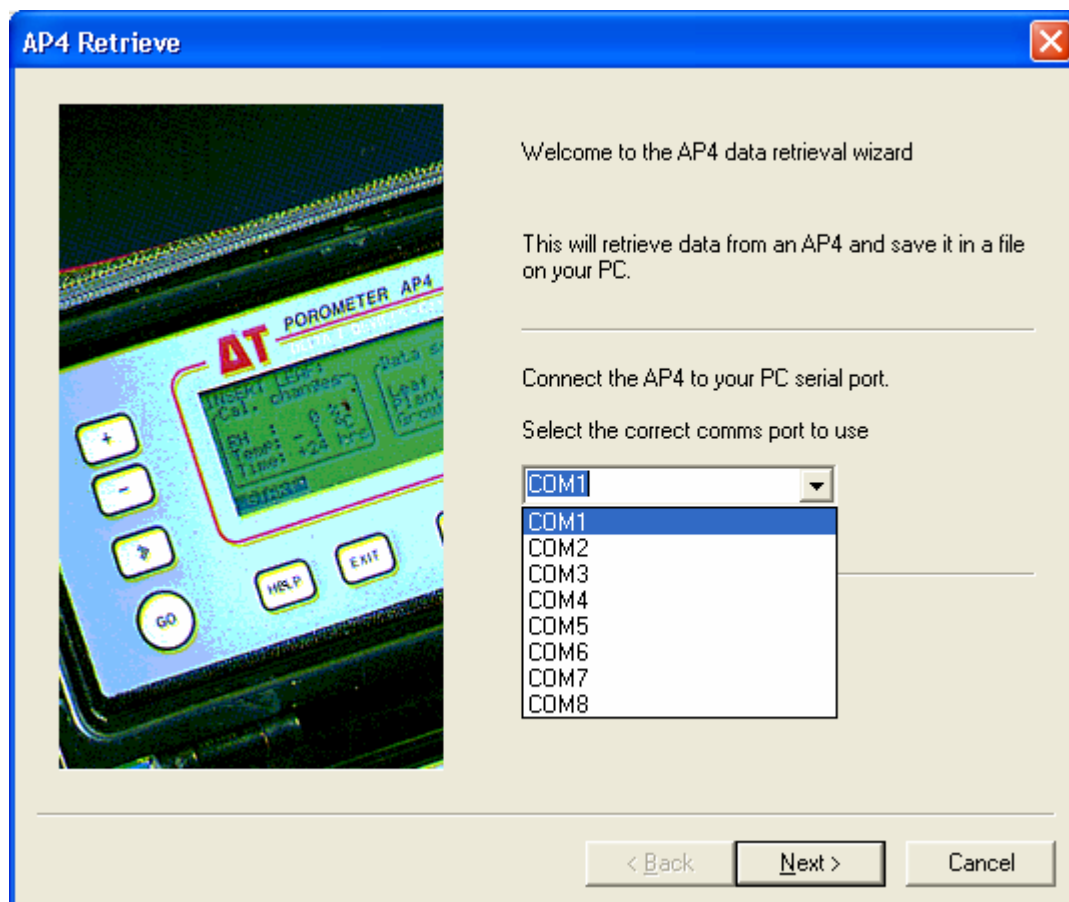

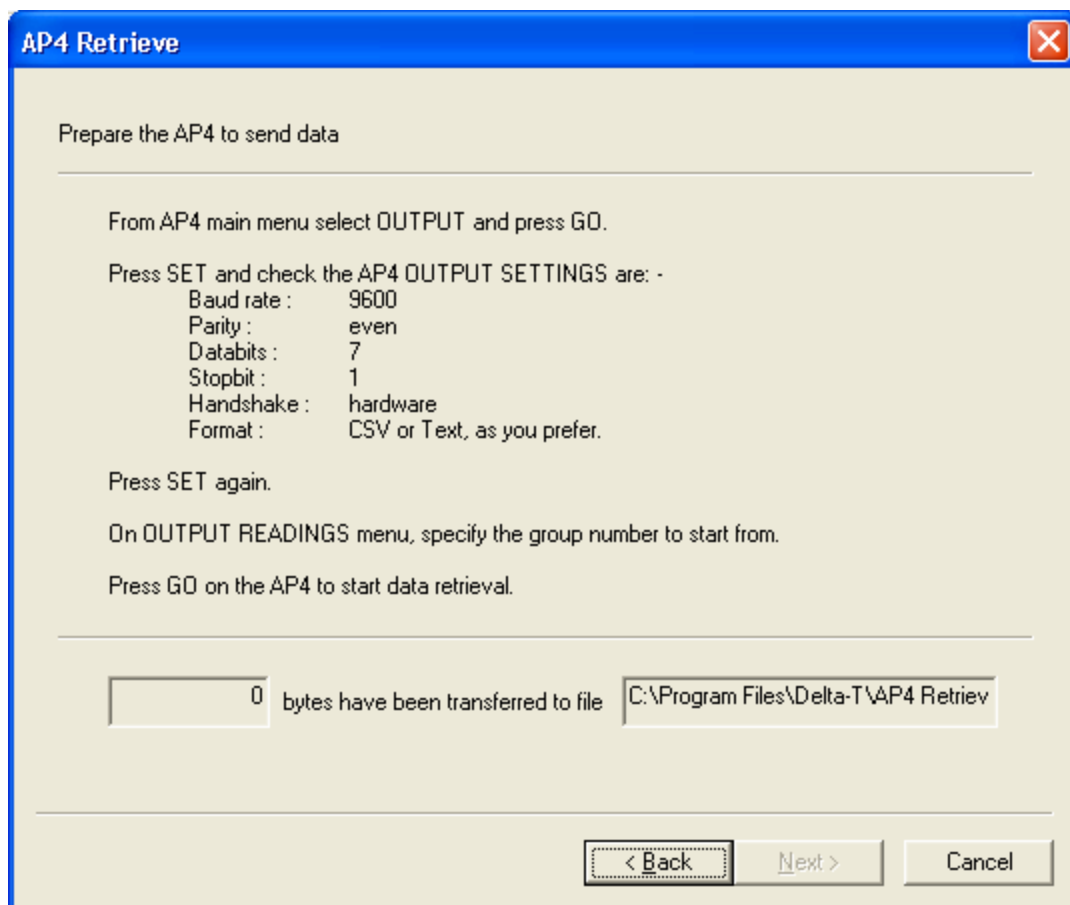
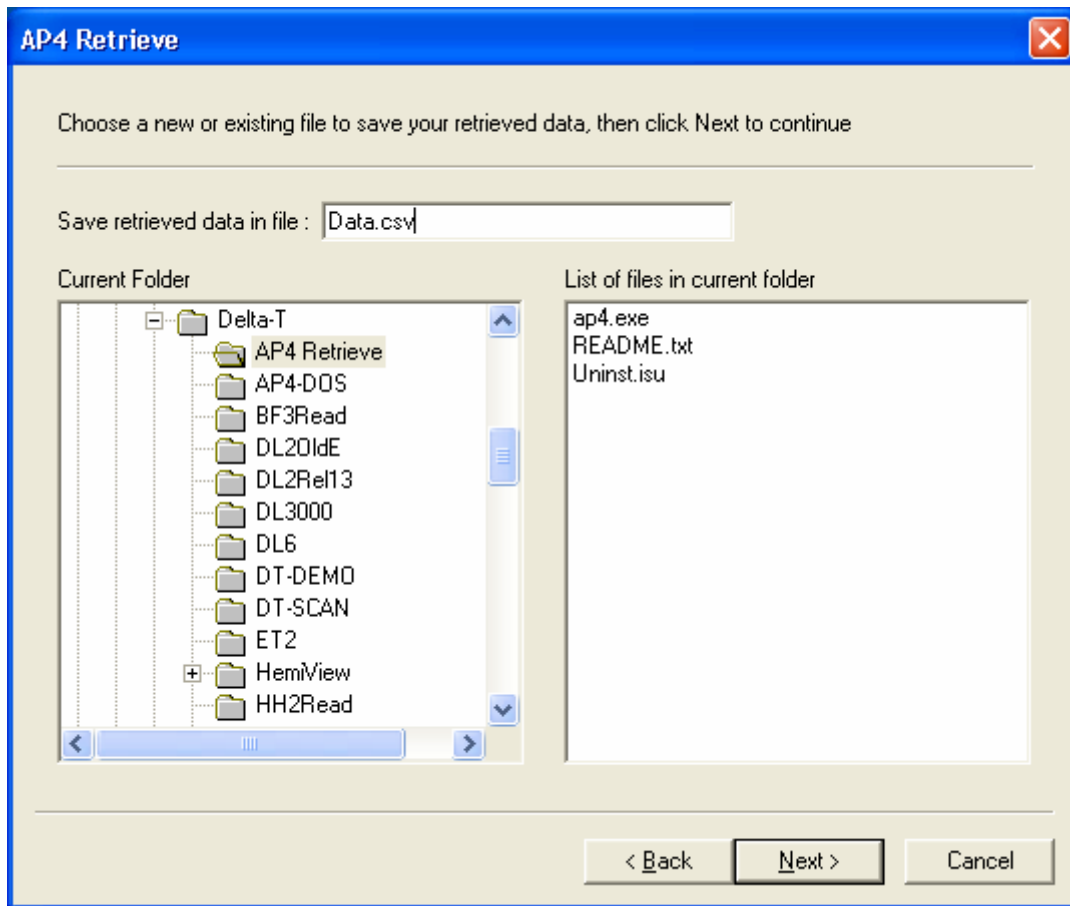

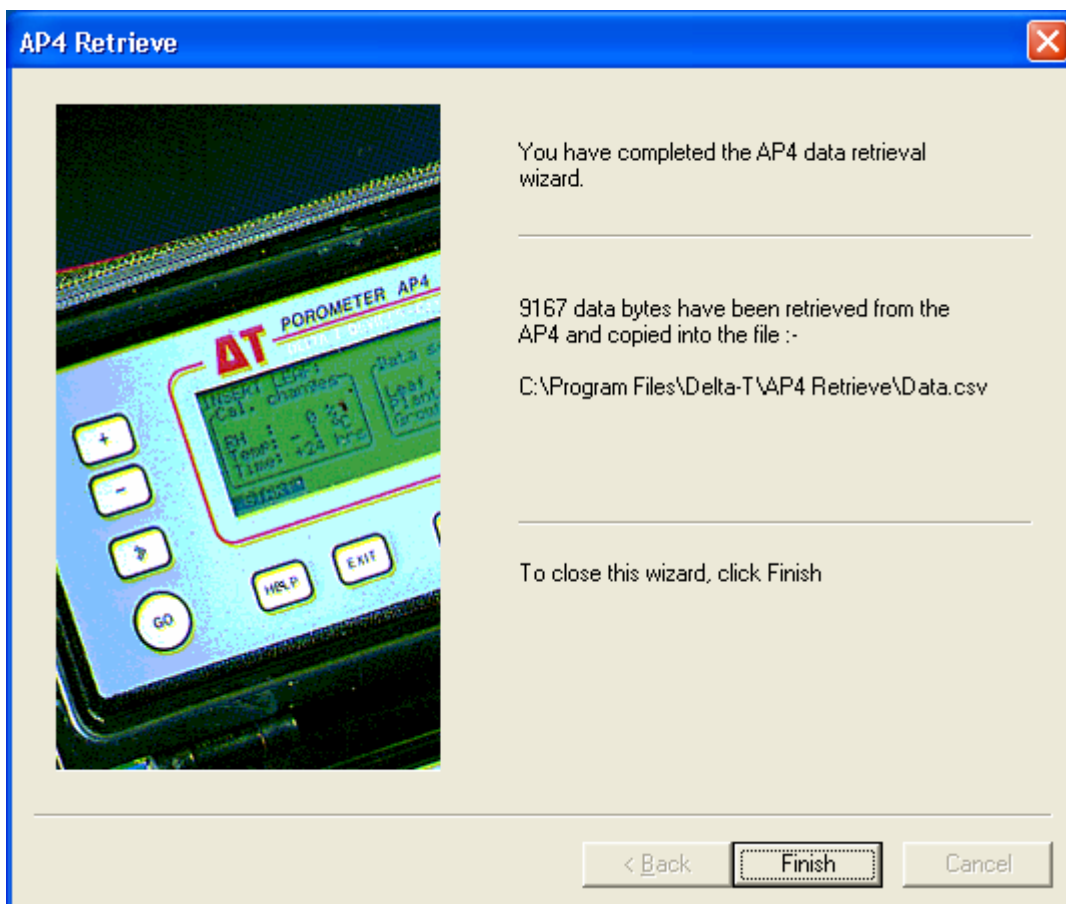
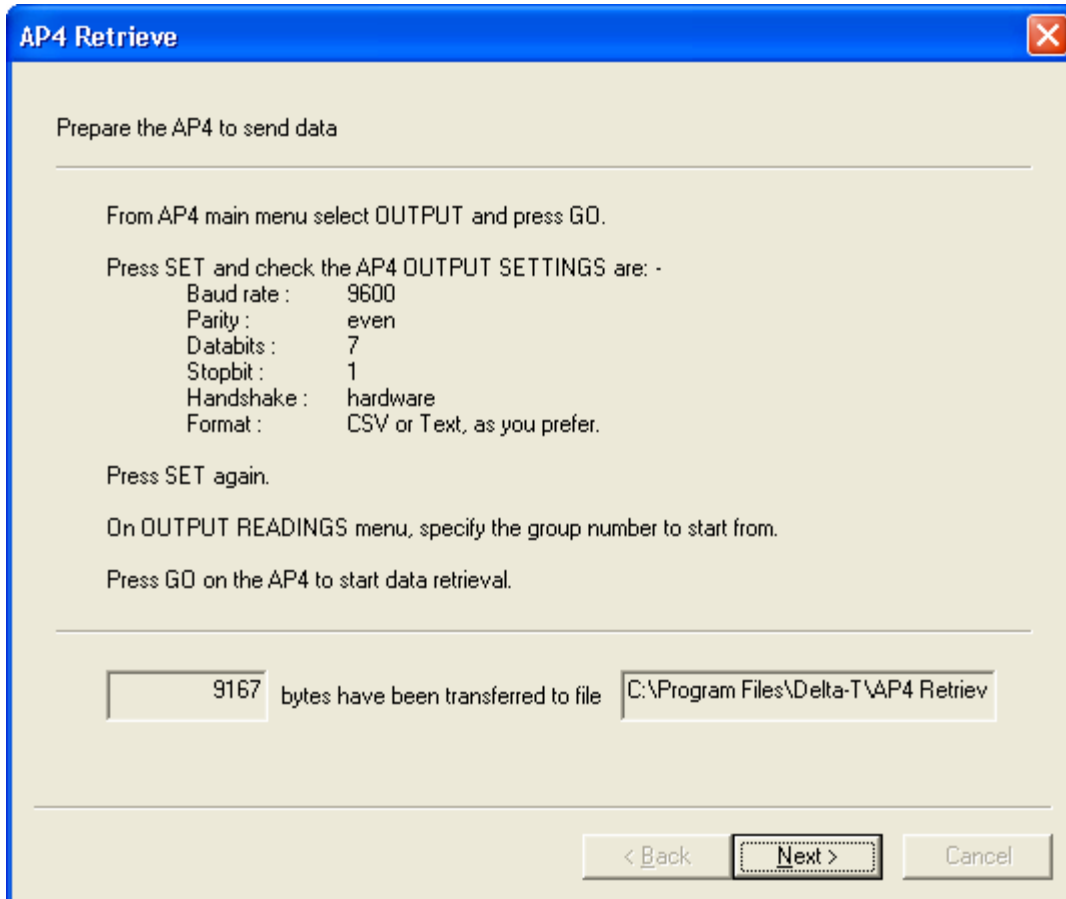

This page is intentionally blank.

APPENDIX D AP4 HEAD DESIGN DETAIL

AP4 HEAD MOULDING IMPROVEMENTS

From January 2004, new AP4 Porometer heads incorporate detail design changes to improve the ergonomic handling, and to reduce the wear and tear experienced after prolonged use. These improvements are derived from many years of experience with AP4 porometers which have been employed in a wide variety of field situations.

The main features are highlighted below. The new mouldings are immediately recognisable from the finger grip mouldings and the Delta-T name. New tooling has been produced to increase the consistency of manufacture of the cup and leaf pad gaskets and seals.

The functionality of the AP4 head is not changed, and it will show increased life and durability in field use.

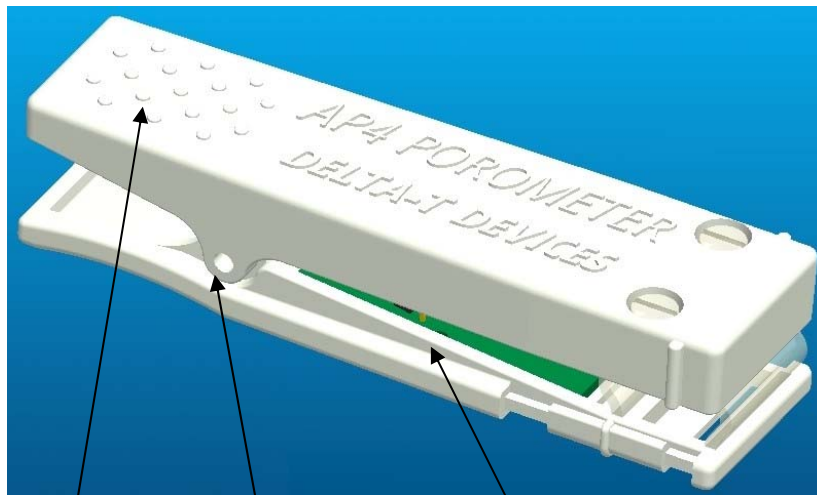

Finger grip moulding

Improved hinge pin and alignment

Reinforcement webs to increase rigidity

Improved cable strain relief

Cup and leaf seals improved



This page is intentionally blank.

APPENDIX E AP4 BATTERY DESIGN CHANGE**AP4 BATTERY CHANGE**

From mid 2004, a new battery design is incorporated. The new battery has superior capacity and life compared with the original battery. The position of various internal components is changed, as illustrated below.

When referring to section 10.1 BATTERY from page 98, you should interpret the instructions taking into account the new physical arrangement.

The instructions regarding operating care and maintenance of batteries remain the same.

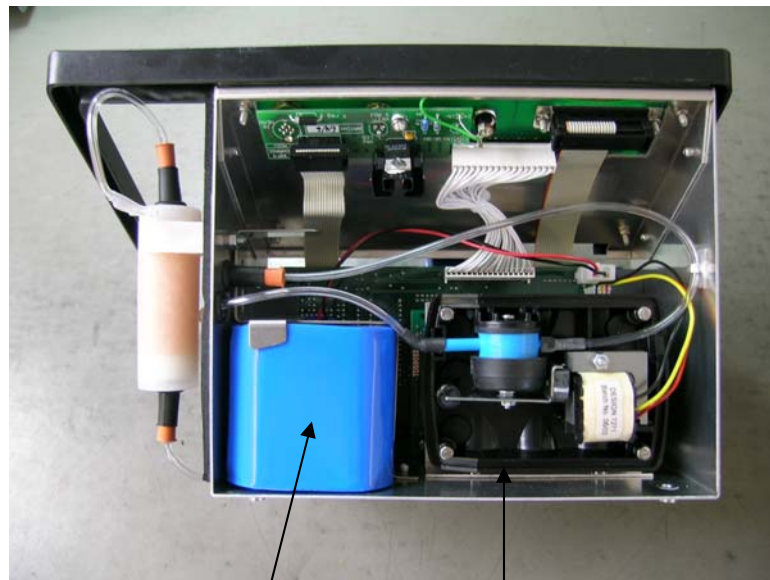

Original battery position

Pump original position

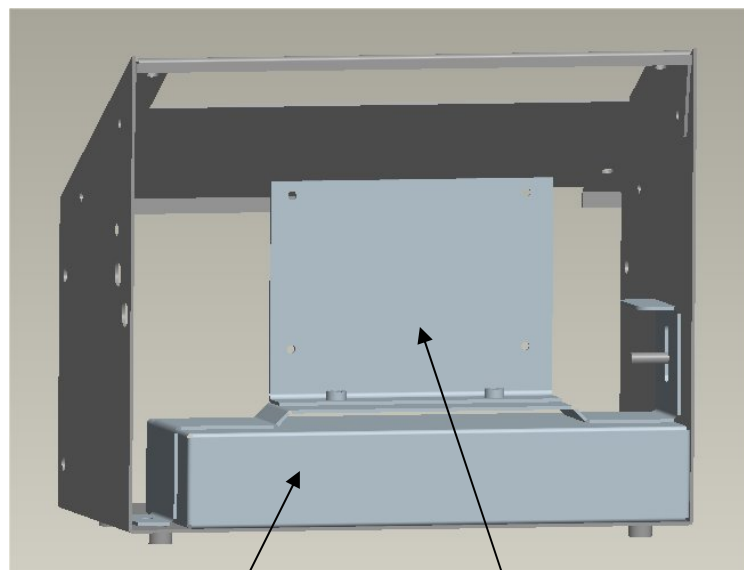

New battery position

Pump new position