

BF5 Sunshine Sensor

Total (Global) and Diffuse Radiation and Sunshine Duration sensor needing no routine adjustment or polar alignment.

Quick Start Guide version 1.0



AT Delta-T Devices Ltd

Overview

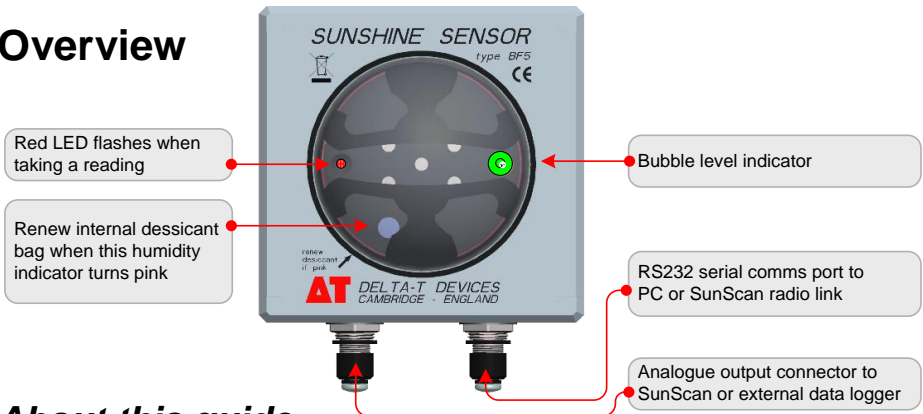

About this guide

This shows how to set up, connect to and obtain readings from the BF5.

See also: [BF5 User Manual](#) (in print and pdf)

PDFs can be found on the [Software and Manuals CD](#) and online at www.delta-t.co.uk

Unpacking













The BF5 is supplied in a foam-lined box with

- RS232 serial cable [SP-BF-RS01](#)
- [BF5 User Manual](#) and this Quick Start Guide
- Calibration certificate
- Delta-T [Software and Manuals CD](#)

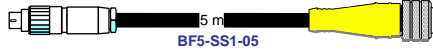
Optional Accessories

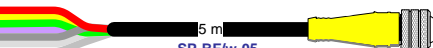
- Telescopic tripod [BFT1](#)
- BF5 cross arm [BF5-M](#) →

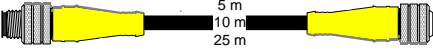

| CABLE OPTIONS | | BF5 end |
|------------------------|--|---|
| RS232 cable | 9-way serial female   1.5 m SP-BF-RS01 | 5-way M12 female  |
| RS232 extension cable | 5-way M12 male   10 m SP-BF-RS10 | 5-way M12 female  |
| SunScan cable | 5-way male   5 m BF5-SS1-05 | 8-way M12 female  |
| Logger cable | Flying leads   5 m SP-BF/w-05 | 8-way M12 female  |
| Logger extension cable | 8-way M12 male   5 m 10 m 25 m EXT/8w-5 EXT/8w-10 EXT/8w-25 | 8-way M12 female  |

BF5 system wiring options

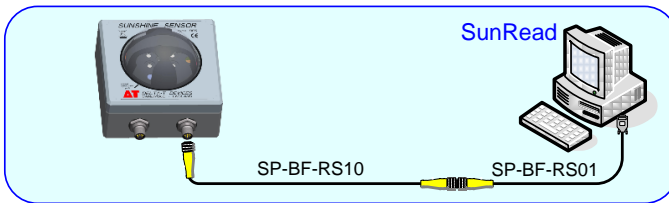

BF5 serial port
to PC
running SunRead

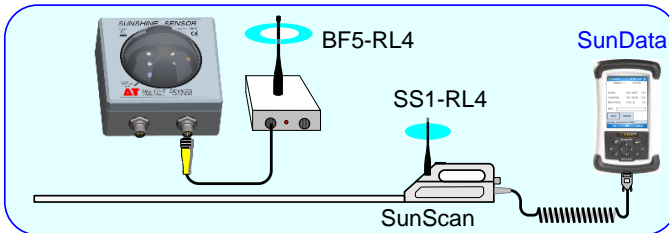

BF5 serial port
to BF5-RL4 radio link
...to SunScan
(fitted with
SS1-RL4Radio Link)
to PDA
running SunData

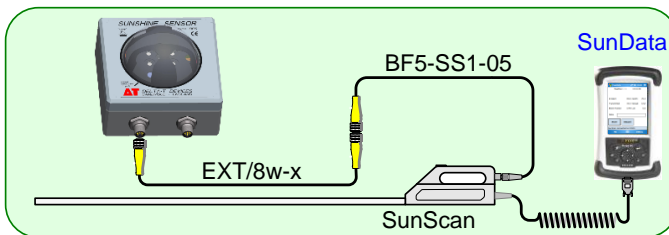

BF5 analogue
port to SunScan
to PDA running
SunData

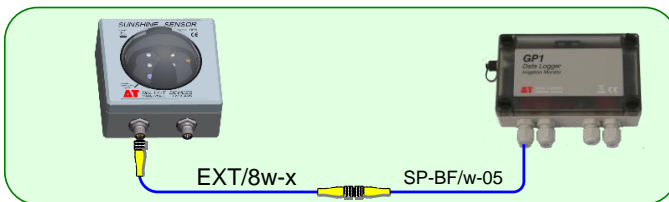

BF5 analogue
port to
GP1 Logger

(Then serial link from
GP1 to PC or PDA
running DeltaLINK)

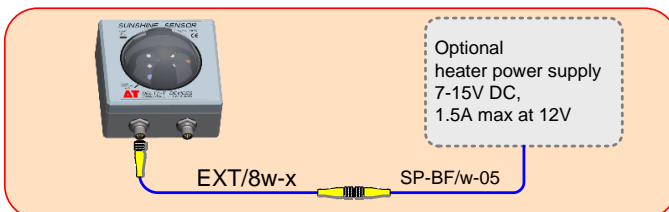

Analogue cable
SP-BF/w-05
can provide sensor
“warm-up” power
from the logger for
analogue readings

It also has 2 wires for
optional heater power

Simple BF5 use with SunRead

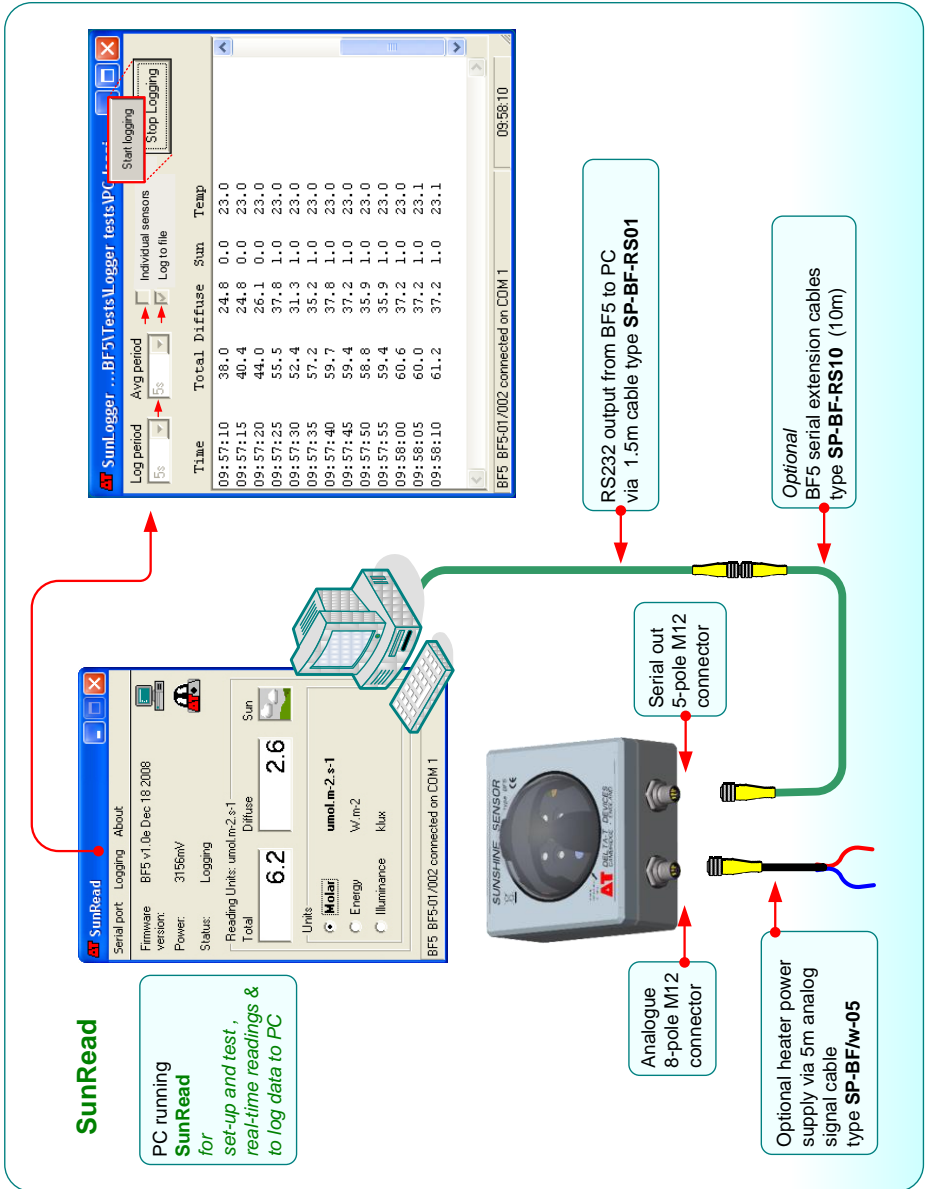

BF5 logging using an external logger

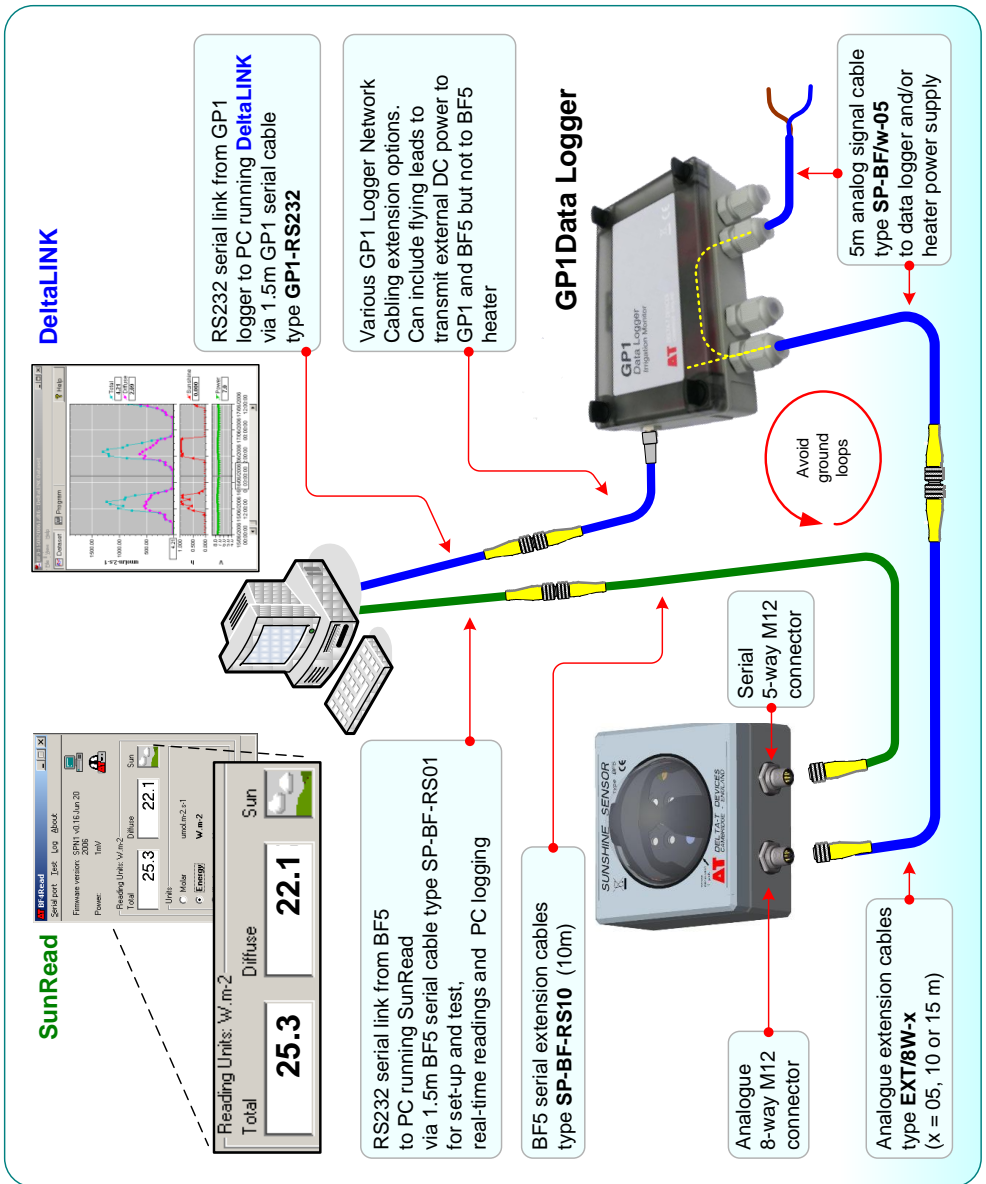

Power connection options



Optional
Internal
3V alkaline
batteries

Battery power



Mains-powered power supply
7-15V DC, 1.5A max at 12V,
outputs isolated from mains

Htr+ Htr-

SP-BF/w-05

Heater power

(To enable analogue outputs connect the separate logger warmup line - see below)



Warm up control:
>3V required for BF5 to provide its output signals, if power is provided elsewhere and/or

External sensor power:
5-15V @ 2mA recommended to power sensor via warm-up line

DL-Power DL-Gnd

SP-BF/w-05

Power via logger warmup.

Analogue outputs enabled.
No heater.



BF5 power from PC's RS232 serial port (draws up to 2mA from the RS232 DTR line if no other power available)

Note: some laptops may not provide enough current

SP-BF -RS01

Power from PC

Heater cable wiring

Heater use is optional. Connect the red (Htr+) and blue (Htr-) wires to a 12V DC 1.5A power supply. The heater current depends on the temperature. In cold climates a 40Ah battery only lasts one day, so use a mains-powered regulated 12V DC power adaptor.

Do not apply AC mains power to the BF5. Isolate heater power supply from other BF5 wiring connections - do not share it with the common ground.

Install the BF5 on site

The BF5 may be installed at **any latitude** and at **any polar angle** i.e.relative to North. Mount the BF5 **horizontally**; checking the bubble is centred in the bubble level.

If used with **SunScan** for above-plant-canopy reference measurements, the BF5 should be close to, or above, the position of the SunScan probe.



Illustration showing use of a BF5 mounted above a crop on a tripod along with a SunScan Radio Link

Mount the BF5 to a camera tripod if using it close to, or above low field canopies (i.e. up to about 1.8m). Use the camera tripod socket in its base.

Above this height the **BF5-M** (1m x 32mm) cross-arm adaptor may be useful. It includes a Manfrotto type 482 camera adaptor and a KeeKlump type 45-86 connector. This is compatible with the Delta-T M2 weather station mast and with many building scaffolding systems.



Alternatively the BF5 may be mounted using holes (for M4 bolts) located at the four corners at the base of the box. These are accessed by opening the BF5 via the four screws in the lid. You will have to provide something to support and hold the BF5 level.

Levelling

The BF5 is equipped with a miniature bubble level. The tripod **BFT1** has 3-axis adjustment to facilitate levelling. The sensor is level when the bubble is within the central circle.

It is more important to level the BF5 accurately, than the SunScan probe.

SunRead PC software

These run on a PC connected directly to a BF5 via an **SP-BF-RS01** RS232 serial cable.

About SunRead

- **Displays Total (global) and Diffuse radiation and sunshine status**
- **Use for *setting up and testing* BF5**
- **Real-time Readings**
- **Log data directly to PC**

Software Installation Requirements:

- PC running Windows XP, Vista and 7
- One free RS232 serial port, or USB-RS232 adapter
- CD-ROM drive for software installation
- RS232 cable **SP-BF-RS01**
- **Delta-T Software and Manuals CD** version 3 or later
- Acrobat Reader for reading documentation (free download from www.adobe.com)

Software Installation

1. Install the CD in the PC. On most PCs, installation will start automatically. If it does not, run the file setup.exe in the root folder of the CD. This will display an index of software and also of documents.
2. Click on **Install SunRead software**.
3. Check the CD and also our website at <http://www.delta-t.co.uk/support.html> for the latest documentation and copy it to your PC if you wish.

For further installation information see **SunRead Release Notes** on the CD.

Start SunRead

1. Connect your BF5 to a spare serial port (or via a USB-RS232 adapter) to your PC, using the **RS232** cable plugged into the 9 way D connector - see **Overview** diagram.
2. Run **SunRead** to display the screen shown below.

The screenshot shows the SunRead application window with the following callouts:

- Select from the available serial ports:** Points to the 'Serial port' dropdown menu.
- Set up data logging to PC:** Points to the 'Logging' tab.
- Software version number:** Points to the 'About' tab.
- Firmware version reported by BF5:** Points to the 'Firmware version: BF5 v1.0e Dec 18 2008' field.
- Battery voltage if batteries are fitted, otherwise external power supply voltage:** Points to the 'Power: 3156mV' field.
- Logging status:** Points to the 'Status: Logging' field.
- Total & Diffuse readings, updated every 2s. Icon shows sunshine state:** Points to the 'Total: 6.2' and 'Diffuse: 2.6' fields and the 'Sun' icon.
- Select BF5 output units. Selecting different units changes BF5 analogue output scaling:** Points to the 'Units' section where 'Molar' is selected.
- Sensor type, serial number and connection status:** Points to the bottom status bar: 'BF5 BF5-01/002 connected on COM 1'.

Logging to PC with SunRead

1. Select **Logging**, **Log to PC** to display the PC logging window.
2. Enter the logging options (see below)
3. Click **Start Logging**.

Logged data is displayed in real-time, and can be saved to file as .csv or text files and graphed in Excel.

The screenshot shows the SunRead Logger window with the following callouts:

- Start logging:** Points to the 'Start logging' button.
- Stop Logging:** Points to the 'Stop Logging' button.
- Time:** Points to the first column of the data table.
- Total:** Points to the second column of the data table.
- Diffuse:** Points to the third column of the data table.
- Sunshine status:** Points to the fourth column of the data table.
- BF5 Temperature:** Points to the fifth column of the data table.

| Time | Total | Diffuse | Sunshine status | BF5 Temperature |
|----------|-------|---------|-----------------|-----------------|
| 13:17:40 | 83.9 | 23.5 | 1.0 | 27.9 |
| 13:17:50 | 127.8 | 31.9 | 1.0 | 27.9 |
| 13:18:00 | 122.9 | 32.2 | 1.0 | 27.9 |
| 13:18:10 | 42.2 | 22.3 | 1.0 | 27.9 |

Logging options

Log period: sets logging frequency.

Avg period: sets averaging period.

Log to file: saves each reading to file as it is logged.

Individual sensors: records all 7 individual light sensors.

Use with SunScan

Connect the BF5 to **SunScan Probe** with cable **BF5-SS1-05**
 See also the **SunScan Quick Start Guide** and **SunScan User Manual**.

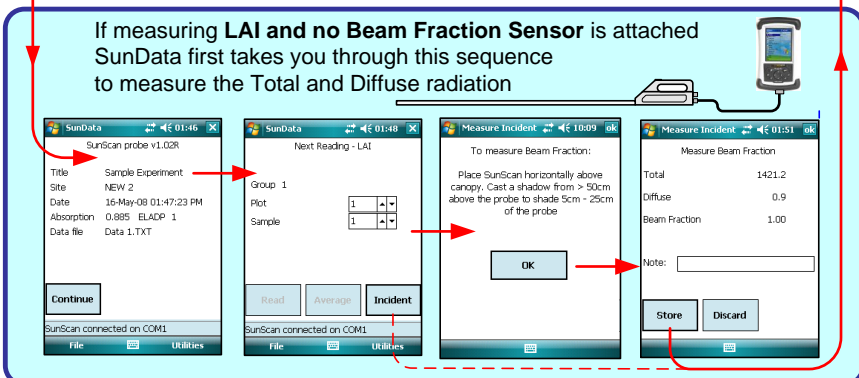
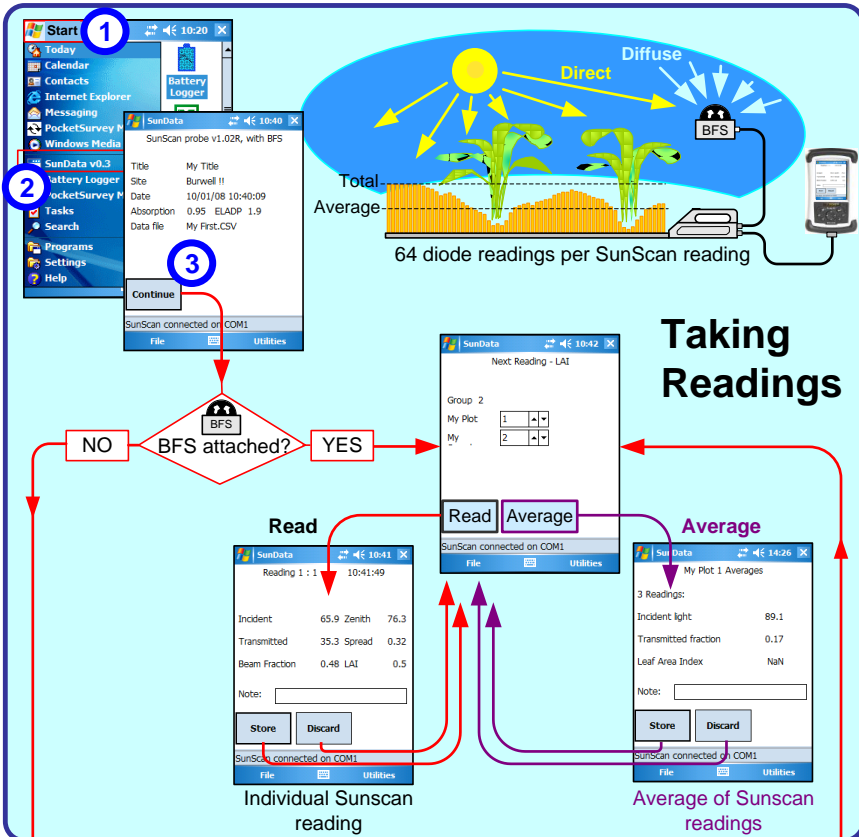

Use with an external Data Logger

Outputs

The analogue connector provides voltage outputs for Total (global) and Diffuse radiation, plus a digital output for sunshine state.

It is suitable for recording by many data loggers via cable **SP-BF/w-05**.

The **GP1** Logger is particularly suitable.

Connect analogue cable to logger

Connect the colour coded flying leads on the analogue output cable **SP-BF/w-05** to a data logger, **preferably with differential inputs**, such as the GP1 - as shown below.

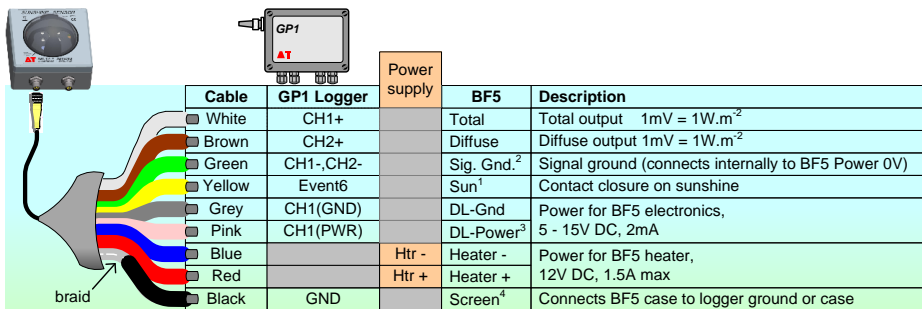

White: (Total output) and **Brown:** (Diffuse output): connect to data logger voltage inputs. The normal range of this output is 0V – 1.3V

Green: connect to data logger signal ground or –ve input terminal. (See Note 2)_

Yellow: connect to a data logger digital input. It gives a short circuit to ground when sunshine is present, and open circuit with no sunshine. (See Note 1)

Alternatively, connect to a resistance input, with a precision resistor in parallel.

Grey: connect to data logger power ground.

Pink: connect to data logger power +5 to15V DC (See Note 3)

Blue 0V and **Red V+:** apply 7-15V to power the Heater

Screen: Connect to logger frame. (See Note 4)

Footnotes

Note 1: The Sun state output is an open collector. The signal return for this output is the Power 0V line. This output may sometimes be used with analogue channels. The implied signal return is then analogue channel signal ground.

Note 2: To prevent earth loops causing noisy readings or small voltage offsets, avoid connecting this wire with Power 0V at the logger.

Note 3: This wire has two functions:

a) Warm-up control. > ~3V must be applied to enable the BF5 circuit to provide its analogue output signals.

b) Power will be supplied to the BF5 through this wire, if the voltage exceeds ~4V, and if no other power source with a higher voltage is available to the BF5.

Note: To prevent power being supplied through this line include a 10 kΩ resistor in series with it.

Note 4: Analogue cables **SP-BF/w-05** and **EXT/8w-x** and serial cables **SP-BF-RS01** and **SP-BF-RS10** braids are earthed via the connector shells to the BF5 case and terminate at the data logger or PC case or ground.

To avoid ground loops do not interconnect braids elsewhere.

Note 5: To help avoid possible signal errors caused by an incorrectly isolated heater power supply, we recommend you use a data logger with differential sensor inputs – such as the GP1.

Note 6: Avoid simultaneous connection of serial cable to a PC and analogue outputs via a logger to a PC - it may create an earth loop which may reduce analogue signal accuracy.



For further information see the **BF5 User Manual**

DL2e logger users: see the **BF5 User Manual**.

Program Logger: Example using a GP1

About DeltaLINK-PC software

- **Programs the GP1 logger, starts and stops logging, displays real-time graphs, retrieves, graphs and displays logged data.**
- Runs on your PC, connected to GP1 via cable **GP1-RS232**
- Includes a BF5 logging program
- Also available as a Pocket PC version.

You need **DeltaLINK** version 2.2 or later installed along with the Excel Dataset Import Wizard: (see **Software and Manuals CD**)

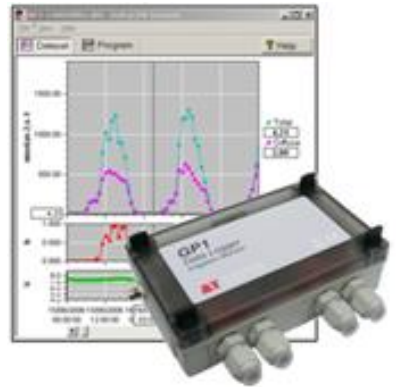

Run DeltaLINK-PC

1. Connect PC to the GP1 with cable **GP1-RS232** either using a spare serial port or USB-RS232 adapter.
2. Run **DeltaLINK**. The GP1 should respond, populating the DeltaLINK **Logger** page with status information about the logger.
3. Click on **Program** and then **Change** to create a new logging program.
4. Select **Edit, New Program** and select **BF5 Sunshine Recorder** from the list of available program types.
5. Define the logging program you require, from the options as shown.
6. Click **Apply** to install the program in the GP1.

Sample Rate: the interval between sensor readings.

Recording rate: the interval between recorded values, i.e. the integration period.

Record irradiance as: select the method of recording irradiance.

Record sunshine as: select the method of recording sunshine duration.

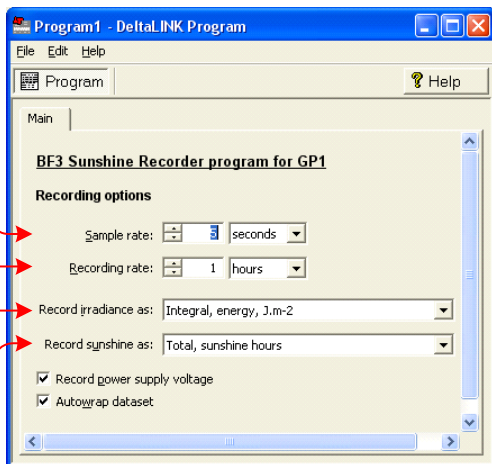

7. Click on the **Sensors** page and **Refresh** to show a real-time graph of Total (Global), Diffuse and sunshine status – to check everything seems to be working.
8. On the **Logger** tab select **Start** to start logging.
9. Periodically in the **Dataset** tab select **Refresh** to inspect logged data.
10. **Save** it to file and in Excel use **File, Import** to run the **Dataset Import Wizard** to import and graph your data.

Maintenance

See also: Routine Maintenance in the [BF5 User Manual](#)

Cleaning

- Keep glass dome clean using clean water with mild detergent or Isopropyl Alcohol.
Other solvents may damage the acrylic dome.

Environmental and Moisture protection:

The BF5 is designed to resist dust and water jets (to IP65).
To avoid internal condensation:

- Check the desiccant indicator every 3 to 6 months.
If pink replace the internal desiccant.
- Protect the heater power supply from moisture

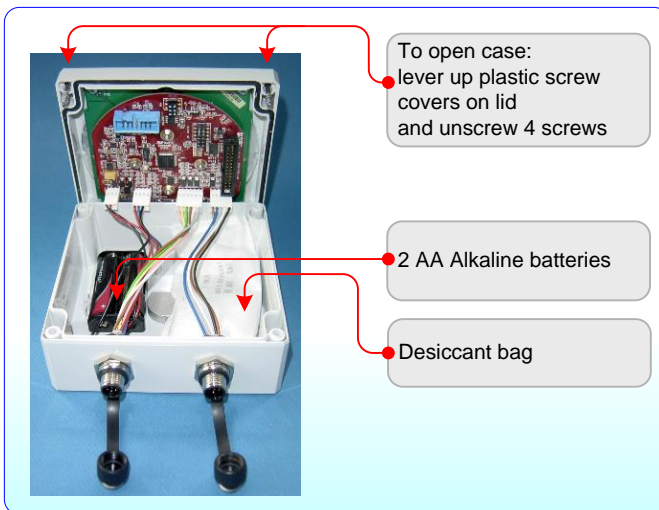

Batteries

The internal 2 AA batteries should last ~12 months, depending on the logging frequency.

Notices:

The Sunshine Pyranometer is protected by patents EP1012633 & US 6417500.
EMC certification: refer to the BF5 Regulatory Information on the [Delta-T Software and Manuals CD](#).

Specifications

The following accuracy figures give 95% confidence limits, i.e. 95% of individual readings will be within the stated limits under normal climatic conditions.
For full specifications see [BF5 User Manual](#)

| | PAR $\mu\text{mol.m}^{-2}.\text{s}^{-1}$ | Output setting Energy W.m^{-2} | Illuminance klux |
|--------------------------------|---|---|--------------------------------|
| Overall accuracy: Total | $\pm 10 \mu\text{mol.m}^{-2}.\text{s}^{-1}$ $\pm 12\%$ | $\pm 5\text{W.m}^{-2}$ $\pm 12\%$ | ± 0.600 klux $\pm 12\%$ |
| Overall accuracy: Diffuse | $\pm 10 \mu\text{mol.m}^{-2}.\text{s}^{-1}$ $\pm 15\%$ | $\pm 20\text{W.m}^{-2}$ $\pm 15\%$ | ± 0.600 klux $\pm 15\%$ |
| Resolution | $0.6 \mu\text{mol.m}^{-2}.\text{s}^{-1}$ | 0.3W.m^{-2} | 0.060 klux |
| Range | $0\text{-}2500 \mu\text{mol.m}^{-2}.\text{s}^{-1}$ | $0\text{-}1250 \text{W.m}^{-2}$ | $0\text{-}200$ klux |
| Analogue output sensitivity | $1\text{mV} =$ $1 \mu\text{mol.m}^{-2}.\text{s}^{-1}$ | $1\text{mV} =$ 0.5W.m^{-2} | $1\text{mV} =$ 0.100 klux |
| Analogue output range | $0\text{-}2500\text{mV}$ | $0\text{-}2500\text{mV}$ | $0\text{-}2000$ mV |

Other specifications

| | |
|--------------------------------------|---|
| Accuracy: Sunshine status | $\pm 10\%$ sun hours with respect to the WMO definition |
| Accuracy: Cosine Correction | $\pm 10\%$ of incoming radiation over $0\text{-}90^\circ$ Zenith angle |
| Accuracy: Azimuth angle | $\pm 5\%$ over 360° rotation |
| Temperature coefficient | $\pm 0.15\%$ / $^\circ\text{C}$ typical |
| Temperature range | -20 to $+50^\circ\text{C}$ with Alkaline batteries -20 to $+70^\circ\text{C}$ with Lithium batteries |
| Stability | Recalibration recommended every 2 years. |
| Response time | < 250 ms |
| Spectral Response | $400\text{-}700$ nm (see graph in BF5 User Manual) |
| Latitude capability | -90° to $+90^\circ$ |
| Environmental: Sealing | IP65 (shower and dust proof) |
| Sunshine status output | No sun = open circuit. Sun = short circuit to ground |
| Internal Battery | $2 \times 1.5\text{V}$ AA Alkaline batteries |
| Power requirement | 2 mA (awake), <30 μA (asleep) |
| Battery lifetime | 1 year typical |
| Input Voltage Range if | 1.4 to 3.6V DC powered from internal batteries |
| Input Voltage Range – external power | 5 to 15V DC |

| | |
|--|--|
| Fuse trip point on sunshine status signal | 0.5A, 30V (self resetting) |
| Max. applied voltage to sunshine status output, | 0 to 24 V |
| RS232 connector | M12 5-way male |
| Analogue Signal output, warm-up & sensor power in and heater connector | M12 8-way male |
| Heater output below 0°C | 15W |
| Heater output above 5°C | 2W reducing to 0W at 35°C |
| Lowest snow & ice-free temperatures (using heater) | -20°C at 0 m/s wind speed -10°C at 2 m/s wind speed |
| Heater: max. power | 15W at 12V DC |
| Heater: max. current | 1.5A at 15V |
| Fuse: max voltage, current | 24V, 1.6A (self resetting) |
| Heater Input Voltage range | 12-15V DC |
| Mounting options: | ¼ inch British Standard Whitworth camera tripod socket. Holes for 4x M4 bolts at corners of box |
| Size & Weight | 120mm x 122mm x 95mm, 635 gm |

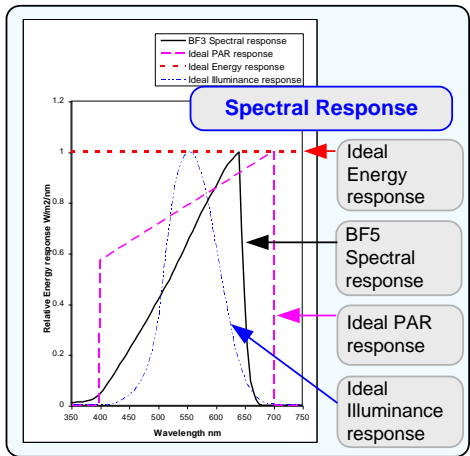
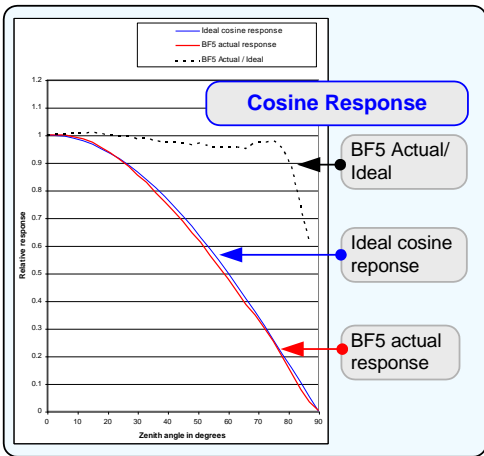

Delta-T Devices Ltd
130 Low Road, Burwell
Cambridge CB25 0EJ
UK

Tel: +44 1638 742922
Fax: +44 1638 743155
e-mail: sales@delta-t.co.uk
web: www.delta-t.co.uk