

# DL2e Data Logger

*64 Channel Research-Grade Logger with support for a comprehensive range of sensors*

## **Quick Start Guide** Version 2.1



**AT** Delta-T Devices Ltd

# Unpacking

Check your contents against your order and any packing lists. You should have:

- ▶ DL2e fitted with any of the following options:
  - input cards LAC1
  - case height extensions if ordered
- ▶ Ls2Win PC software on CD and Tutorial Kit
- ▶ Serial cable type LRS1 for DL2e to PC communication.
- ▶ Spares and Accessory pack

The following optional accessories are supplied packed separately (if ordered)

- ▶ Rechargeable battery pack type LBK1
- ▶ Battery charger

Many compatible sensors are available – too many to list here!

# Overview

The DL2e can log up to 128,000 readings on up to 64 channels. It has a wide choice of input cards for recording DC & AC voltage, resistance, counts, frequency and status. The software is easy to use and supports most sensors. Automatic data collection is possible from remote sites with a permanent RS232 connection. It is battery powered, weatherproof, rugged and portable. Weather station packages and evapo-transpiration software are available.

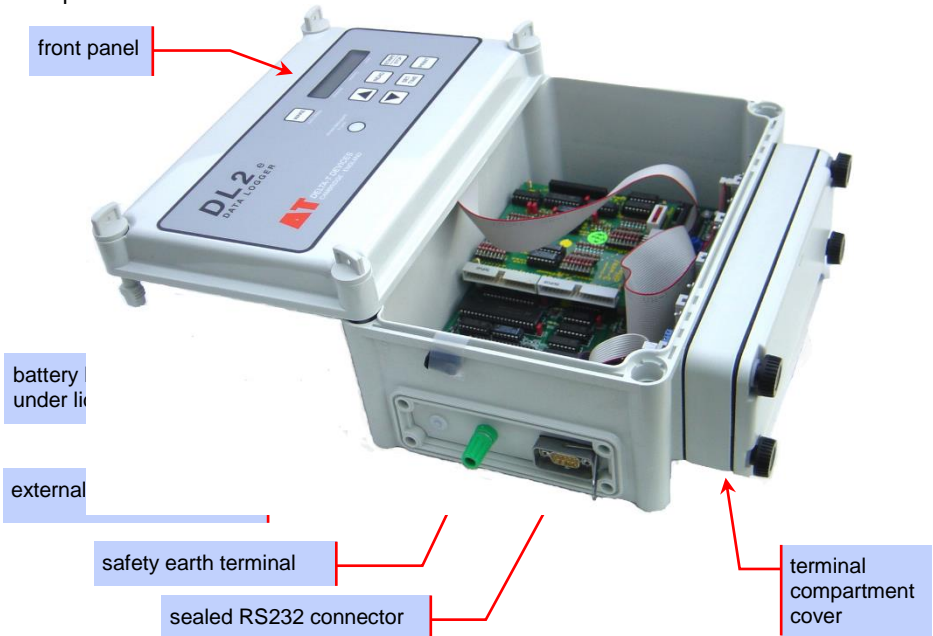

# Overview

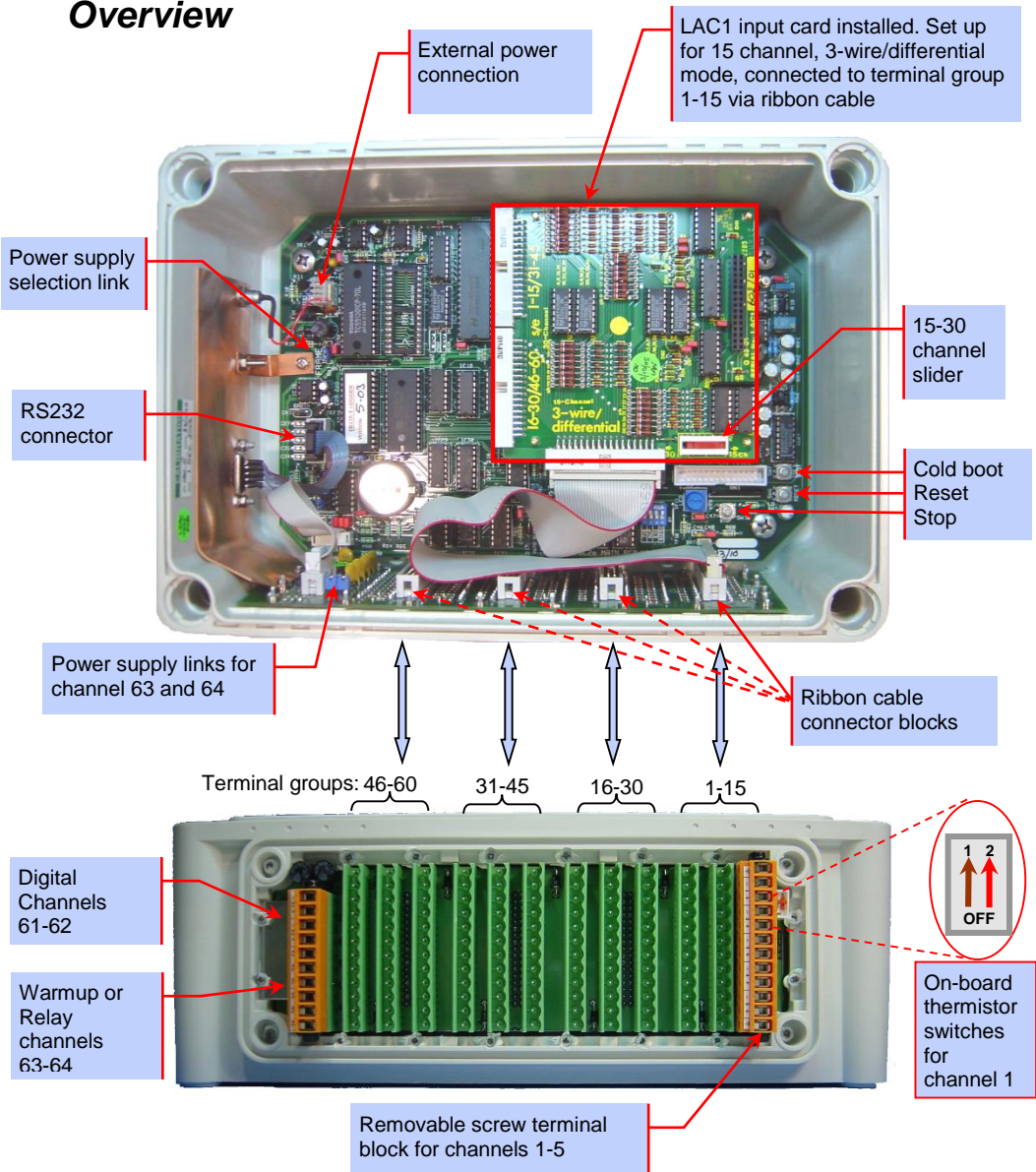

# Install Ls2Win

What you need:

- A PC running Windows 98, Me, 2000, XP, or a later version
- Microsoft Excel 97 or later for the Excel Dataset Import Wizard
- One free RS232 serial port, or USB-RS232 adapter
- DVD drive for software installation
- A minimum of 10MB of available hard disk space
- DL2e to PC RS232 cable (supplied with DL2e).
- Ls2Win software distribution disk (supplied with DL2e)
- Acrobat Reader for reading documentation (free download from [www.adobe.com](http://www.adobe.com)).

To install Ls2Win:

1. Insert the distribution disk into your CD drive.
2. If the Setup program doesn't start automatically, run **Setup.exe** on the CD.

Setup installs a program group named **Ls2Win** on the Programs menu, including the following:

- **Online Documents** folder - note the **Release Notes** and **Hardware Reference**
- **New DL2 Control Panel**, to communicate with your logger
- **DL2 Program Editor**, to create and view logging programs
- **Dataset Viewer**, to inspect files containing files of logged data
- **Dataset Import Wizard**, to import data into Microsoft Excel.

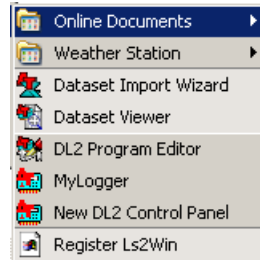

## Start New DL2 Control Panel

1. Connect the DL2 to the PC's serial port using the supplied serial cable.
2. Double click on the **New DL2 Control Panel** icon on your desktop.
3. A **DL2 Connections Properties** dialog box will open. Click **Help** for comprehensive online Help. Click **OK** to accept the default settings offered. The default RS232 port is COM1. If using a USB adapter use the Device Manager to identify the correct COM port.
4. A **Save DL2 Control Panel As** dialog appears..
5. Click **Save** to accept the default MyLogger.dl2 file name.

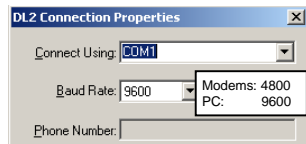

The control panel now creates a shortcut to itself on the desktop and retrieves and displays status information about the logger.

Logging program status:  
Standing By, Armed, Logging or stopped

Refreshes the displayed information

Start logging

Retrieves the program, not the data

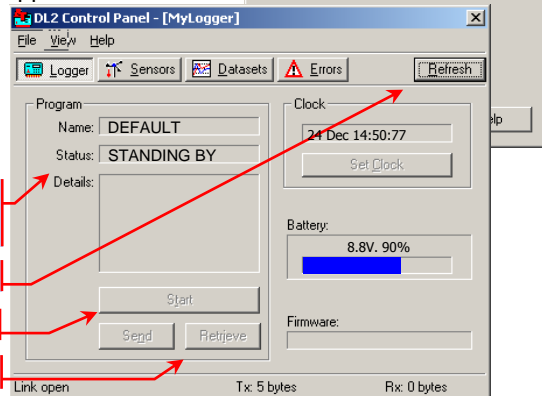

# Tutorial

## 1) Sensor wiring help

1. Start the **DL2e Program Editor**.
2. Select **Sensor Library**.
3. Scroll down to and click on any sensor. An **Application Notes** window will open with wiring instructions for each sensor and input card.
4. See if you can find suitable instructions for the components in the Tutorial kit.

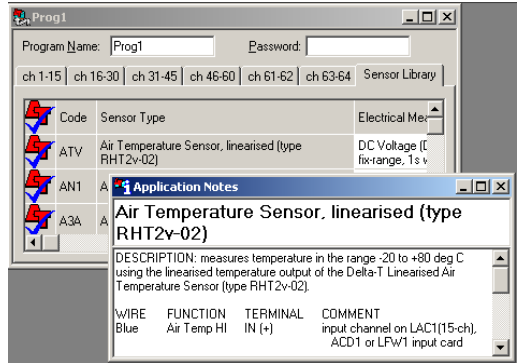

## 2) Connect Tutorial Kit sensors

1. Remove the sensor terminal blocks from the side of the logger, and attach the Tutorial Kit components as shown here, using the screwdriver provided:-

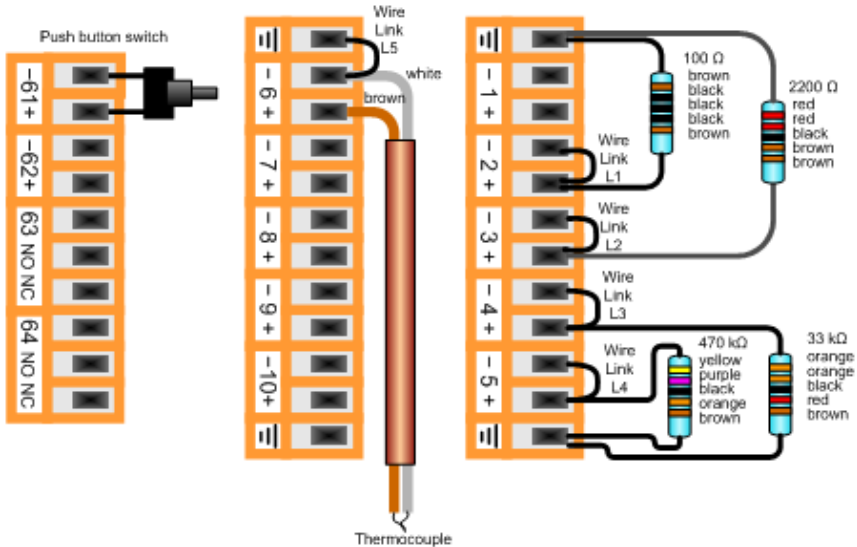

2. Plug the terminal blocks back in to the terminal panel.
3. Set the two slider switches UP to the ON position (top right of terminal board) to connect channel 1 to a thermistor on the terminal board. It can be used as the cold junction reference for thermocouples.

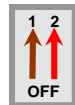

## 3) Set up LAC1 Input Card

Open the logger and ensure that:

- ▶ an LAC1 card is installed with slider switch set to 15-Ch
- ▶ a ribbon cable connects from the 15 channel terminal on the LAC1 card to the terminal block for channels 1-15 inside the logger.

## 4) Select DEFAULT logging program

Check the Program name in the **DL2 Control Panel** on the **Logger** page.

If it is a new Logger, skip to (5).

Otherwise ensure that any logged data and programs are saved using the **File, Save As** command, then **cold boot** the logger.

### *To cold boot the logger*

Open the logger case and hold down the **COLD BOOT** and **STOP** buttons on the main circuit board.

If the logger is asleep, also press **WAKE** on the logger's keypad.

While the logger is awake, also press and release the **RESET** button on the main circuit board.

The message "coldbooting.." appears on the logger's display, followed by a sequence of reports as the logger checks RAM chips, installs a **DEFAULT** logging program and goes to sleep.

## 5) Inspect the Sensor Readings

Before logging data, always check the sensors readings are OK.

### *Check readings via the DL2 keypad and LCD*

1. Wait for the logger to sleep.
2. Press **WAKE** and interrupt the General Status Report by pressing **READ** almost immediately.

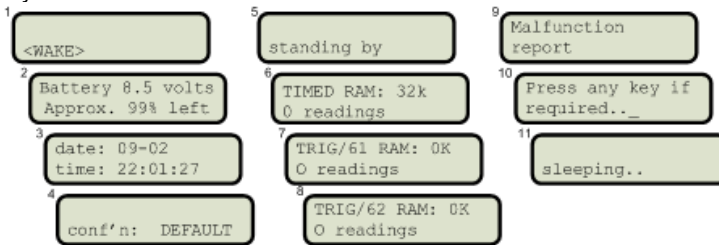

*General Status Report message sequence on keypad after WAKE*

3. On "Press any key if required..", press **READ** again to display channel 1 readings.

4. Press **▼** and **▲** to scroll through and inspect all the programmed channels. Note: The underline cursor **\_** indicates which channel is active.

For further details on keypad operations see the **DL2 Hardware Reference** in the **Online Documents Folder**.

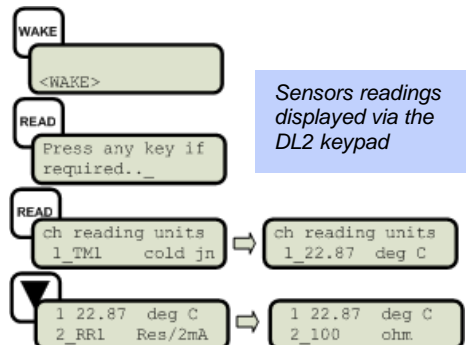

*Sensors readings displayed via the DL2 keypad*

## Check readings via the DL2 Control Panel

1. Wait until the logger sleeps before you try to communicate via the PC.
2. Double click on the **My Logger** desktop icon to open the **DL2 Control Panel**.
3. Click **Sensors** in the **DL2 Control Panel**.
4. Enable **Read Continuously** and click **Select All**, and **Read Now**.
5. Touch the thermocouple tip and observe channel 6. The sensitivity is ~ 0.04 mV/°C temperature difference between the thermocouple junction and the cold junction.

Note: The resistors supplied are  $\pm 1\%$  so readings may differ a little from the nominal values.

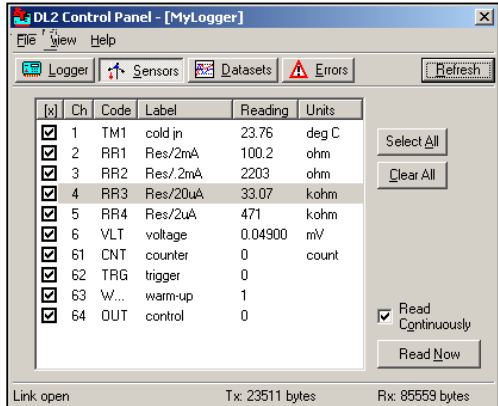

*Sensors panel showing real-time readings from the Tutorial Kit using DEFAULT logging*

## 6) Reprogram the Logger

1. On the **Logger** panel of the **DL2 Control Panel** click **Retrieve** to upload a copy of the existing **DEFAULT** program in the logger. An **Application Notes** box also opens.

2. Examine the **ch 1-15** tab. Each row represents a channel.
3. You have to tell the logger which input card is connected to each terminal group.

Select **LAC1, 15** channel.

4. Double click on channel 6 to open the **Sensor Type Properties** dialog.
5. From the **Sensor Type** drop down list on the **Input Channels** tab, select **Thermocouple: Copper Constantan (type T)**.
6. Type in a new label of up to 8 characters e.g. "Temp".
7. Select channel 1 for the **Cold Junction Channel**.

(A cold junction is needed by all thermocouples. A built-in thermistor is provided on channel 1).

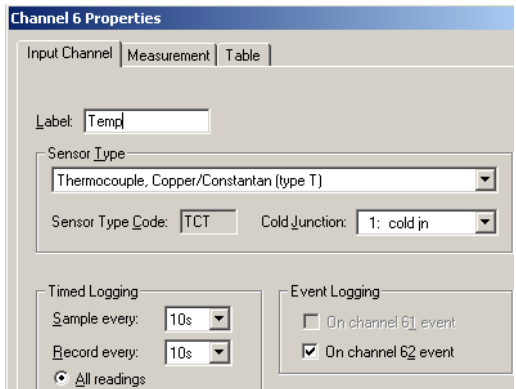
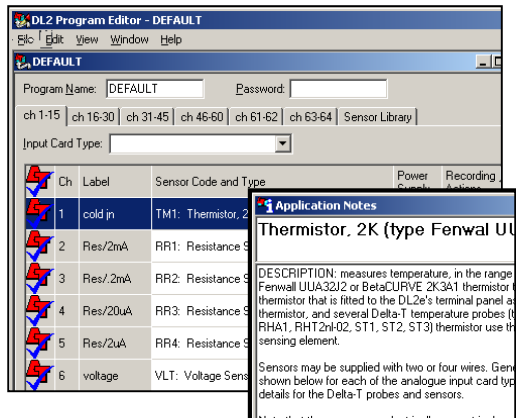



8. Click **OK** and inspect channel 6. It is now configured to read type T copper-constantan thermocouples.
  9. We do not need channel 62 configured as a Data Trigger. Select the **Ch 61-62** tab. Highlight Channel 62 and click **Delete** (on your keyboard).
  10. We also do not need channel 64 as a Warm-up channel. Select the **Ch 63-64** tab. Highlight channel 64 and delete this also.
  11. Return to the **Ch 1-15** tab, highlight channel 6. Note that the **Recording Actions** column has changed.
  12. Enter a **Program Name** of up to 8 characters.
  13. Select **File, Save As** and save your new logging program with a unique **File name**.
  14. Select **File, Send to DL2** to display a choice of DL2 Control Panels.
  15. Select the name of your current DL2 Control Panel, e.g. My Logger.
- Your chosen Control Panel should then open and the logging program will be sent to your logger.
16. Check your new program name appears on the **Logger** panel

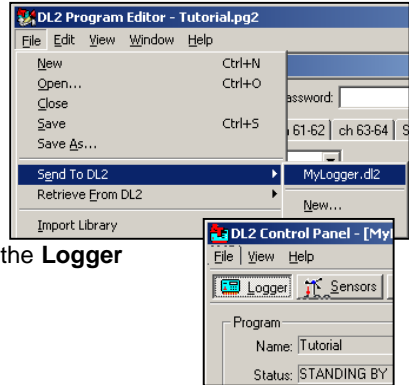

## 7) Start Logging

1. Open the **DL2 Control Panel** by double clicking on the **My Logger** icon on your desktop.

On the **Logger** panel click on **Start** to display the **Start Logging** dialog. The start can be deferred until a set time or until a logic condition is met on the counter channels 61 or 62.

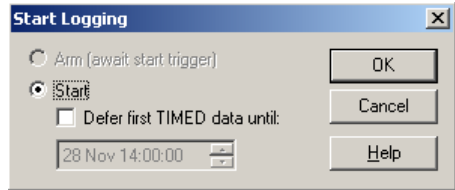

2. Click **OK** to start immediately.

Note: you can click on the **Sensors** panel and check your sensor readings even when the logger is logging.

## 8) Retrieve Logged Datasets

1. Leave your logger logging for a few minutes to create some data
2. On the **Dataset** panel click **Refresh** to update the display showing how many readings are stored.

3. On the **Dataset** panel click **Retrieve** to display the **Retrieve Dataset** dialog.

4. Click **OK** to retrieve all the data.

5. A **Save As** dialog appears. Select a suitable folder and file name and type.

Note the default binary format is quickest (with .bin after the filename).

6. Click **Save** to copy the dataset to your PC

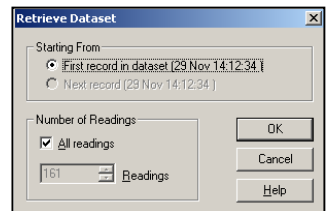



Channel	61	1	2	3	4	5	6
Label	counter	cold in	Res/2mA	Res/.2mA	Res/20uA	Res/2uA	Temp
Sensor Type	CNT	TM1	RR1	RR2	RR3	RR4	TCT
Units	count	deg C	ohm	ohm	kohm	kohm	deg C
29 Nov 15:03:01	0.000000	25.530000	100.160000	2201.600000	33.049600	471.552000	27.290000
29 Nov 15:03:11	0.000000	25.540000	100.160000	2201.600000	33.049600	471.552000	27.170000
29 Nov 15:03:21	0.000000	25.530000	100.192000	2201.600000	33.049600	471.552000	27.140000
29 Nov 15:03:31	0.000000	25.540000	100.160000	2201.600000	33.049600	471.552000	27.070000

Dataset retrieved from logger to file and displayed as a table

## Dataset Import Wizard

Dataset Import Wizard helps you seamlessly import data into MS Excel spreadsheets. Multiple dataset files may be imported and the data interleaved.

### To Install Dataset Import Wizard:

1. Select **Start, Programs, Ls2Win, Install Dataset Import Wizard.**
2. If prompted by Excel, select **Enable Macro's**. Note that Excel's security settings must allow macros to run: refer to Excel Help.
3. Dataset Import Wizard will report that it has installed successfully, and will add the Import Dataset(s) to the File menu.
4. To Start Dataset Import Wizard: Start Excel, select **ADD INS, Import Dataset(s)** from the menu, and follow the on-screen instructions.
5. Look for DL2 Dataset Files of type: \*.bin, \*.hfd or \*.dat

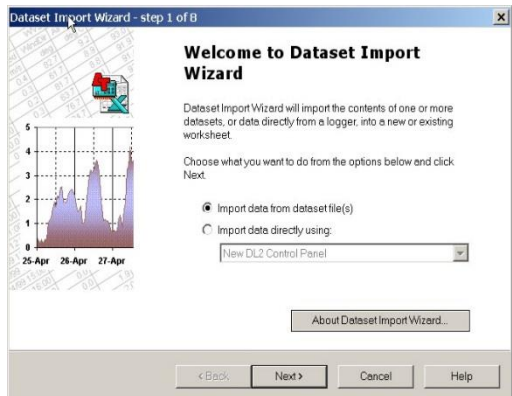

## Online Help

Note that LS2Win has a detailed online Help: click **Help** from any window (or press F1) for detailed information about operation and functionality.

Select the **Document Library** folder in the Ls2Win Program group to open a folder of application notes and technical documentation.

# SPECIFICATIONS

**LOGGING INTERVAL AND SPEED** 1, 5, 10, 30 seconds, 1, 5, 10, 30 minutes, or 1, 2, 4, 12 or 24 hours, programmable for each channel. Readings can also be reduced to averages, maxima or minima at these intervals. Typically 10 channels per second in total.

**INPUT CHANNELS** 60 channels maximum, depending on input cards installed, plus 2 resident digital inputs and 2 relay outputs.

## Analogue Inputs

**STANDARD ANALOGUE CARD, LAC1** Each LAC1 multiplexer card can select analogue inputs from:  
Either: 15 channels of differential voltages and/or 3-wire resistances  
Or: 30 channels of single-ended (common ground) voltages and/or 2-wire resistances  
Directly measures voltages up to  $\pm 2V$  or resistances  $< 1M\Omega$ . Voltages up to  $\pm 50V$  and currents can be measured using precision divider or shunt resistors mounted directly on the input screw terminals.

## VOLTAGE READINGS

		<b>Full Scale</b>	<b>Resolution (12 bits + sign)</b>
	4 ranges, user-selected or autoranged:	Range 1: $\pm 4mV$ Range 2: $\pm 32mV$ Range 3: $\pm 262mV$ Range 4: $\pm 2.097V$	$1\mu V$ $8\mu V$ $64\mu V$ $0.5mV$
<b>DC Accuracy</b> (typical figures in brackets)	<b>Logger temperature</b> Full scale error Long term stability Differential offset Noise Input impedance Common Mode Range Common Mode Rejection Ratio	<b>15 to 25°C -20 to +60°C</b> $\pm 0.07\%$ (0.04%) $\pm 0.2\%$ (0.1%) $\pm 0.25\%$ (0.02%) over 1 year $\pm 10\mu V$ (3 $\mu V$ ) $\pm 0.02\%$ $\pm 12\mu V$ $\pm 0.02\%$ (0.2 $\mu V$ rms) 100M $\Omega$ approx. $\pm 2V$ or $\pm 1.05V$ if "+" input is closer to logger 0V than "-" input (140dB), on voltage range 1	

**RESISTANCE READINGS** Auto-ranging 12-bit voltage readings with programmable 2, 20, 200 or 2000 $\mu$ A excitation, giving 1M $\Omega$  full scale, or better than 0.01 $\Omega$  resolution on lowest range

**Accuracy** As voltage readings, with additional errors:

<b>Logger temperature</b>	<b>15 to 25°C</b>	<b>-20 to +60°C</b>
2 $\mu$ A excitation	$\pm$ 0.3% reading	$\pm$ 0.6% reading (to +50°C)
other excitation currents	$\pm$ 0.05% reading	$\pm$ 0.1% reading
2-wire LAC1,	$\pm$ 5 $\Omega$ typical	$\pm$ 5 $\Omega$ typical

**INPUT PROTECTION** Analogue inputs withstand  $\pm$ 15V continuously, and much higher voltages in brief pulses (500V 1.2/50 $\mu$ s).

### Digital Inputs and Outputs

**DIGITAL INPUTS** All loggers have 2 resident 16-bit counter channels that continuously monitor logic levels or switch closures, logging digital status, counts or frequency (up to 100Hz), or for triggering special logging sequences

**RELAY OUTPUTS** 2 SPDT relays for powering up sensors, or for providing alarms or malfunction warnings. 1A, 24V rating.

### Other Specifications

**PROCESSING** The DL2e converts readings into engineering units using look-up tables or a linear conversion  $y = mx + c$ . User expandable sensor library includes Delta-T sensors (pages 15-18), Platinum Resistance Thermometers, Thermistors (Fenwal 2K, 2K252, 10K and 100K types), and Thermocouples (types J, K and T). Cold junction temperature is measured at isothermal terminals.

**DISPLAY** A 2-line LCD shows instantaneous output from any sensor (in engineering units if appropriate), time, battery and memory condition, and status messages, without disturbing logging.

**MEMORY** Highly reliable CMOS RAM, double battery-backed. Expandable from 64k readings (standard) to 128k. Automatic RAM check.

**DATA FORMAT** ASCII, easily loaded into many spreadsheets and other packages, e.g. Excel, Lotus 1-2-3. Transmitted readings are date/time stamped, and labelled in engineering units with errors flagged. Data files created by the LS2e software are comma separated.

**INTERFACE** RS-232 serial, up to 9600 baud. Up to 10000 readings transferred per minute without disturbing logging.

**POWER** 6 internal AA alkaline cells typically provide power for 500k readings, or 24 hours' operation using the keypad/LCD or RS-232 interface, or 12 months' quiescent operation. An external 7-15V DC supply can be used, with the alkaline batteries providing a back-up. The internal lithium cell will retain data for 2 months in the event of a power supply failure.

**ENVIRONMENTAL** Operating temperature: -20 to +60°C. IP65 weatherproof main case with desiccant and humidity indicator.

**EMC CONFORMITY** Tested to comply with EN 50081-1 and EN-50082-1 (1992) harmonised emissions and immunity standards

**SIZE/WEIGHT** 280 x 220 x 140mm / 2.7kg.

## **Product Care and Maintenance**

To keep the logger functioning properly:

- Keep the batteries and desiccant fresh.
- Avoid use beyond -20°C to +60°C.
- Avoid storage beyond -30°C to + 60°C.
- Don't leave the logger in direct strong sunlight.

### **Replacing batteries**

When replacing batteries:

- Use alkaline cells only. Other less expensive types of primary battery are not suitable. They can leak corrosive chemicals and cause permanent damage.
- Insert the batteries the right way round, as indicated on the battery holder.
- Always replace a complete set of batteries. Don't mix batteries that have been discharged by different amounts.

You can change batteries without stopping logging, but you must ensure that you can complete the procedure while the logger is asleep, between LOGs. If the logger's power supply is interrupted during a LOG, it may be unable to resume logging. If you need to change the batteries and continue to log data at frequent intervals, provide an external power supply while changing the batteries.

### **Storage**

If the logger is put away for storage for a long period of time, remove the main battery and the lithium cell and keep the logger in a dry place within -30°C to +60°C. When the logger is again required for use, replace the batteries and cold boot.

### **Regenerating desiccant**

Place the bags in an oven at 110-120°C for 7 hours (approx.) to regenerate expired desiccant. Exceeding this temperature may cause the glue sealing some types of desiccant package to melt. When the water has been driven off, remove the capsules or bags and seal them in a plastic bag to cool down, until they are ready for use.

## **Legal Notices**

This product uses software code. It should not be used in safety-critical applications or where consequential loss may occur. It is the responsibility of the user to ensure appropriate safeguards are in place for regularly monitoring and checking the equipment.

In no event shall Delta-T's liability exceed the selling price of the product. Delta-T is not liable for indirect, incidental or consequential damages in connection with the use of equipment, including but not limited to: data loss, vegetation loss, loss of energy or water, cost of substitute equipment or services, property damage, or personal injury that results from installer's negligence. The customer agrees to the limitations and exclusions of liability by purchase or use of this product.

The DL2 product is CE compliant, conforming to **EN61326 (1997)**. This device complies with part **15 of the FCC rules**. Operation is subject to the following conditions: (1) this device may not cause harmful interference, (2) this device must accept any interference received, including interference that may cause undesirable operation. Please ensure you read **Product Usage.pdf** in the **Document Library** folder.



Delta-T Devices Ltd  
130 Low Road, Burwell  
Cambridge CB25 0EJ  
UK

Tel: +44 1638 742922  
Fax: +44 1638 743155  
email: [sales@delta-t.co.uk](mailto:sales@delta-t.co.uk)  
web: [www.delta-t.co.uk](http://www.delta-t.co.uk)